

The RF Line

NPN Silicon

RF Low Power Transistor

MRF4427R2

Designed for amplifier, frequency multiplier, or oscillator applications in industrial equipment constructed with surface mount components. Suitable for use as output driver or pre-driver stages in VHF and UHF equipment.

- Low Cost SORF Plastic Surface Mount Package
- Guaranteed RF Specification — $|S_{21}|^2$
- S-Parameter Characterization
- Low Voltage Version of MRF3866
- Tape and Reel Packaging Available.
R2 suffix = 2,500 units per reel

1.0 W, 175 MHz
HIGH-FREQUENCY
TRANSISTOR
NPN SILICON

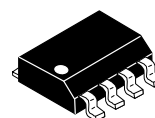

CASE 751-05, STYLE 1
SORF
(SO-8)

MAXIMUM RATINGS

Rating	Symbol	Value	Unit
Collector-Emitter Voltage	V_{CEO}	20	Vdc
Collector-Base Voltage	V_{CBO}	40	Vdc
Emitter-Base Voltage	V_{EBO}	2.0	Vdc
Collector Current — Continuous	I_C	400	mAdc
Total Device Dissipation @ $T_C = 75^\circ\text{C}$ Derate above 75°C	P_D	1.67 22.2	Watts mW/ $^\circ\text{C}$
Operating Junction and Storage Temperature Range	T_J, T_{stg}	-65 to +150	$^\circ\text{C}$

THERMAL CHARACTERISTICS

Characteristic	Symbol	Max	Unit
Thermal Resistance, Junction to Case	$R_{\theta JC}$	45	$^\circ\text{C/W}$

DEVICE MARKING

MRF4427 = 4427

ELECTRICAL CHARACTERISTICS ($T_A = 25^\circ\text{C}$ unless otherwise noted)

Characteristic	Symbol	Min	Typ	Max	Unit
Collector-Emitter Sustaining Voltage ($I_C = 5.0$ mAdc, $I_B = 0$)	$V_{(BR)CEO}$	20	—	—	Vdc
Collector-Emitter Breakdown Voltage ($I_C = 5.0$ mAdc, $R_{BE} = 10$ ohms)	$V_{(BR)CER}$	40	—	—	Vdc
Emitter-Base Breakdown Voltage ($I_E = 100$ μ Adc)	$V_{(BR)EBO}$	2.0	—	—	Vdc
Collector Cutoff Current ($V_{CE} = 12$ Vdc, $I_B = 0$)	I_{CEO}	—	—	20	μ Adc

NOTE:

1. Case temperature measured on collector lead immediately adjacent to body of package.

(continued)

ELECTRICAL CHARACTERISTICS — continued ($T_A = 25^\circ\text{C}$ unless otherwise noted)

Characteristic	Symbol	Min	Typ	Max	Unit
ON CHARACTERISTICS					
DC Current Gain ($I_C = 100\text{ mA}$, $V_{CE} = 5.0\text{ Vdc}$) ($I_C = 360\text{ mA}$, $V_{CE} = 5.0\text{ Vdc}$)	h_{FE}	10 5.0	50 —	200 —	—
Collector–Emitter Saturation Voltage ($I_C = 100\text{ mA}$, $I_B = 20\text{ mA}$)	$V_{CE(sat)}$	—	60	—	mVdc

DYNAMIC CHARACTERISTICS

Current–Gain — Bandwidth Product ($I_C = 50\text{ mA}$, $V_{CE} = 12\text{ Vdc}$, $f = 200\text{ MHz}$)	f_T	—	1600	—	MHz
Output Capacitance ($V_{CB} = 12\text{ Vdc}$, $I_E = 0$, $f = 1.0\text{ MHz}$)	C_{ob}	—	—	3.0	pF

FUNCTIONAL TESTS

Common–Emitter Amplifier Power Gain ($P_{in} = 15\text{ mW}$, $V_{CC} = 12\text{ Vdc}$, $f = 175\text{ MHz}$)	G_{pe}	—	18	—	dB
Collector Efficiency (Figure 1) ($P_{out} = 1.0\text{ W}$, $V_{CC} = 12\text{ Vdc}$, $f = 175\text{ MHz}$)	η	—	60	—	%
Insertion Gain ($V_{CE} = 12\text{ Vdc}$, $I_C = 50\text{ mA}$, $f = 200\text{ MHz}$)	$ S_{21} ^2$	14	16.4	—	dB

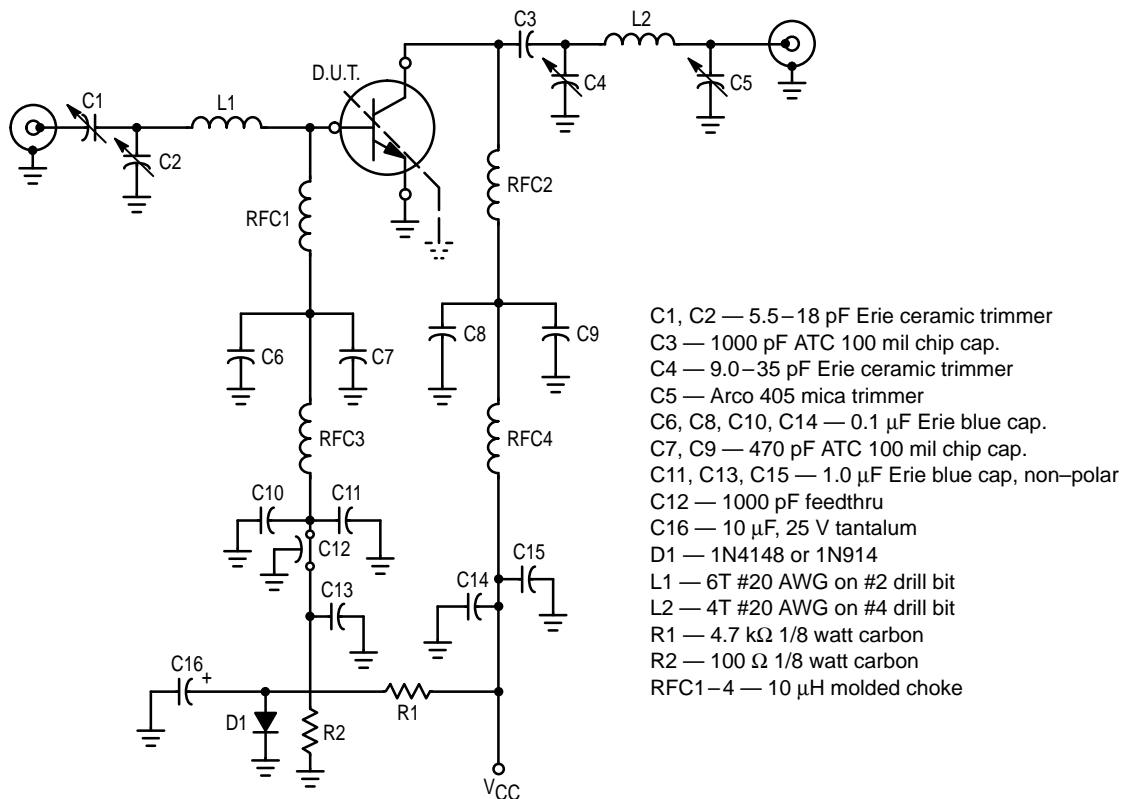

Figure 1. 175 MHz RF Amplifier Circuit for Functional Tests

TYPICAL CHARACTERISTICS

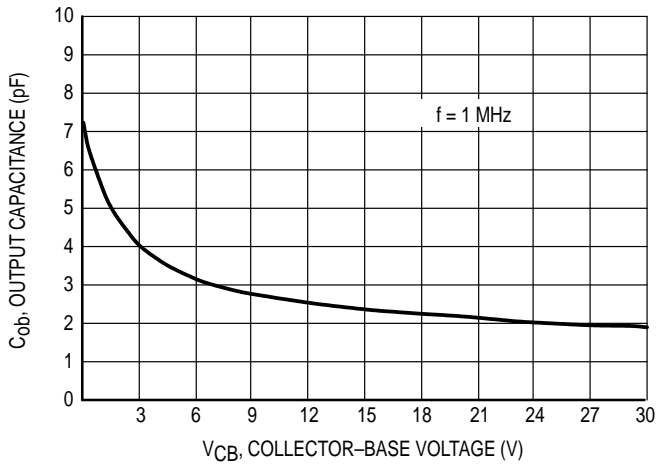

Figure 2. Collector-Base Capacitance versus Voltage

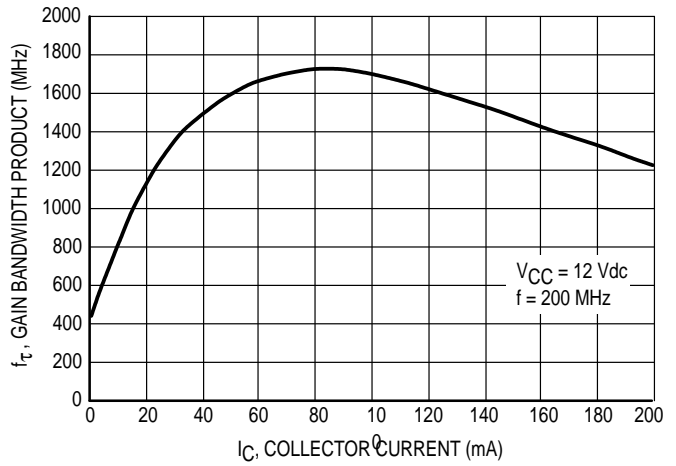

Figure 3. Gain Bandwidth Product versus Collector Current

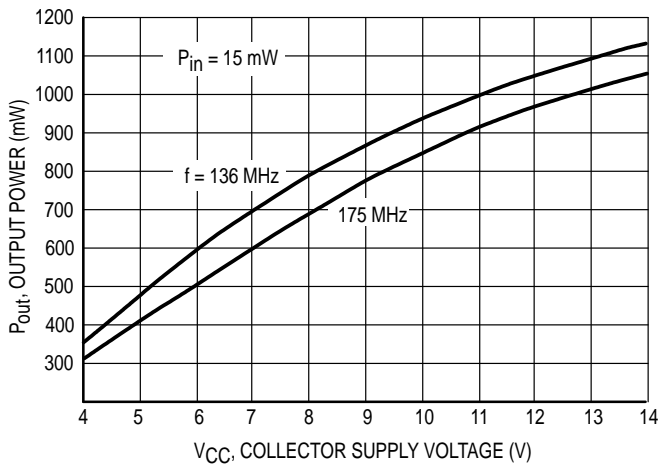

Figure 4. Output Power versus Voltage

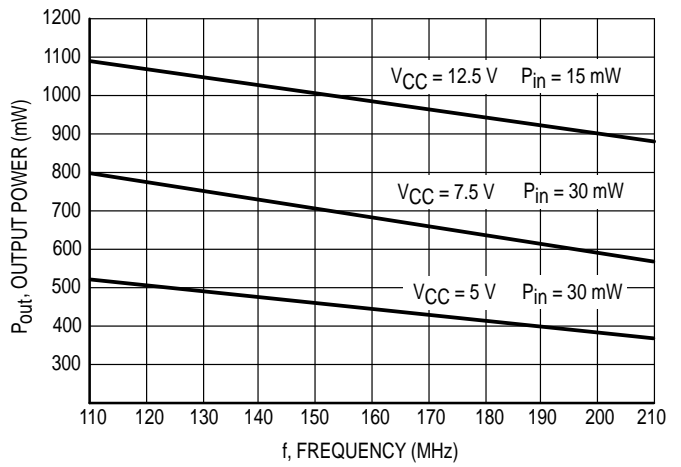

Figure 5. Output Power versus Frequency

V _{CE} (Volts)	I _C (mA)	f (MHz)	S ₁₁		S ₂₁		S ₁₂		S ₂₂	
			S ₁₁	∠φ	S ₂₁	∠φ	S ₁₂	∠φ	S ₂₂	∠φ
5.0	5.0	50	0.82	-104	10.3	125	0.05	38	0.68	-34
		100	0.83	-141	6.1	103	0.06	26	0.51	-40
		200	0.81	-165	3.2	85	0.07	21	0.44	-46
		500	0.80	169	1.3	57	0.07	32	0.49	-73
		750	0.79	156	0.8	42	0.08	49	0.58	-94
		1000	0.76	144	0.6	30	0.11	61	0.65	-114
	25	50	0.77	-151	19	107	0.02	36	0.35	-75
		100	0.79	-168	9.9	94	0.03	37	0.21	-87
		200	0.79	-180	5.0	82	0.04	49	0.16	-97
		500	0.78	163	2.0	61	0.07	62	0.22	-106
		750	0.77	152	1.3	48	0.10	66	0.31	-115
		1000	0.74	141	0.9	36	0.13	66	0.37	-127
	50	50	0.77	-163	21.1	103	0.02	37	0.29	-98
		100	0.79	-174	10.7	92	0.02	50	0.19	-119
		200	0.79	177	5.4	82	0.03	62	0.16	-134
500		0.78	162	2.2	62	0.07	67	0.20	-131	
750		0.77	151	1.4	50	0.10	69	0.26	-130	
1000		0.74	140	1.1	38	0.13	67	0.32	-139	
12	5.0	50	0.83	-97	11	129	0.04	46	0.75	-26
		100	0.82	-135	6.8	107	0.05	29	0.61	-29
		200	0.81	-162	3.6	88	0.05	24	0.54	-34
		500	0.79	171	1.4	60	0.06	37	0.47	-57
		750	0.78	157	0.9	44	0.07	55	0.64	-76
		1000	0.75	145	0.7	32	0.09	68	0.70	-95
	25	50	0.73	-143	22.1	111	0.02	38	0.43	-52
		100	0.76	-164	11.7	96	0.02	39	0.29	-52
		200	0.77	-177	6.0	84	0.03	48	0.22	-53
		500	0.76	165	2.4	63	0.06	64	0.27	-69
		750	0.75	154	1.6	49	0.08	67	0.35	-84
		1000	0.72	143	1.1	38	0.11	69	0.42	-98
	50	50	0.73	-156	25.5	106	0.02	41	0.32	-67
		100	0.75	-171	13.1	94	0.02	49	0.20	-69
		200	0.76	59	6.6	83	0.03	60	0.15	-71
500		0.75	164	2.6	64	0.06	69	0.20	-81	
750		0.74	153	1.7	51	0.09	70	0.27	-92	
1000		0.71	142	1.2	38	0.12	70	0.34	-104	

Table 1. Common Emitter S-Parameters

Freq. (MHz)	P _{in} (mW)	P _{out} (mW)	V _{CC} (Volts)	Z _{in} (Ohms)	Z _{OL} * (Ohms)
136	15	—	12.5	6.2 - j11.6	—
175	15	—	12.5	4.6 - j10.4	—
136	—	1000	12.5	—	47.7 + j41.7
175	—	1000	12.5	—	47.4 - j34.4
136	30	—	7.5	5.65 - j12.6	—
175	30	—	7.5	6.25 - j12.2	—
136	—	650	7.5	—	27.6 - j32.4
175	—	650	7.5	—	27.9 - j27.6
136	30	—	5.0	6.1 - j13.3	—
175	30	—	5.0	5.9 - j12.22	—
136	—	450	5.0	—	24.8 - j22.8
175	—	450	5.0	—	28.3 - j29.3

Z_{OL}* = Conjugate of the optimum load impedance into which the device output operates at a given output power, voltage and frequency.

Table 2. Series Input/Output Impedances

PACKAGE DIMENSIONS

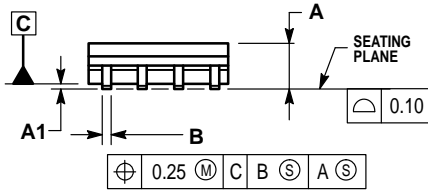
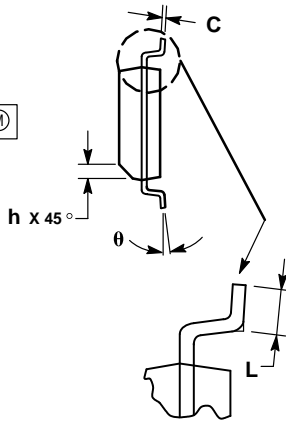
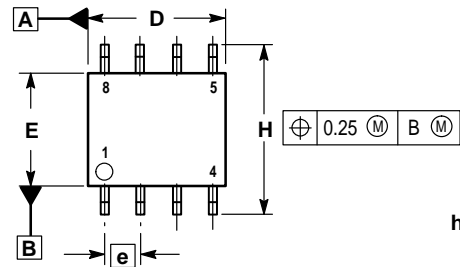

NOTES:

1. DIMENSIONING AND TOLERANCING PER ASME Y14.5M, 1994.
2. DIMENSIONS ARE IN MILLIMETERS.
3. DIMENSION D AND E DO NOT INCLUDE MOLD PROTRUSION.
4. MAXIMUM MOLD PROTRUSION 0.15 PER SIDE.
5. DIMENSION B DOES NOT INCLUDE MOLD PROTRUSION. ALLOWABLE DAMBAR PROTRUSION SHALL BE 0.127 TOTAL IN EXCESS OF THE B DIMENSION AT MAXIMUM MATERIAL CONDITION.

DIM	MILLIMETERS	
	MIN	MAX
A	1.35	1.75
A1	0.10	0.25
B	0.35	0.49
C	0.18	0.25
D	4.80	5.00
E	3.80	4.00
e	1.27 BSC	
H	5.80	6.20
h	0.25	0.50
L	0.40	1.25
θ	0°	7°

- STYLE 1:
- PIN 1. EMITTER
 2. COLLECTOR
 3. COLLECTOR
 4. EMITTER
 5. EMITTER
 6. BASE
 7. BASE
 8. EMITTER

**CASE 751-05
ISSUE S**

Motorola reserves the right to make changes without further notice to any products herein. Motorola makes no warranty, representation or guarantee regarding the suitability of its products for any particular purpose, nor does Motorola assume any liability arising out of the application or use of any product or circuit, and specifically disclaims any and all liability, including without limitation consequential or incidental damages. "Typical" parameters which may be provided in Motorola data sheets and/or specifications can and do vary in different applications and actual performance may vary over time. All operating parameters, including "Typicals" must be validated for each customer application by customer's technical experts. Motorola does not convey any license under its patent rights nor the rights of others. Motorola products are not designed, intended, or authorized for use as components in systems intended for surgical implant into the body, or other applications intended to support or sustain life, or for any other application in which the failure of the Motorola product could create a situation where personal injury or death may occur. Should Buyer purchase or use Motorola products for any such unintended or unauthorized application, Buyer shall indemnify and hold Motorola and its officers, employees, subsidiaries, affiliates, and distributors harmless against all claims, costs, damages, and expenses, and reasonable attorney fees arising out of, directly or indirectly, any claim of personal injury or death associated with such unintended or unauthorized use, even if such claim alleges that Motorola was negligent regarding the design or manufacture of the part. Motorola and  are registered trademarks of Motorola, Inc. Motorola, Inc. is an Equal Opportunity/Affirmative Action Employer.

Mfax is a trademark of Motorola, Inc.

How to reach us:

USA/EUROPE/Locations Not Listed: Motorola Literature Distribution;
P.O. Box 5405, Denver, Colorado 80217. 303-675-2140 or 1-800-441-2447

JAPAN: Nippon Motorola Ltd.: SPD, Strategic Planning Office, 4-32-1,
Nishi-Gotanda, Shinagawa-ku, Tokyo 141, Japan. 81-3-5487-8488

Mfax™: RMFAX0@email.sps.mot.com – TOUCHTONE 602-244-6609
– US & Canada ONLY 1-800-774-1848

ASIA/PACIFIC: Motorola Semiconductors H.K. Ltd.; 8B Tai Ping Industrial Park,
51 Ting Kok Road, Tai Po, N.T., Hong Kong. 852-26629298

INTERNET: <http://motorola.com/sps>



MRF4427/D