

# The RF Line

## NPN Silicon

### RF Power Transistor

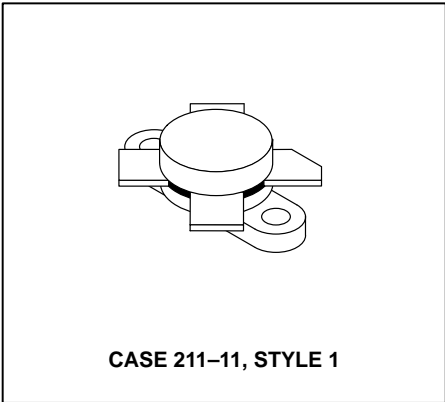
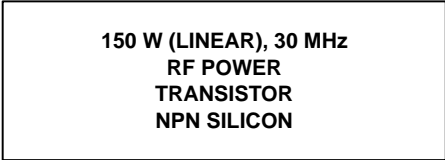

Designed primarily for high-voltage applications as a high-power linear amplifier from 2.0 to 30 MHz. Ideal for marine and base station equipment.

- Specified 50 Volt, 30 MHz Characteristics —  
Output Power = 150 W (PEP)  
Minimum Gain = 13 dB  
Efficiency = 45%
- Intermodulation Distortion @ 150 W (PEP) —  
IMD = -32 dB (Max)
- Diffused Emitter Resistors for Superior Ruggedness
- 100% Tested for Load Mismatch at all Phase Angles with 30:1 VSWR @ 150 W CW

#### MAXIMUM RATINGS

Rating	Symbol	Value	Unit
Collector-Emitter Voltage	$V_{CEO}$	50	Vdc
Collector-Base Voltage	$V_{CBO}$	100	Vdc
Emitter-Base Voltage	$V_{EBO}$	4.0	Vdc
Collector Current — Continuous	$I_C$	16	Adc
Withstand Current — 10 s	—	20	Adc
Total Device Dissipation @ $T_C = 25^\circ\text{C}$ Derate above $25^\circ\text{C}$	$P_D$	233 1.33	Watts W/ $^\circ\text{C}$
Storage Temperature Range	$T_{stg}$	-65 to +150	$^\circ\text{C}$

#### THERMAL CHARACTERISTICS

Characteristic	Symbol	Max	Unit
Thermal Resistance, Junction to Case	$R_{\theta JC}$	0.75	$^\circ\text{C}/\text{W}$

#### ELECTRICAL CHARACTERISTICS ( $T_C = 25^\circ\text{C}$ unless otherwise noted.)

Characteristic	Symbol	Min	Typ	Max	Unit
----------------	--------	-----	-----	-----	------

#### OFF CHARACTERISTICS

Collector-Emitter Breakdown Voltage ( $I_C = 200 \text{ mAdc}$ , $I_B = 0$ )	$V_{(BR)CEO}$	50	—	—	Vdc
Collector-Emitter Breakdown Voltage ( $I_C = 100 \text{ mAdc}$ , $V_{BE} = 0$ )	$V_{(BR)CES}$	100	—	—	Vdc
Collector-Base Breakdown Voltage ( $I_C = 100 \text{ mAdc}$ , $I_E = 0$ )	$V_{(BR)CBO}$	100	—	—	Vdc
Emitter-Base Breakdown Voltage ( $I_E = 10 \text{ mAdc}$ , $I_C = 0$ )	$V_{(BR)EBO}$	4.0	—	—	Vdc

(continued)

**ELECTRICAL CHARACTERISTICS — continued** ( $T_C = 25^\circ\text{C}$  unless otherwise noted.)

Characteristic	Symbol	Min	Typ	Max	Unit
<b>ON CHARACTERISTICS</b>					
DC Current Gain ( $I_C = 5.0 \text{ Adc}$ , $V_{CE} = 5.0 \text{ Vdc}$ )	$h_{FE}$	10	30	80	—
<b>DYNAMIC CHARACTERISTICS</b>					
Output Capacitance ( $V_{CB} = 50 \text{ Vdc}$ , $I_E = 0$ , $f = 1.0 \text{ MHz}$ )	$C_{ob}$	—	220	300	pF
<b>FUNCTIONAL TESTS</b>					
Common-Emitter Amplifier Gain ( $V_{CC} = 50 \text{ Vdc}$ , $P_{out} = 150 \text{ W (PEP)}$ , $I_C(\text{max}) = 3.32 \text{ Adc}$ , $f = 30$ ; 30.001 MHz)	$G_{PE}$	13	15	—	dB
Output Power ( $V_{CE} = 50 \text{ Vdc}$ , $f = 30$ ; 30.001 MHz)	$P_{out}$	150	—	—	W (PEP)
Collector Efficiency ( $V_{CC} = 50 \text{ Vdc}$ , $P_{out} = 150 \text{ W (PEP)}$ , $I_C(\text{max}) = 3.32 \text{ Adc}$ , $f = 30$ , 30.001 MHz)	$\eta$	45	—	—	%
Intermodulation Distortion (1) ( $V_{CE} = 50 \text{ Vdc}$ , $P_{out} = 150 \text{ W (PEP)}$ , $I_C = 3.32 \text{ Adc}$ )	IMD	—	-35	-32	dB
Electrical Ruggedness ( $V_{CC} = 50 \text{ Vdc}$ , $P_{out} = 150 \text{ W CW}$ , $f = 30 \text{ MHz}$ , VSWR 30:1 at all Phase Angles)	$\psi$	No Degradation in Output Power			

**NOTE:**

- To Mil-Std-1311 Version A, Test Method 2204, Two Tone, Reference each Tone.

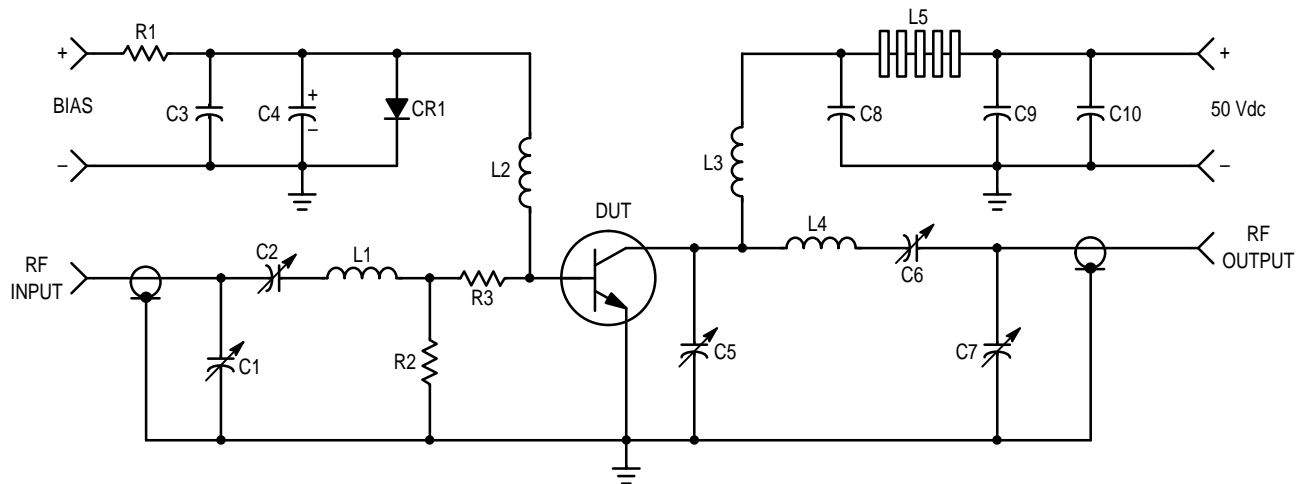

C1, C2, C7 — 170–780 pF, Arco 469  
 C3, C8, C9 — 0.1  $\mu\text{F}$ , 100 V Erie  
 C4 — 500  $\mu\text{F}$  @ 6.0 V  
 C5 — 9.0–180 pF, Arco 463  
 C6 — 80–480 pF, Arco 466  
 C10 — 30  $\mu\text{F}$ , 100 V  
 R1 — 10  $\Omega$ , 10 Watt

R2 — 10  $\Omega$ , 1.0 Watt  
 R3 — 5.0–3.3  $\Omega$  1/2 Watt Carbon Resistors in Parallel  
 CR1 — 1N4997  
 L1 — 3 Turns, #16 Wire, 5/16" I.D., 5/16" Long  
 L2 — 10  $\mu\text{H}$  Molded Choke  
 L3 — 12 Turns, #16 Enameled Wire Closewound, 1/4" I.D.  
 L4 — 5 Turns, 1/8" Copper Tubing, 9/16" I.D., 3/4" Long  
 L5 — 10 Ferrite Beads — Ferroxcube #56–590–65/3B

**Figure 1. 30 MHz Test Circuit Schematic**

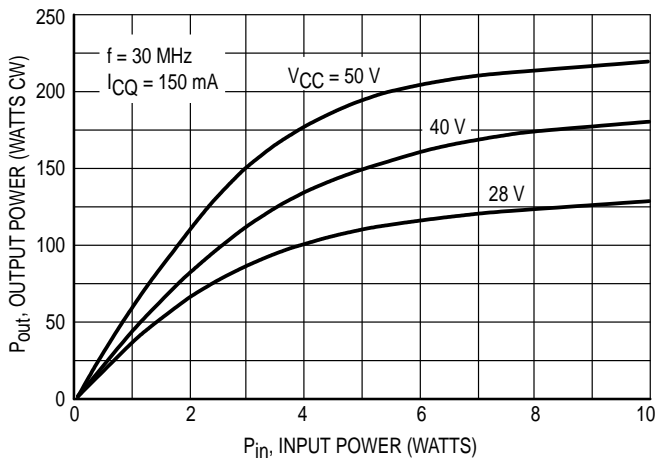

Figure 2. Output Power versus Input Power

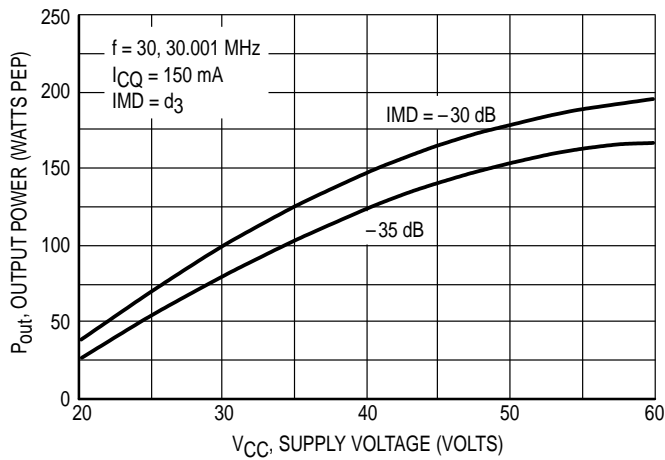

Figure 3. Output Power versus Supply Voltage

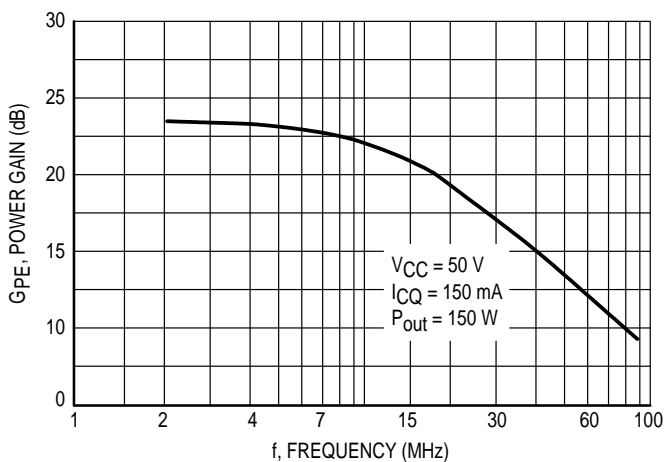

Figure 4. Power Gain versus Frequency

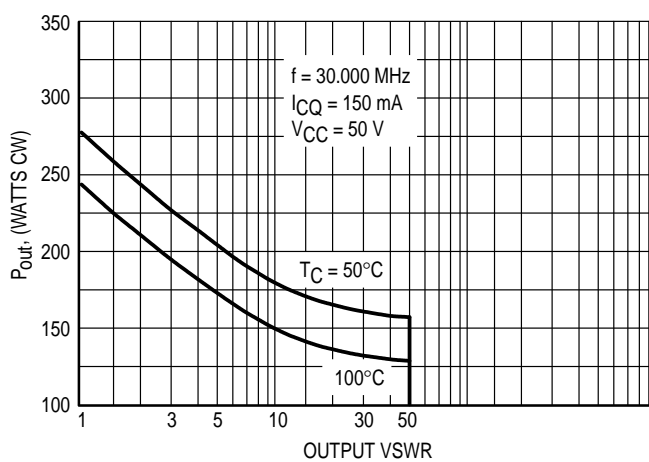

Figure 5. RF Safe Operating Area (SOAR)

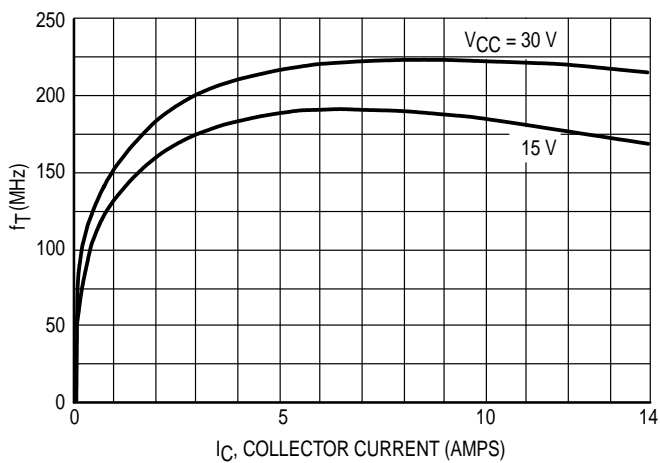

Figure 6.  $f_T$  versus Collector Current

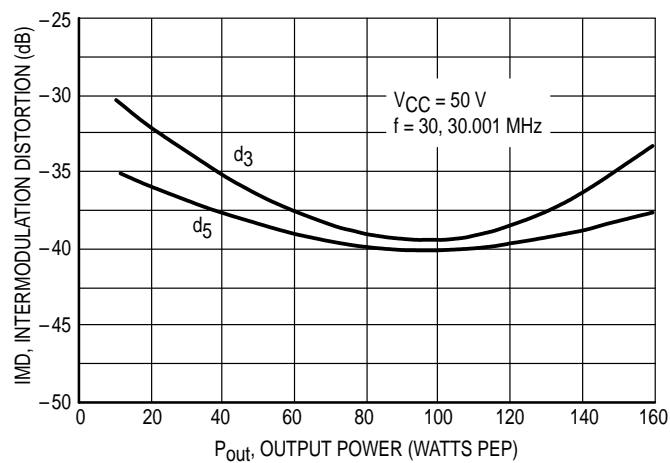

Figure 7. IMD versus  $P_{out}$

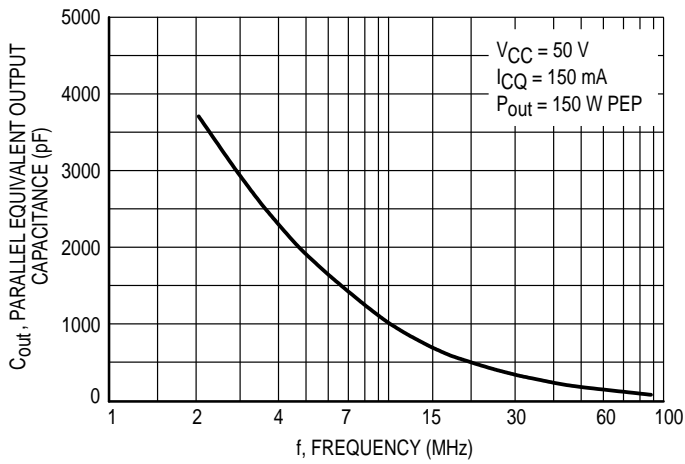

Figure 8. Output Capacitance versus Frequency

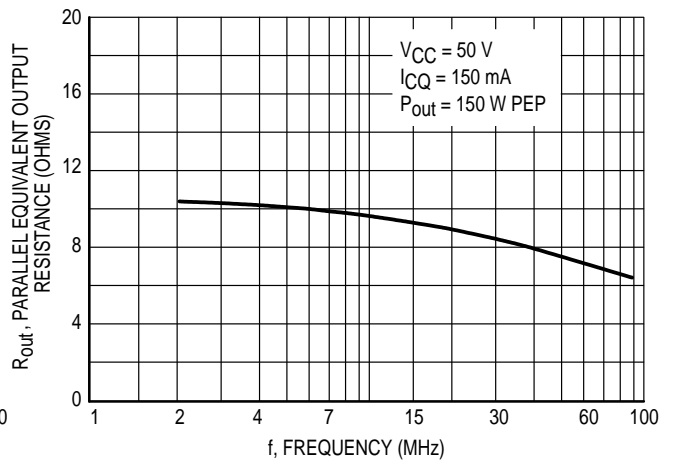

Figure 9. Output Resistance versus Frequency

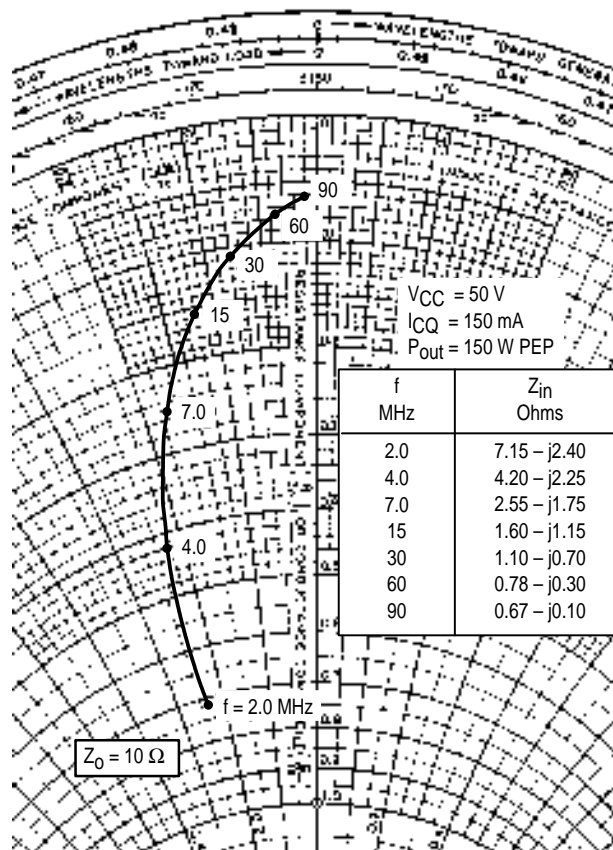
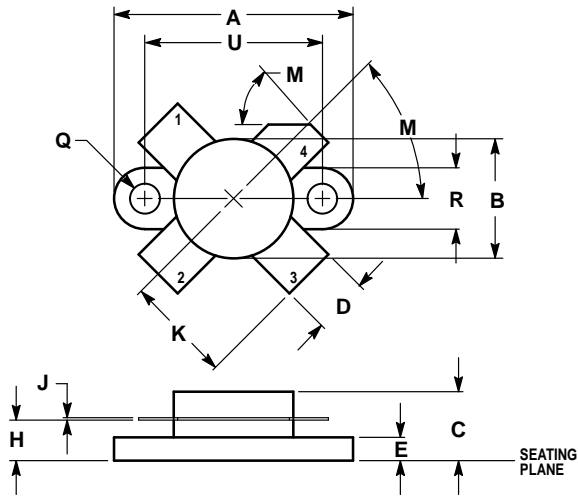

Figure 10. Series Equivalent Impedance

## PACKAGE DIMENSIONS



- NOTES:  
 1. DIMENSIONING AND TOLERANCING PER ANSI Y14.5M, 1982.  
 2. CONTROLLING DIMENSION: INCH.

DIM	INCHES		MILLIMETERS	
	MIN	MAX	MIN	MAX
A	0.960	0.990	24.39	25.14
B	0.465	0.510	11.82	12.95
C	0.229	0.275	5.82	6.98
D	0.216	0.235	5.49	5.96
E	0.084	0.110	2.14	2.79
H	0.144	0.178	3.66	4.52
J	0.003	0.007	0.08	0.17
K	0.435	—	11.05	—
M	45°NOM		45°NOM	
Q	0.115	0.130	2.93	3.30
R	0.246	0.255	6.25	6.47
U	0.720	0.730	18.29	18.54

- STYLE 1:  
 PIN 1. EMITTER  
 2. BASE  
 3. EMITTER  
 4. COLLECTOR

**CASE 211-11  
 ISSUE N**

Motorola reserves the right to make changes without further notice to any products herein. Motorola makes no warranty, representation or guarantee regarding the suitability of its products for any particular purpose, nor does Motorola assume any liability arising out of the application or use of any product or circuit, and specifically disclaims any and all liability, including without limitation consequential or incidental damages. "Typical" parameters can and do vary in different applications. All operating parameters, including "Typicals" must be validated for each customer application by customer's technical experts. Motorola does not convey any license under its patent rights nor the rights of others. Motorola products are not designed, intended, or authorized for use as components in systems intended for surgical implant into the body, or other applications intended to support or sustain life, or for any other application in which the failure of the Motorola product could create a situation where personal injury or death may occur. Should Buyer purchase or use Motorola products for any such unintended or unauthorized application, Buyer shall indemnify and hold Motorola and its officers, employees, subsidiaries, affiliates, and distributors harmless against all claims, costs, damages, and expenses, and reasonable attorney fees arising out of, directly or indirectly, any claim of personal injury or death associated with such unintended or unauthorized use, even if such claim alleges that Motorola was negligent regarding the design or manufacture of the part. Motorola and  are registered trademarks of Motorola, Inc. Motorola, Inc. is an Equal Opportunity/Affirmative Action Employer.

**How to reach us:**

**USA / EUROPE:** Motorola Literature Distribution;  
P.O. Box 20912; Phoenix, Arizona 85036. 1-800-441-2447

**JAPAN:** Nippon Motorola Ltd.; Tatsumi-SPD-JLDC, Toshikatsu Otsuki,  
6F Seibu-Butsuryu-Center, 3-14-2 Tatsumi Koto-Ku, Tokyo 135, Japan. 03-3521-8315

**MFAX:** RMFAX0@email.sps.mot.com - TOUCHTONE (602) 244-6609  
**INTERNET:** <http://Design-NET.com>

**HONG KONG:** Motorola Semiconductors H.K. Ltd.; 8B Tai Ping Industrial Park,  
51 Ting Kok Road, Tai Po, N.T., Hong Kong. 852-26629298



MRF429/D

