

The RF Line

NPN Silicon

RF Power Transistors

... designed primarily for wideband large-signal driver and output amplifier stages in the 30–200 MHz frequency range.

- Guaranteed Performance at 150 MHz, 28 Vdc
Output Power = 30 Watts
Minimum Gain = 10 dB
- 100% Tested for Load Mismatch at All Phase Angles with 30:1 VSWR
- Gold Metallization System for High Reliability Applications

MRF314

**30 W, 30–200 MHz
RF POWER
TRANSISTORS
NPN SILICON**

MAXIMUM RATINGS

Rating	Symbol	Value	Unit
Collector–Emitter Voltage	V _{CEO}	35	Vdc
Collector–Base Voltage	V _{CBO}	65	Vdc
Emitter–Base Voltage	V _{EBO}	4.0	Vdc
Collector Current — Continuous	I _C	3.4	Adc
Total Device Dissipation @ T _C = 25°C (1) Derate above 25°C	P _D	82 0.47	Watts W/°C
Storage Temperature Range	T _{stg}	–65 to +150	°C

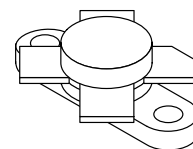

CASE 211–07, STYLE 1

THERMAL CHARACTERISTICS

Characteristic	Symbol	Max	Unit
Thermal Resistance, Junction to Case	R _{θJC}	2.13	°C/W

ELECTRICAL CHARACTERISTICS (T_C = 25°C unless otherwise noted.)

Characteristic	Symbol	Min	Typ	Max	Unit
----------------	--------	-----	-----	-----	------

OFF CHARACTERISTICS

Collector–Emitter Breakdown Voltage (I _C = 30 mAdc, I _B = 0)	V _{(BR)CEO}	35	—	—	Vdc
Collector–Emitter Breakdown Voltage (I _C = 30 mAdc, V _{BE} = 0)	V _{(BR)CES}	65	—	—	Vdc
Collector–Base Breakdown Voltage (I _C = 30 mAdc, I _E = 0)	V _{(BR)CBO}	65	—	—	Vdc
Emitter–Base Breakdown Voltage (I _E = 3.0 mAdc, I _C = 0)	V _{(BR)EBO}	4.0	—	—	Vdc
Collector Cutoff Current (V _{CB} = 30 Vdc, I _E = 0)	I _{CBO}	—	—	3.0	mAdc

ON CHARACTERISTICS

DC Current Gain (I _C = 1.5 Adc, V _{CE} = 5.0 Vdc)	h _{FE}	20	—	80	—
--	-----------------	----	---	----	---

NOTE:

1. These devices are designed for RF operation. The total device dissipation rating applies only when the devices are operated as RF amplifiers.

(continued)

ELECTRICAL CHARACTERISTICS — continued ($T_C = 25^\circ\text{C}$ unless otherwise noted.)

Characteristic	Symbol	Min	Typ	Max	Unit
DYNAMIC CHARACTERISTICS					
Output Capacitance ($V_{CB} = 30\text{ Vdc}$, $I_E = 0$, $f = 1.0\text{ MHz}$)	C_{ob}	—	30	40	pF
FUNCTIONAL TESTS (Figure 1)					
Common-Emitter Amplifier Power Gain ($V_{CC} = 28\text{ Vdc}$, $P_{out} = 30\text{ W}$, $f = 150\text{ MHz}$)	G_{PE}	10	13.5	—	dB
Collector Efficiency ($V_{CC} = 28\text{ Vdc}$, $P_{out} = 30\text{ W}$, $f = 150\text{ MHz}$)	η	50	—	—	%
Load Mismatch ($V_{CC} = 28\text{ Vdc}$, $P_{out} = 30\text{ W}$, $f = 150\text{ MHz}$, VSWR = 30:1 all phase angles)	ψ	No Degradation in Power Output			

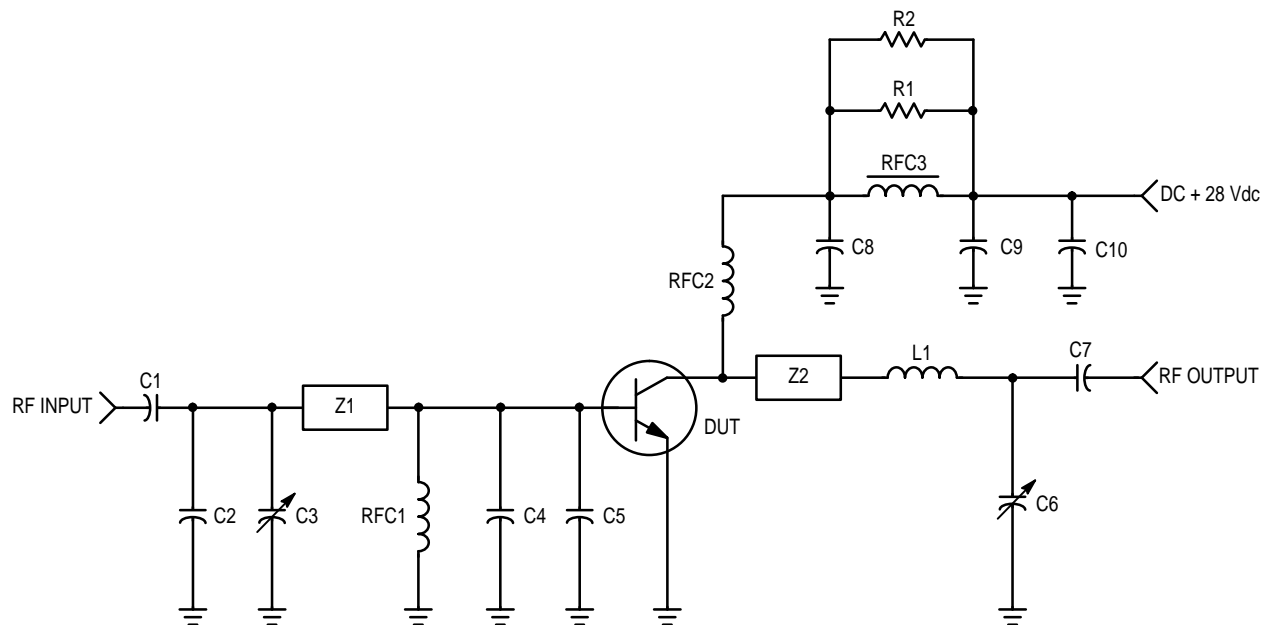

C1, C7 — 18 pF, 100 mil ATC
 C2 — 68 pF, 100 mil ATC
 C3, C6 — Johanson #JMC 5501
 C4 — 270 pF, 100 mil ATC
 C5 — 240 pF, 100 mil ATC
 C8, C9 — 100 pF Underwood
 C10 — 1.0 μF Tantalum
 L1 — 2 Turns, 2.5" #20 Wire, ID = 0.275"

R1, R2 — 10 Ω , 1.0 W
 RFC1 — 15 μH Molded Coil
 RFC2 — 2 Turns, 2.5" #20 Wire, ID = 0.2"
 RFC3 — Ferroxcube VK200-19/4B
 Z1 — Microstrip, 0.168" W x 1.6" L
 Z2 — Microstrip, 0.168" W x 1.2" L
 Board — Glass Teflon $\epsilon_r = 2.55$

Figure 1. 150 MHz Test Circuit

TYPICAL PERFORMANCE CURVES

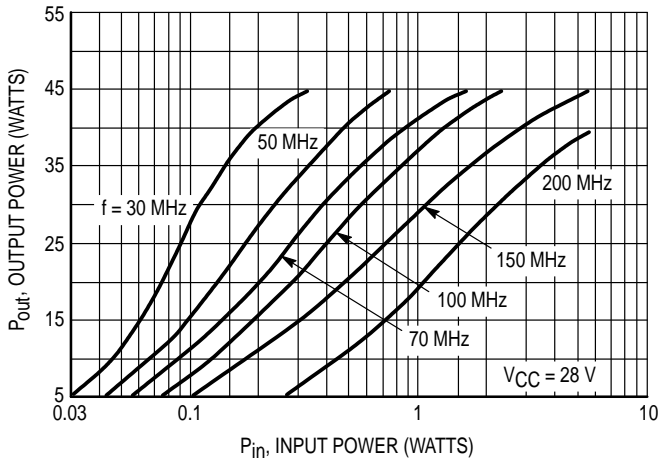

Figure 2. Output Power versus Input Power

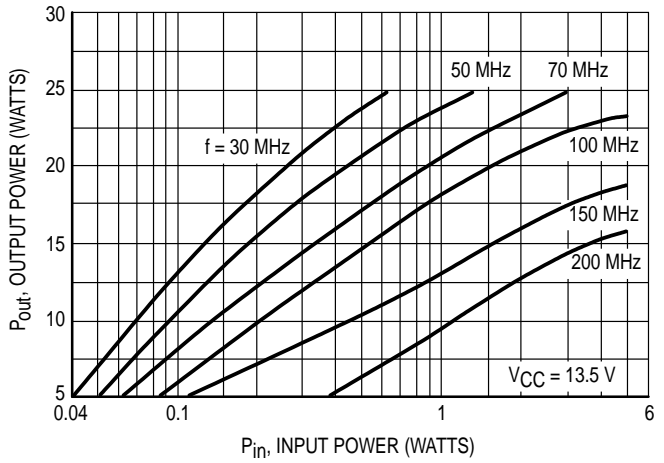

Figure 3. Output Power versus Input Power

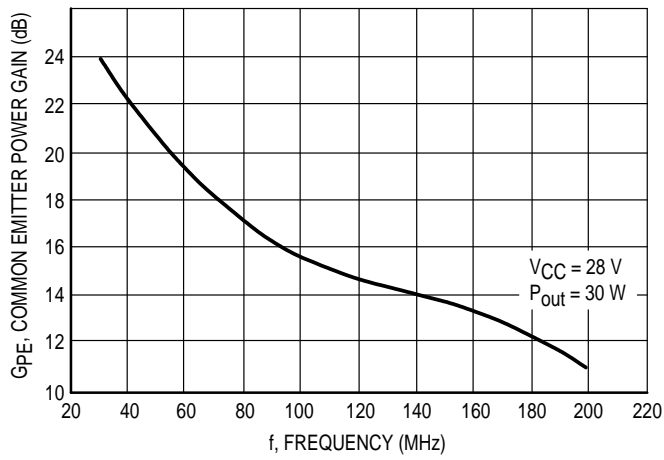

Figure 4. Power Gain versus Frequency

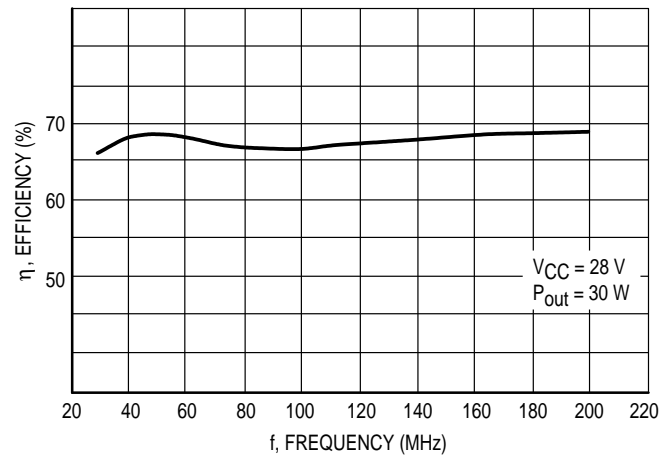
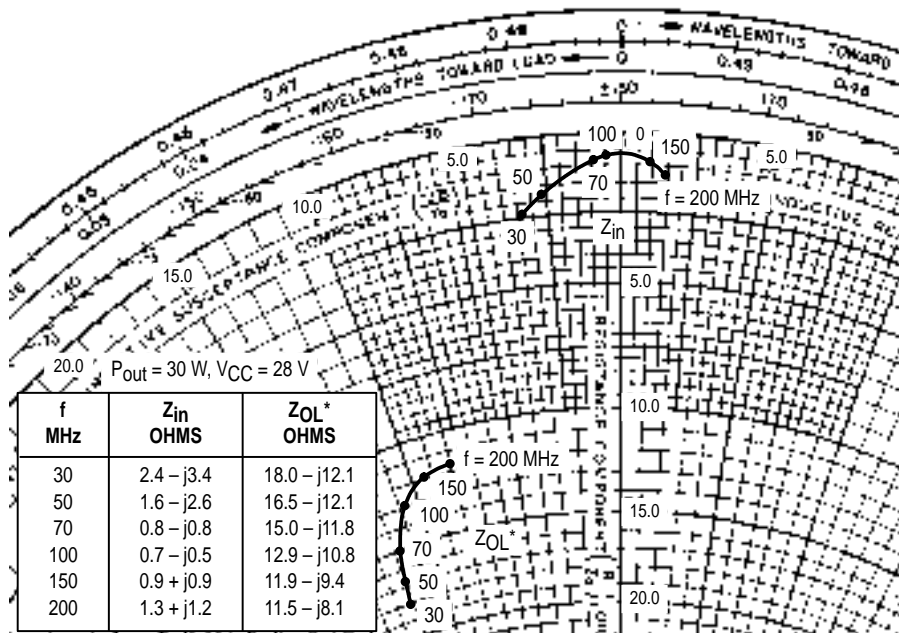

Figure 5. Efficiency versus Frequency



Z_{OL}^* = Conjugate of the optimum load impedance into which the device output operates at a given output power, voltage and frequency.

Figure 6. Series Equivalent Input/Output Impedance

PACKAGE DIMENSIONS

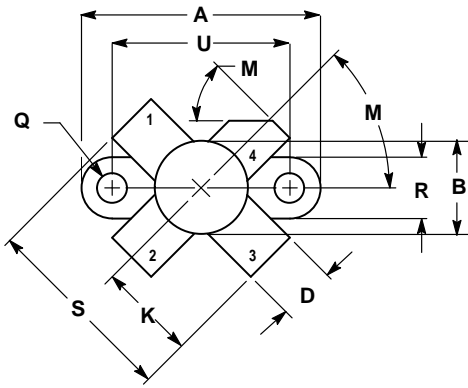

- NOTES:
 1. DIMENSIONING AND TOLERANCING PER ANSI Y14.5M, 1982.
 2. CONTROLLING DIMENSION: INCH.

DIM	INCHES		MILLIMETERS	
	MIN	MAX	MIN	MAX
A	0.960	0.990	24.39	25.14
B	0.370	0.390	9.40	9.90
C	0.229	0.281	5.82	7.13
D	0.215	0.235	5.47	5.96
E	0.085	0.105	2.16	2.66
H	0.150	0.108	3.81	4.57
J	0.004	0.006	0.11	0.15
K	0.395	0.405	10.04	10.28
M	40°	50°	40°	50°
Q	0.113	0.130	2.88	3.30
R	0.245	0.255	6.23	6.47
S	0.790	0.810	20.07	20.57
U	0.720	0.730	18.29	18.54

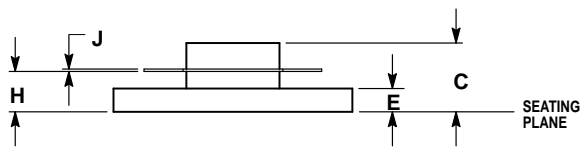

- STYLE 1:
 PIN 1. EMITTER
 2. BASE
 3. EMITTER
 4. COLLECTOR

**CASE 211-07
 ISSUE N**

Motorola reserves the right to make changes without further notice to any products herein. Motorola makes no warranty, representation or guarantee regarding the suitability of its products for any particular purpose, nor does Motorola assume any liability arising out of the application or use of any product or circuit, and specifically disclaims any and all liability, including without limitation consequential or incidental damages. "Typical" parameters can and do vary in different applications. All operating parameters, including "Typicals" must be validated for each customer application by customer's technical experts. Motorola does not convey any license under its patent rights nor the rights of others. Motorola products are not designed, intended, or authorized for use as components in systems intended for surgical implant into the body, or other applications intended to support or sustain life, or for any other application in which the failure of the Motorola product could create a situation where personal injury or death may occur. Should Buyer purchase or use Motorola products for any such unintended or unauthorized application, Buyer shall indemnify and hold Motorola and its officers, employees, subsidiaries, affiliates, and distributors harmless against all claims, costs, damages, and expenses, and reasonable attorney fees arising out of, directly or indirectly, any claim of personal injury or death associated with such unintended or unauthorized use, even if such claim alleges that Motorola was negligent regarding the design or manufacture of the part. Motorola and  are registered trademarks of Motorola, Inc. Motorola, Inc. is an Equal Opportunity/Affirmative Action Employer.

Literature Distribution Centers:

USA: Motorola Literature Distribution; P.O. Box 20912; Phoenix, Arizona 85036.

EUROPE: Motorola Ltd.; European Literature Centre; 88 Tanners Drive, Blakelands, Milton Keynes, MK14 5BP, England.

JAPAN: Nippon Motorola Ltd.; 4-32-1, Nishi-Gotanda, Shinagawa-ku, Tokyo 141, Japan.

ASIA PACIFIC: Motorola Semiconductors H.K. Ltd.; Silicon Harbour Center, No. 2 Dai King Street, Tai Po Industrial Estate, Tai Po, N.T., Hong Kong.



MRF314/D

