

Preliminary Data Sheet

Hybrid Power Module
Integrated Power Stage
for 460 VAC Motor Drives

These modules integrate a 3-phase inverter in a single convenient package. They are designed for 1.0, 2.0 and 3.0 hp motor drive applications. The inverter incorporates advanced insulated gate bipolar transistors (IGBT) matched with free-wheeling diodes to give optimum performance. The top connector pins are designed for easy interfacing to the user's control board.

- Short Circuit Rated 10 μ s @ 125°C
- Pin-to-Baseplate Isolation Exceeds 2500 Vac (rms)
- Compact Package Outline
- Access to Positive and Negative DC Bus
- UL  Recognized

MHPM6B5A120D
MHPM6B10A120D
MHPM6B15A120D

Motorola Preferred Devices

5.0, 10, 15 AMP, 1200 V
HYBRID POWER MODULES

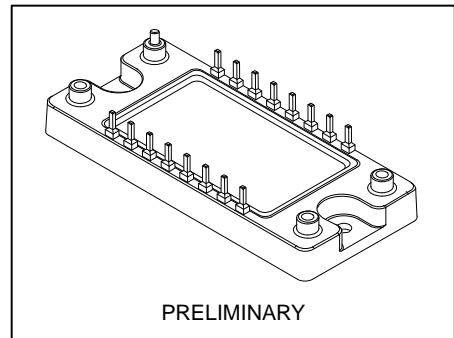

MAXIMUM DEVICE RATINGS ($T_J = 25^\circ\text{C}$ unless otherwise noted)

Rating		Symbol	Value	Unit
IGBT Reverse Voltage		V_{CES}	1200	V
Gate-Emitter Voltage		V_{GES}	± 20	V
Continuous IGBT Collector Current	5A120 10A120 15A120	I_{Cmax}	5.0 10 15	A
Peak Repetitive IGBT Collector Current (1)	5A120 10A120 15A120	$I_{C(pk)}$	10 20 30	A
Continuous Diode Current	5A120 10A120 15A120	I_{Fmax}	5.0 10 15	A
Peak Repetitive Diode Current (1)	5A120 10A120 15A120	$I_{F(pk)}$	10 20 30	A
IGBT Power Dissipation per die ($T_C = 25^\circ\text{C}$)	5A120 10A120 15A120	P_D	43 65 82	W
Diode Power Dissipation per die ($T_C = 25^\circ\text{C}$)	5A120 10A120 15A120	P_D	19 38 38	W
IGBT Power Dissipation per die ($T_C = 95^\circ\text{C}$)	5A120 10A120 15A120	P_D	19 29 36	W
Diode Power Dissipation per die ($T_C = 95^\circ\text{C}$)	5A120 10A120 15A120	P_D	8.3 17 17	W
Junction Temperature Range		T_J	- 40 to +150	$^\circ\text{C}$
Short Circuit Duration ($V_{CC} = 600\text{ V}$, $T_J = 125^\circ\text{C}$)		t_{sc}	10	μsec

(1) 1.0 ms = 1.0% duty cycle

This document contains information on a product under development. Motorola reserves the right to change or discontinue this product without notice.

Preferred devices are Motorola recommended choices for future use and best overall value.

REV 2

MAXIMUM DEVICE RATINGS ($T_J = 25^\circ\text{C}$ unless otherwise noted) — continued

Rating	Symbol	Value	Unit
Isolation Voltage	V_{ISO}	2500	V
Operating Case Temperature Range	T_C	- 40 to +95	$^\circ\text{C}$
Storage Temperature Range	T_{stg}	- 40 to +125	$^\circ\text{C}$
Mounting Torque — Heat Sink Mounting Holes (#8 or M4 screws)	—	12	lb-in

ELECTRICAL CHARACTERISTICS ($T_J = 25^\circ\text{C}$ unless otherwise noted)

Characteristic	Symbol	Min	Typ	Max	Unit
Gate-Emitter Leakage Current ($V_{CE} = 0\text{ V}$, $V_{GE} = \pm 20\text{ V}$)	I_{GES}	—	—	± 20	μA
Collector-Emitter Leakage Current ($V_{CE} = 1200\text{ V}$, $V_{GE} = 0\text{ V}$) $T_J = 125^\circ\text{C}$	I_{CES}	—	6.0 2000	100	μA
Gate-Emitter Threshold Voltage ($V_{CE} = V_{GE}$, $I_C = 1.0\text{ mA}$)	$V_{GE(th)}$	4.0	6.0	8.0	V
Collector-Emitter Breakdown Voltage ($I_C = 10\text{ mA}$, $V_{GE} = 0\text{ V}$)	$V_{(BR)CES}$	1200	—	—	V
Collector-Emitter Saturation Voltage ($I_C = I_{Cmax}$, $V_{GE} = 15\text{ V}$) $T_J = 125^\circ\text{C}$	$V_{CE(SAT)}$	—	2.54 2.33	3.5	V
Diode Forward Voltage ($I_F = I_{Fmax}$, $V_{GE} = 0\text{ V}$) $T_J = 125^\circ\text{C}$	V_F	—	1.67 1.31	2.0	V
Input Capacitance ($V_{CE} = 10\text{ V}$, $V_{GE} = 0\text{ V}$, $f = 1.0\text{ MHz}$)	C_{ies}	—	930	—	pF
			1200	—	
			2800	—	
Input Gate Charge ($V_{CE} = 600\text{ V}$, $I_C = I_{Cmax}$, $V_{GE} = 15\text{ V}$)	Q_T	—	31	—	nC
			65	—	
			100	—	

INDUCTIVE SWITCHING CHARACTERISTICS ($T_J = 25^\circ\text{C}$)

Recommended Gate Resistor					Ω
Turn-On	5A120	$R_{G(on)}$	—	270	—
	10A120		—	220	—
	15A120		—	220	—
Turn-Off		$R_{G(off)}$	—	20	—
Turn-On Delay Time ($V_{CE} = 600\text{ V}$, $I_C = I_{Cmax}$, $V_{GE} = 15\text{ V}$, R_G as specified)		$t_{d(on)}$			ns
	5A120		—	255	—
	10A120		—	350	—
	15A120		—	425	—
Rise Time ($V_{CE} = 600\text{ V}$, $I_C = I_{Cmax}$, $V_{GE} = 15\text{ V}$, R_G as specified)		t_r			ns
	5A120		—	140	—
	10A120		—	250	—
	15A120		—	225	—
Turn-Off Delay Time ($V_{CE} = 600\text{ V}$, $I_C = I_{Cmax}$, $V_{GE} = 15\text{ V}$, R_G as specified)		$t_{d(off)}$	—	170	—
Fall Time ($V_{CE} = 600\text{ V}$, $I_C = I_{Cmax}$, $V_{GE} = 15\text{ V}$, R_G as specified)		t_f	—	290	500
Turn-On Energy ($V_{CE} = 600\text{ V}$, $I_C = I_{Cmax}$, $V_{GE} = 15\text{ V}$, R_G as specified)		$E_{(on)}$			mJ
	5A120		—	0.96	—
	10A120		—	2.8	—
	15A120		—	4.0	—
Turn-Off Energy ($V_{CE} = 600\text{ V}$, $I_C = I_{Cmax}$, $V_{GE} = 15\text{ V}$, R_G as specified)		$E_{(off)}$			mJ
	5A120		—	0.15	1.0
	10A120		—	0.39	2.0
	15A120		—	0.52	2.5
Diode Reverse Recovery Time ($I_F = I_{Fmax}$, $V = 600\text{ V}$, R_G as specified)		t_{rr}			ns
	5A120		—	130	—
	10A120		—	170	—
	15A120		—	165	—

Characteristic		Symbol	Min	Typ	Max	Unit
INDUCTIVE SWITCHING CHARACTERISTICS ($T_J = 25^\circ\text{C}$) – continued						
Peak Reverse Recovery Current ($I_F = I_{Fmax}$, $V = 600\text{ V}$, R_G as specified)	5A120 10A120 15A120	I_{rrm}	— — —	5.0 6.0 9.6	— — —	A
Diode Stored Charge ($I_F = I_{Fmax}$, $V = 600\text{ V}$, R_G as specified)	5A120 10A120 15A120	Q_{rr}	— — —	335 575 860	— — —	nC

INDUCTIVE SWITCHING CHARACTERISTICS ($T_J = 125^\circ\text{C}$)

Characteristic		Symbol	Min	Typ	Max	Unit
Turn-On Delay Time ($V_{CE} = 600\text{ V}$, $I_C = I_{Cmax}$, $V_{GE} = 15\text{ V}$, R_G as specified)	5A120 10A120 15A120	$t_{d(on)}$	— — —	230 315 375	— — —	ns
Rise Time ($V_{CE} = 600\text{ V}$, $I_C = I_{Cmax}$, $V_{GE} = 15\text{ V}$, R_G as specified)	5A120 10A120 15A120	t_r	— — —	130 220 235	— — —	ns
Turn-Off Delay Time ($V_{CE} = 600\text{ V}$, $I_C = I_{Cmax}$, $V_{GE} = 15\text{ V}$, R_G as specified)		$t_{d(off)}$	—	176	—	ns
Fall Time ($V_{CE} = 600\text{ V}$, $I_C = I_{Cmax}$, $V_{GE} = 15\text{ V}$, R_G as specified)		t_f	—	676	—	ns
Turn-On Energy ($V_{CE} = 600\text{ V}$, $I_C = I_{Cmax}$, $V_{GE} = 15\text{ V}$, R_G as specified)	5A120 10A120 15A120	$E_{(on)}$	— — —	1.3 3.9 5.5	— — —	mJ
Turn-Off Energy ($V_{CE} = 600\text{ V}$, $I_C = I_{Cmax}$, $V_{GE} = 15\text{ V}$, R_G as specified)	5A120 10A120 15A120	$E_{(off)}$	— — —	0.711 1.290 1.939	— — —	mJ
Diode Reverse Recovery Time ($I_F = I_{Fmax}$, $V = 600\text{ V}$, R_G as specified)	5A120 10A120 15A120	t_{rr}	— — —	190 375 310	— — —	ns
Peak Reverse Recovery Current ($I_F = I_{Fmax}$, $V = 600\text{ V}$, R_G as specified)	5A120 10A120 15A120	I_{rrm}	— — —	8.4 10 15	— — —	A
Diode Stored Charge ($I_F = I_{Fmax}$, $V = 600\text{ V}$, R_G as specified)	5A120 10A120 15A120	Q_{rr}	— — —	825 2100 2500	— — —	nC

THERMAL CHARACTERISTICS (Each Die)

Thermal Resistance — IGBT	5A120 10A120 15A120	$R_{\theta JC}$	— — —	2.30 1.54 1.21	2.88 1.92 1.52	$^\circ\text{C/W}$
Thermal Resistance — Free-Wheeling Diode	5A120 10A120 15A120	$R_{\theta JC}$	— — —	5.28 2.61 2.61	6.60 3.26 3.26	$^\circ\text{C/W}$

TYPICAL CHARACTERISTICS

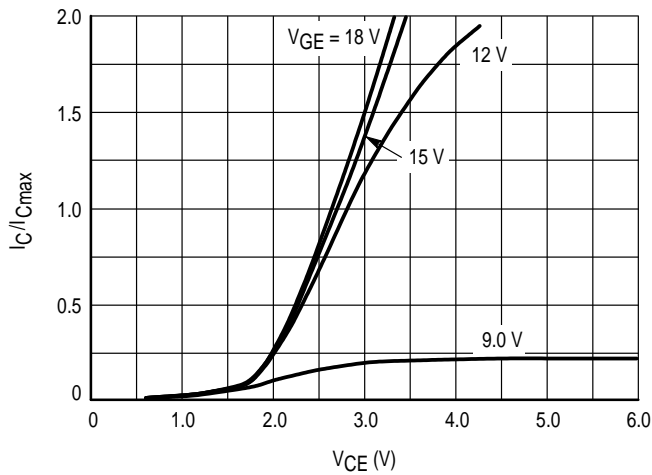

Figure 1. Normalized I_C versus V_{CE} , $T_J = 25^\circ\text{C}$

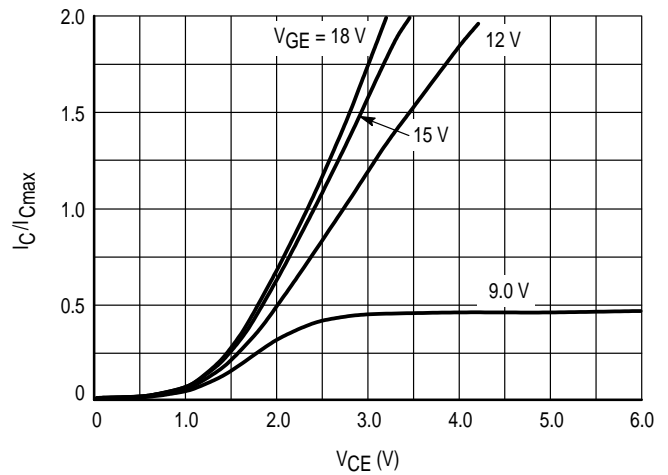

Figure 2. Normalized I_C versus V_{CE} , $T_J = 125^\circ\text{C}$

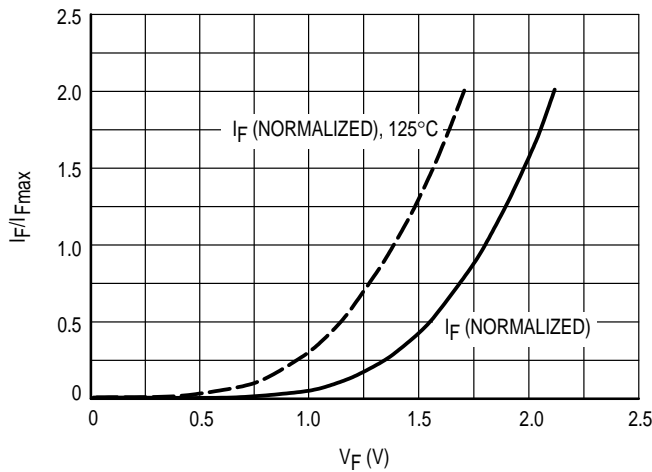

Figure 3. I_F versus V_F

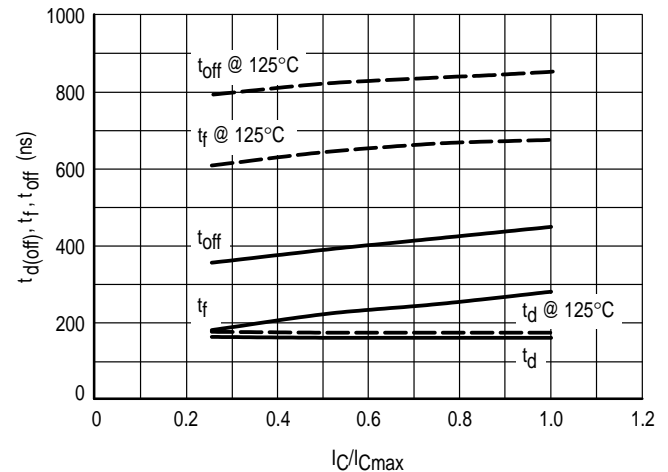

Figure 4. $t_{d(off)}$, t_f , t_{off} versus Normalized I_C

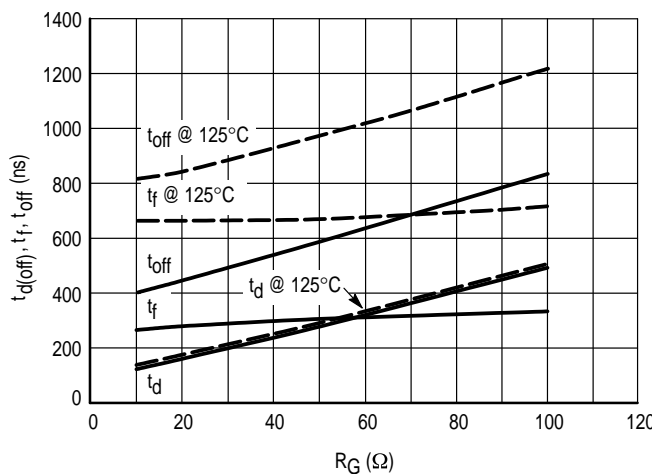

Figure 5. $t_{d(off)}$, t_f , t_{off} versus R_G

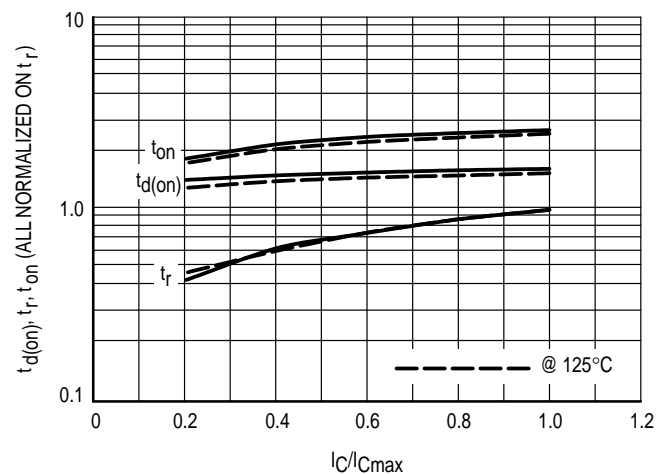

Figure 6. $t_{d(on)}$, t_r , t_{on} versus I_C

TYPICAL CHARACTERISTICS

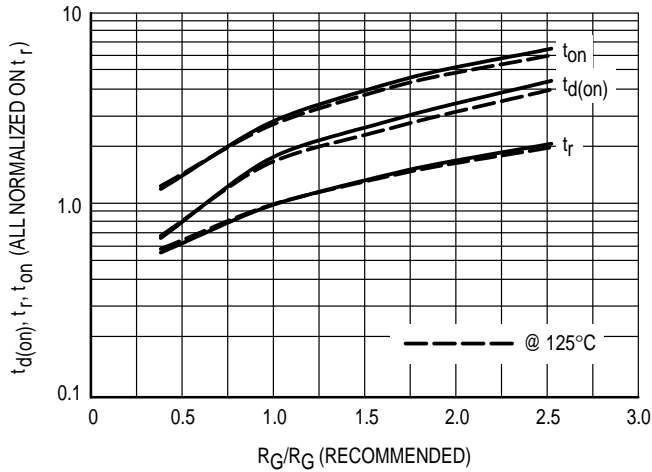

Figure 7. $t_{d(on)}$, t_r , t_{on} versus Normalized R_G

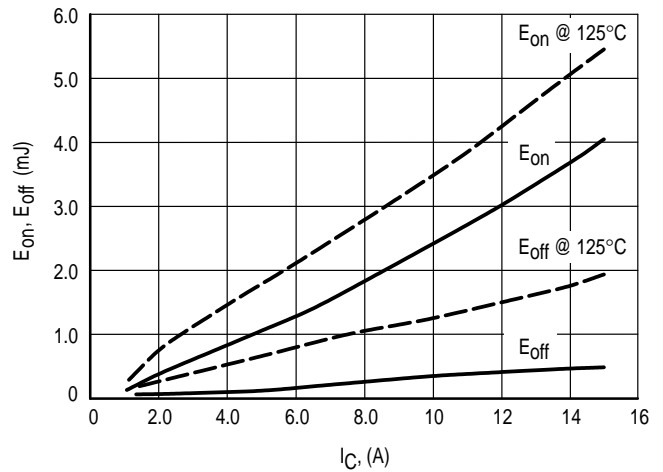

Figure 8. E_{on} , E_{off} versus I_C

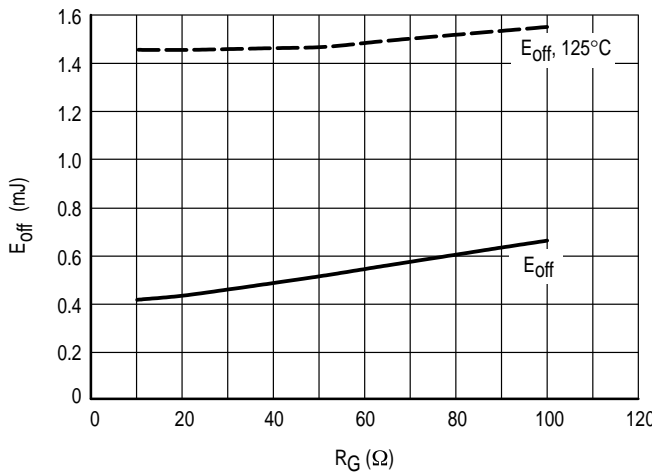

Figure 9. E_{off} versus $R_{G(off)}$ at Rated I_C

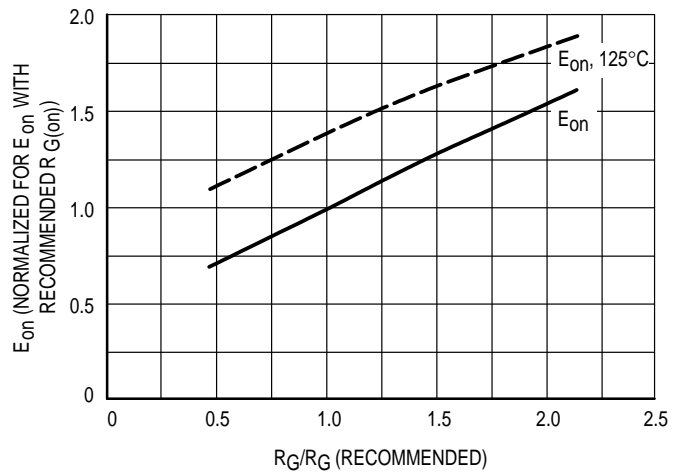

Figure 10. Normalized E_{on} versus Normalized $R_{G(on)}$

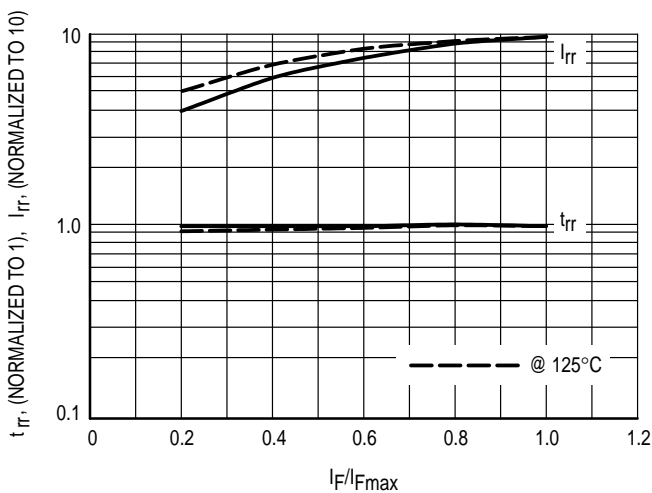

Figure 11. t_{rr} , I_{rr} versus Normalized I_F

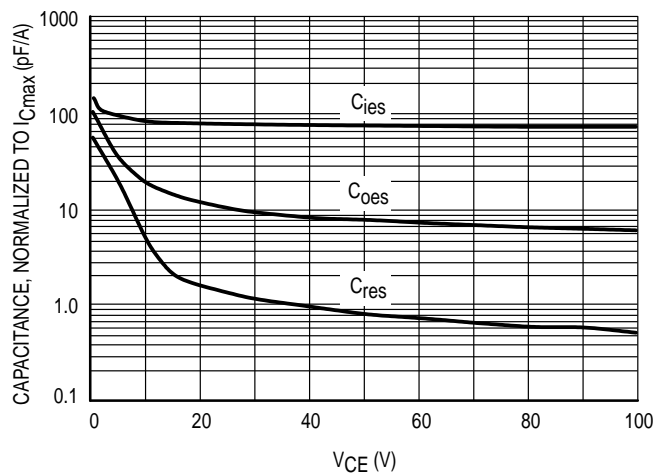

Figure 12. Capacitance Variation

TYPICAL CHARACTERISTICS

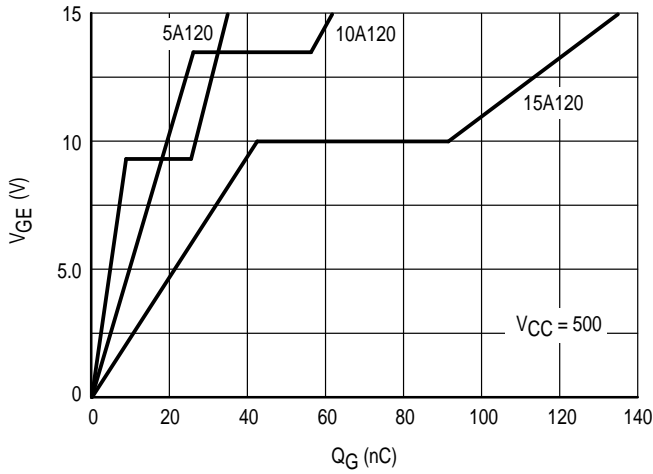

Figure 13. V_{GE} versus Q_G

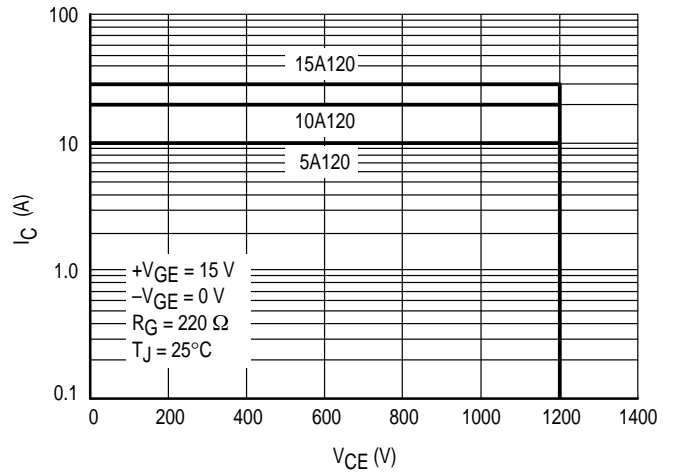

Figure 14. Reverse Biased Safe Operating Area

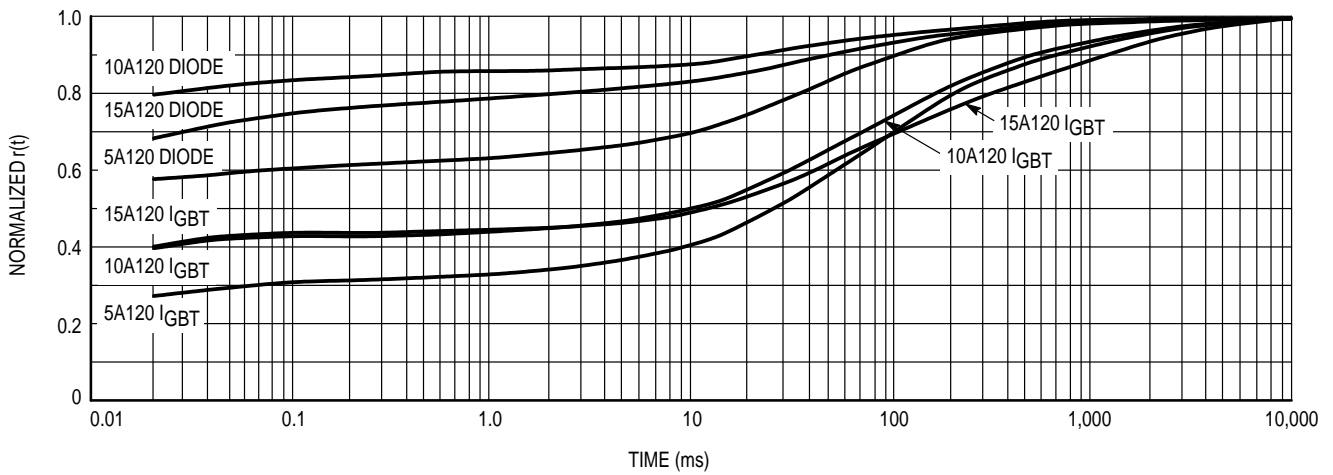

Figure 15. Normalized $r(t)$

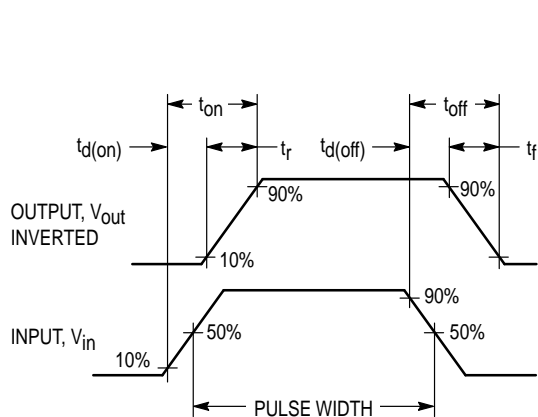

Figure 16. Switching Waveforms

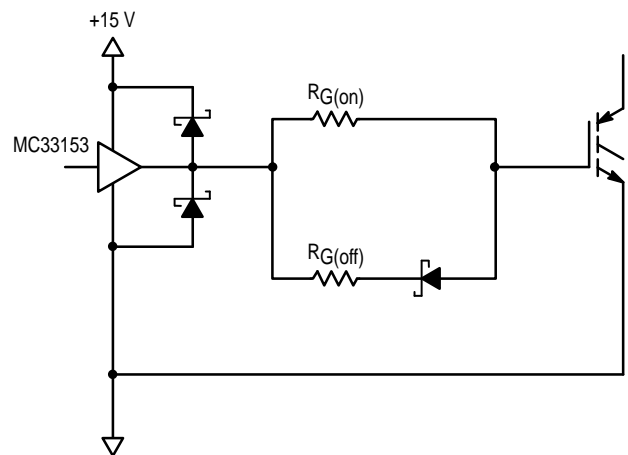

Figure 17. Typical Gate Drive Circuit

APPLICATION INFORMATION

These modules are designed to be used as the power stage of a three-phase AC induction motor drive. They may be used for up to 230 VAC applications. Switching frequencies up to 10 kHz have been considered in the design.

Gate resistance recommendations have been listed. Separate turn-on and turn-off resistors are listed, to be used in a circuit resembling Figure 17. All switching characteristics are given based on following these recommendations, but appropriate graphs are shown for operation with different gate resistance. In order to equalize across the three different module ratings, a normalization process was used. Actual typical values are listed in the second section of this specification sheet, "Electrical Specifications," but many of the graphs are given in normalized units.

The first three graphs, the DC characteristics, are normalized for current. The devices are designed to operate the same at rated maximum current (10 and 20 A). The curves extend to I_{Cpk} , the maximum allowable instantaneous current.

The next graph, turn-off times versus current, is again normalized to the rated maximum current. The following graph, turn-off times versus $R_{G(off)}$, is intentionally not normalized, as all three modules behave similarly during turn-off.

Turn-on times have been normalized. Again, the graph showing variation due to current has been normalized for rated maximum current. The graph showing variation due to gate resistance normalizes against the recommended $R_{G(on)}$ for each module. In addition, the times are normalized to t_r at the appropriate temperature. For example, $t_d(on)$ for a 10 A module operating at 125°C at 4.0 A can be found by multiplying the typical t_r for a 10 A module at 125°C (220 ns) by the value shown on the graph at a normalized current of 0.4 (1.4) to get 308 ns. The most salient features demonstrated by these graphs are the general trends: rise time is a

larger fraction of total turn-on time at 125°C, and in general, larger gate resistance results in slower switching.

Graphs of switching energies follow a similar structure. The first of these graphs, showing variation due to current, is not normalized, as any of these devices operating within its limits follows the same trend. E_{off} does not need to be normalized to show variation with $R_{G(off)}$, as all three are specified with the same nominal resistance. E_{on} , however, has been appropriately normalized. Gate resistance has been normalized to the specified $R_{G(on)}$. In order to show the effect of elevated temperature, all energies were normalized to E_{on} at 25°C using the recommended $R_{G(on)}$.

Reverse recovery characteristics are also normalized. I_f is normalized to rated maximum current. I_{rrm} is normalized so that at maximum current at either 25°C or 125°C, the graph indicates "10", while t_{rr} is normalized to be "1" at maximum current at either temperature.

Capacitance values are normalized for I_{Cmax} . Due to poor scaling, gate charge and thermal characteristics are shown separately for each module.

Many issues must be considered when doing PCB layout. Figure 19 shows the footprint of a module, allowing for reasonable tolerances. A polarizing post is provided near pin 1 to ensure that the module is properly inserted during final assembly. When laying out traces, two issues are of primary importance: current carrying capacity and voltage clearance. Many techniques may be used to maximize both, including using traces on both sides of the PCB to double total copper thickness, providing cut-outs in high-current traces near high-voltage pins, and even removing portions of the board to increase "over-the-surface" creepage distance. Some additional advantage may be gained by potting the entire board assembly in a good dielectric. Consult appropriate regulatory standards, such as UL 840, for more details on high-voltage creepage and clearance.

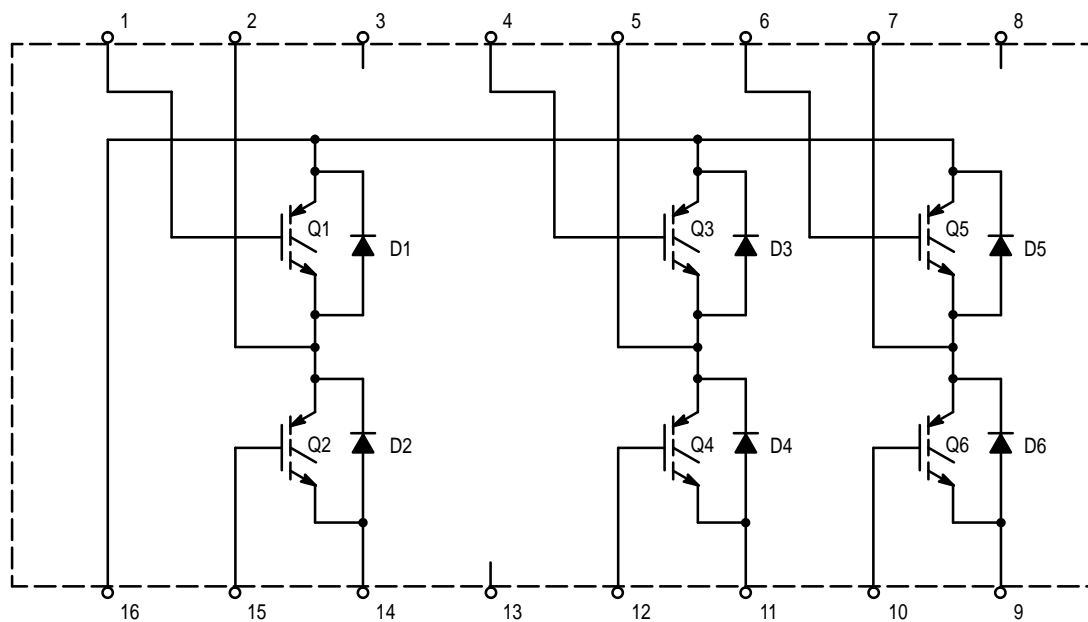

Figure 18. Schematic of Internal Circuit, Showing Package Pin-Out

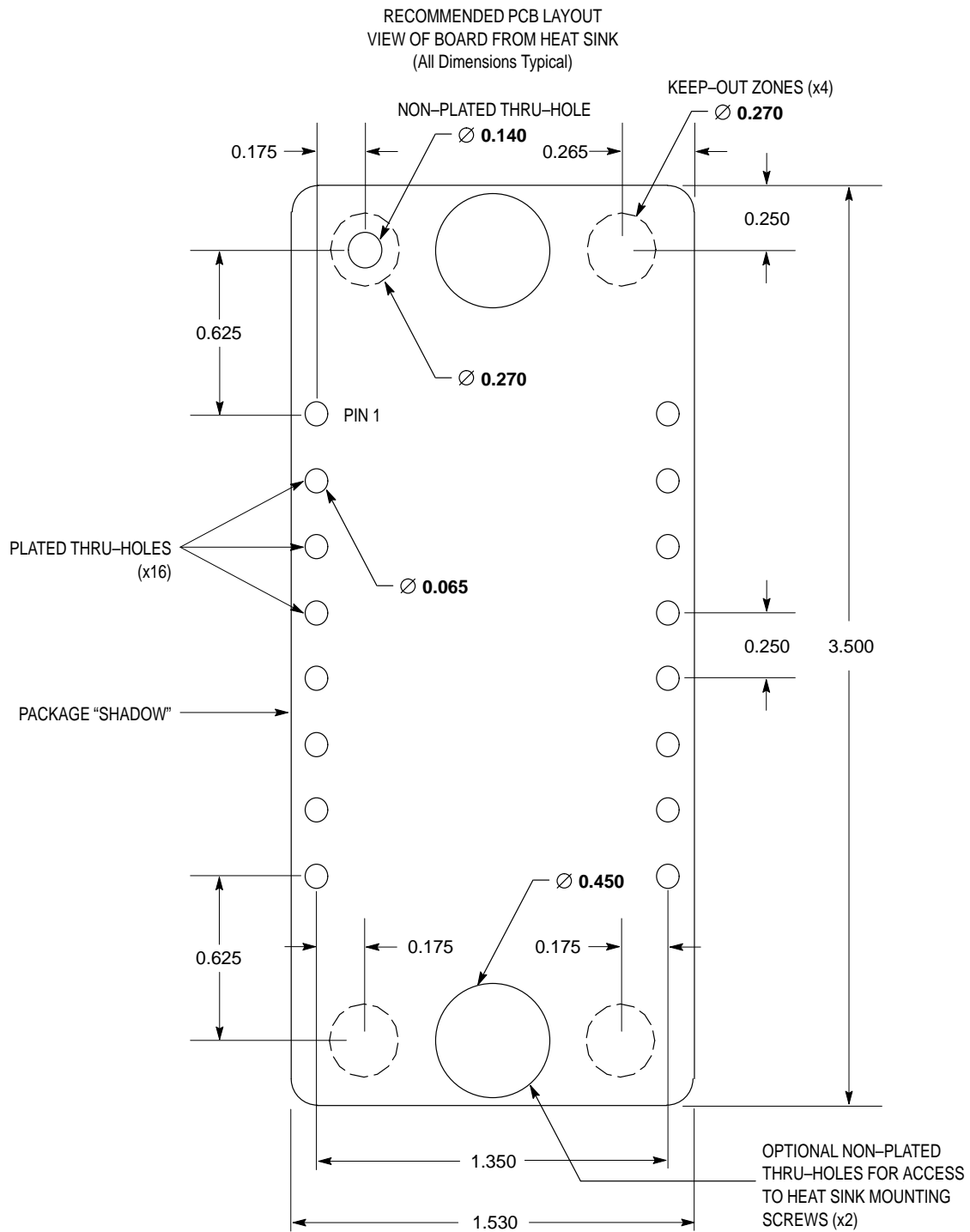
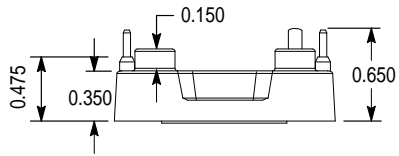
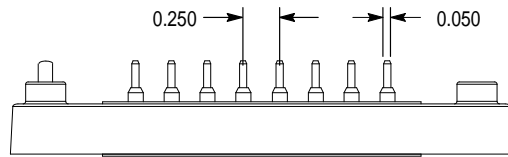
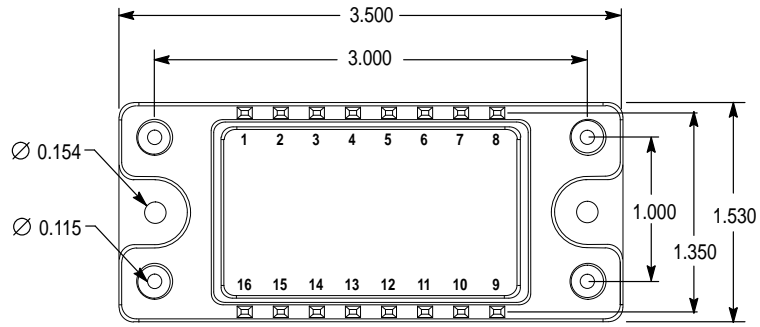

Figure 19. Package Footprint

NOTES:

1. Package is symmetrical, except for a polarizing plastic post near pin 1, indicated by a non-plated thru-hole in the footprint.
2. Dimension of plated thru-holes indicates net size after plating.
3. Access holes for mounting screws may or may not be necessary depending on assembly plan for finished product.

PACKAGE DIMENSIONS



PRELIMINARY

Motorola reserves the right to make changes without further notice to any products herein. Motorola makes no warranty, representation or guarantee regarding the suitability of its products for any particular purpose, nor does Motorola assume any liability arising out of the application or use of any product or circuit, and specifically disclaims any and all liability, including without limitation consequential or incidental damages. "Typical" parameters which may be provided in Motorola data sheets and/or specifications can and do vary in different applications and actual performance may vary over time. All operating parameters, including "Typicals" must be validated for each customer application by customer's technical experts. Motorola does not convey any license under its patent rights nor the rights of others. Motorola products are not designed, intended, or authorized for use as components in systems intended for surgical implant into the body, or other applications intended to support or sustain life, or for any other application in which the failure of the Motorola product could create a situation where personal injury or death may occur. Should Buyer purchase or use Motorola products for any such unintended or unauthorized application, Buyer shall indemnify and hold Motorola and its officers, employees, subsidiaries, affiliates, and distributors harmless against all claims, costs, damages, and expenses, and reasonable attorney fees arising out of, directly or indirectly, any claim of personal injury or death associated with such unintended or unauthorized use, even if such claim alleges that Motorola was negligent regarding the design or manufacture of the part. Motorola and  are registered trademarks of Motorola, Inc. Motorola, Inc. is an Equal Opportunity/Affirmative Action Employer.

Mfax is a trademark of Motorola, Inc.

How to reach us:

USA/EUROPE/Locations Not Listed: Motorola Literature Distribution;
P.O. Box 5405, Denver, Colorado 80217. 303-675-2140 or 1-800-441-2447

JAPAN: Nippon Motorola Ltd.: SPD, Strategic Planning Office, 4-32-1,
Nishi-Gotanda, Shinagawa-ku, Tokyo 141, Japan. 81-3-5487-8488

Mfax™: RMFAX0@email.sps.mot.com – TOUCHTONE 602-244-6609
– US & Canada ONLY 1-800-774-1848

ASIA/PACIFIC: Motorola Semiconductors H.K. Ltd.; 8B Tai Ping Industrial Park,
51 Ting Kok Road, Tai Po, N.T., Hong Kong. 852-26629298

INTERNET: <http://motorola.com/sps>



MHPM6B5A120D/D