

April 1995

Features

- 12A, 400V and 500V
- $V_{CE(ON)}$: 2.5V Max.
- T_{FALL} : 1 μ s, 0.5 μ s
- Low On-State Voltage
- Fast Switching Speeds
- High Input Impedance
- Anti-Parallel Diode

Applications

- Power Supplies
- Motor Drives
- Protective Circuits

Description

The HGTH12N40C1D, HGTH12N40E1D, HGTH12N50C1D, and HGTH12N50E1D are n-channel enhancement-mode insulated gate bipolar transistors (IGBTs) designed for high voltage, low on-dissipation applications such as switching regulators and motor drivers. They feature a discrete anti-parallel diode that shunts current around the IGBT in the reverse direction without introducing carriers into the depletion region. These types can be operated directly from low power integrated circuits.

PACKAGING AVAILABILITY

PART NUMBER	PACKAGE	BRAND
HGTH12N40C1D	TO-218AC	G12N40C1D
HGTH12N40E1D	TO-218AC	G12N40E1D
HGTH12N50C1D	TO-218AC	G12N50C1D
HGTH12N50E1D	TO-218AC	G12N50E1D

NOTE: When ordering, use the entire part number

Package

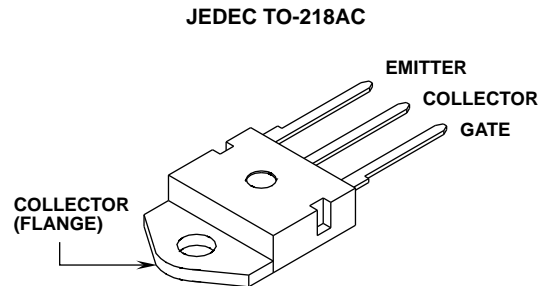

Terminal Diagram

N-CHANNEL ENHANCEMENT MODE

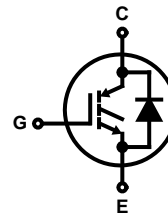

Absolute Maximum Ratings $T_C = +25^\circ\text{C}$, Unless Otherwise Specified

	HGTH12N40C1D HGTH12N40E1D	HGTH12N50C1D HGTH12N50E1D	UNITS
Collector-Emitter Voltage V_{CES}	400	500	V
Collector-Gate Voltage $R_{GE} = 1M\Omega$ V_{CGR}	400	500	V
Gate-Emitter Voltage V_{GE}	± 20	± 20	V
Collector Current Continuous I_C	12	12	A
Collector Current Pulsed I_{CM}	17.5	17.5	A
Power Dissipation Total at $T_C = +25^\circ\text{C}$ P_D	75	75	W
Power Dissipation Derating $T_C > +25^\circ\text{C}$	0.6	0.6	W/ $^\circ\text{C}$
Operating and Storage Junction Temperature Range T_J, T_{STG}	-55 to +150	-55 to +150	$^\circ\text{C}$

HARRIS SEMICONDUCTOR IGBT PRODUCT IS COVERED BY ONE OR MORE OF THE FOLLOWING U.S. PATENTS:

4,364,073	4,417,385	4,430,792	4,443,931	4,466,176	4,516,143	4,532,534	4,567,641
4,587,713	4,598,461	4,605,948	4,618,872	4,620,211	4,631,564	4,639,754	4,639,762
4,641,162	4,644,637	4,682,195	4,684,413	4,694,313	4,717,679	4,743,952	4,783,690
4,794,432	4,801,986	4,803,533	4,809,045	4,809,047	4,810,665	4,823,176	4,837,606
4,860,080	4,883,767	4,888,627	4,890,143	4,901,127	4,904,609	4,933,740	4,963,951
4,969,027							

Specifications HGTH12N40C1D, HGTH12N40E1D, HGTH12N50C1D, HGTH12N50E1D

Electrical Specifications $T_C = +25^\circ\text{C}$, Unless Otherwise Specified

PARAMETERS	SYMBOL	TEST CONDITIONS	LIMITS				UNITS	
			HGTH12N40C1D, HGTH12N40E1D		HGTH12N50C1D, HGTH12N50E1D			
			MIN	MAX	MIN	MAX		
Collector-Emitter Breakdown Voltage	V_{CES}	$I_C = 1\text{mA}, V_{GE} = 0$	400	-	500	-	V	
Gate Threshold Voltage	$V_{GE(TH)}$	$V_{GE} = V_{CE}, I_C = 1\text{mA}$	2.0	4.5	2.0	4.5	V	
Zero Gate Voltage Collector Current	I_{CES}	$V_{CE} = 400\text{V}, T_C = +25^\circ\text{C}$	-	250	-	-	μA	
		$V_{CE} = 500\text{V}, T_C = +25^\circ\text{C}$	-	-	-	250	μA	
		$V_{CE} = 400\text{V}, T_C = +125^\circ\text{C}$	-	1000	-	-	μA	
		$V_{CE} = 500\text{V}, T_C = +125^\circ\text{C}$	-	-	-	1000	μA	
Gate-Emitter Leakage Current	I_{GES}	$V_{GE} = \pm 20\text{V}, V_{CE} = 0$	-	100	-	100	nA	
Collector-Emitter On Voltage	$V_{CE(ON)}$	$I_C = 10\text{A}, V_{GE} = 10\text{V}$	-	2.5	-	2.5	V	
		$I_C = 17.5\text{A}, V_{GE} = 20\text{V}$	-	3.2	-	3.2	V	
Gate-Emitter Plateau Voltage	V_{GEP}	$I_C = 5\text{A}, V_{CE} = 10\text{V}$	-	6 (Typ)	-	6 (Typ)	V	
On-State Gate Charge	$Q_{G(ON)}$	$I_C = 5\text{A}, V_{CE} = 10\text{V}$	-	19 (Typ)	-	19 (Typ)	nC	
Turn-On Delay Time	$t_{D(ON)I}$	$I_C = 10\text{A}, V_{CE(CLP)} = 300\text{V},$ $L = 50\mu\text{H}, T_J = +100^\circ\text{C},$ $V_{GE} = 10\text{V}, R_G = 50\Omega$ (Note 9)	-	50	-	50	ns	
Rise Time	t_{RI}		-	50	-	50	ns	
Turn-Off Delay Time	$t_{D(OFF)I}$		-	400	-	400	ns	
Fall Time	t_{FI}		40E1D, 50E1D	680 (Typ)	1000	680 (Typ)	1000	ns
			40C1D, 50C1D	400 (Typ)	500	400 (Typ)	500	ns
Turn-Off Energy Loss per Cycle (Off Switching Dissipation = $W_{OFF} \times$ Frequency)	W_{OFF}	40E1D, 50E1D	1810 (Typ)				μJ	
		40C1D, 50C1D	1070 (Typ)				μJ	
Thermal Resistance Junction-to-Case	$R_{\theta JC}$		-	1.67	-	1.67	$^\circ\text{C/W}$	
Diode Forward Voltage	V_{EC}	$I_{EC} = 10\text{A}$	-	2	-	2	V	
Diode Reverse Recovery Time	t_{RR}	$I_{EC} = 10\text{A}, dl_{EC}/dt =$ $100\text{A}/\mu\text{s}$	-	100	-	100	ns	

Typical Performance Curves

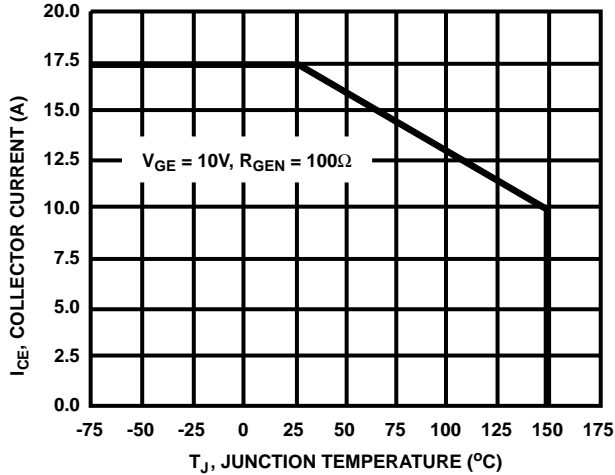

FIGURE 1. MAX. SWITCHING CURRENT LEVEL. $R_G = 50\Omega$, $V_{GE} = 0V$ ARE THE MIN. ALLOWABLE VALUES

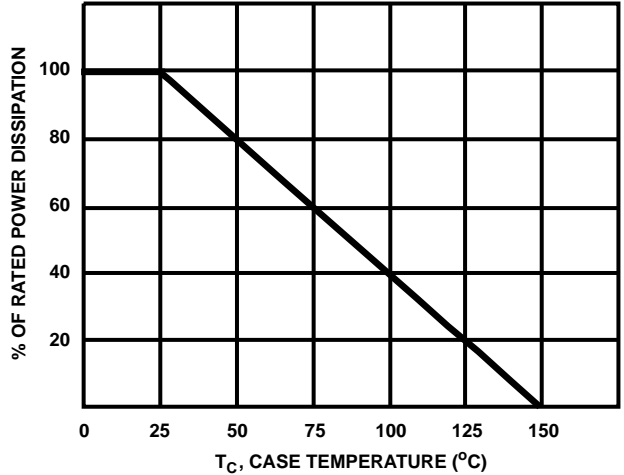

FIGURE 2. POWER DISSIPATION vs TEMPERATURE DERATING CURVE

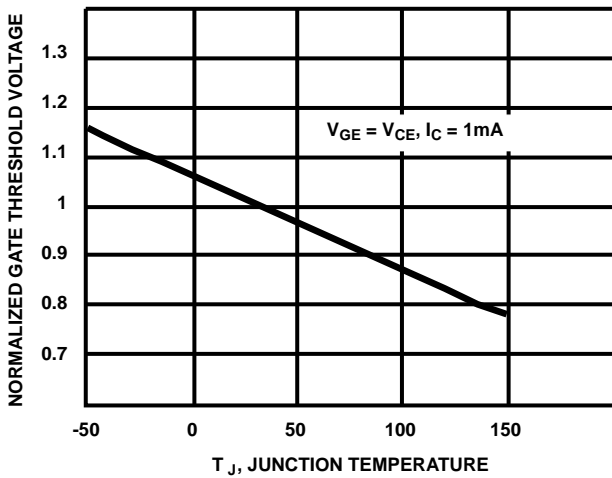

FIGURE 3. TYPICAL NORMALIZED GATE THRESHOLD VOLTAGE vs JUNCTION TEMPERATURE

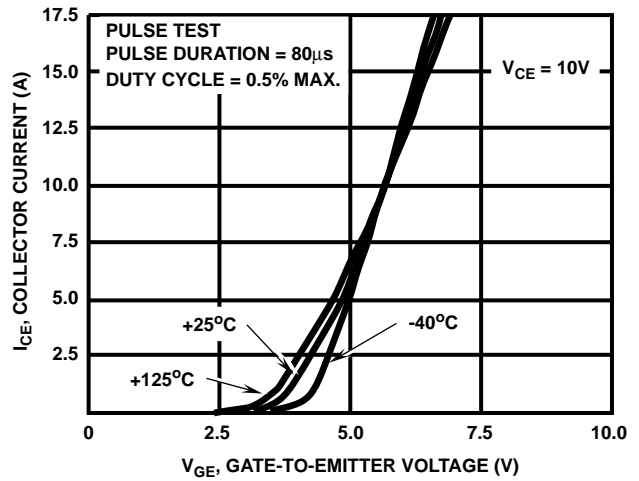

FIGURE 4. TYPICAL TRANSFER CHARACTERISTICS

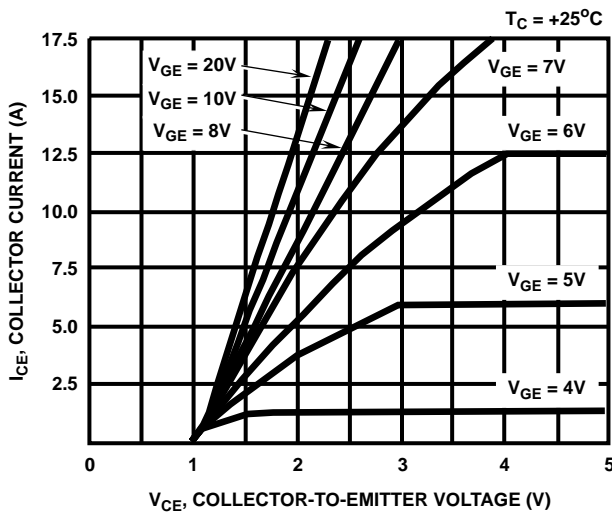

FIGURE 5. TYPICAL SATURATION CHARACTERISTICS

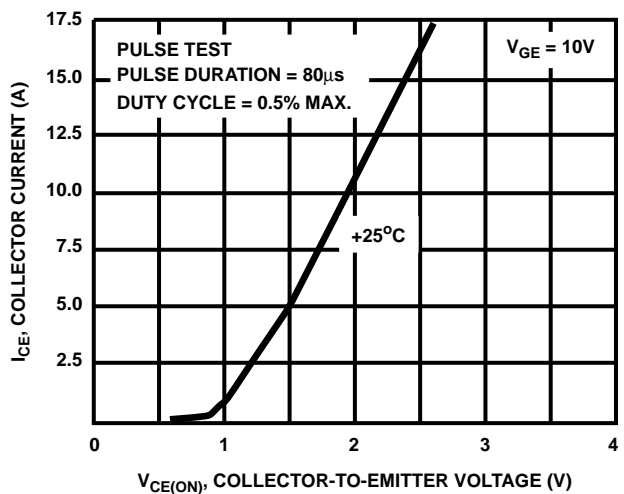

FIGURE 6. TYPICAL COLLECTOR-TO-EMITTER ON VOLTAGE vs COLLECTOR CURRENT

Typical Performance Curves (Continued)

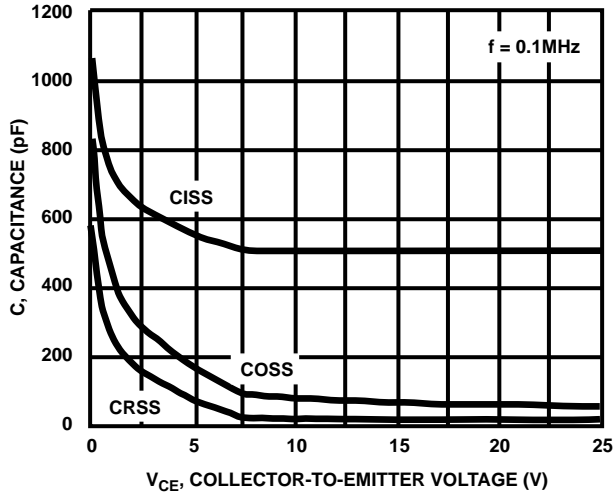

FIGURE 7. CAPACITANCE vs COLLECTOR-TO-EMITTER VOLTAGE

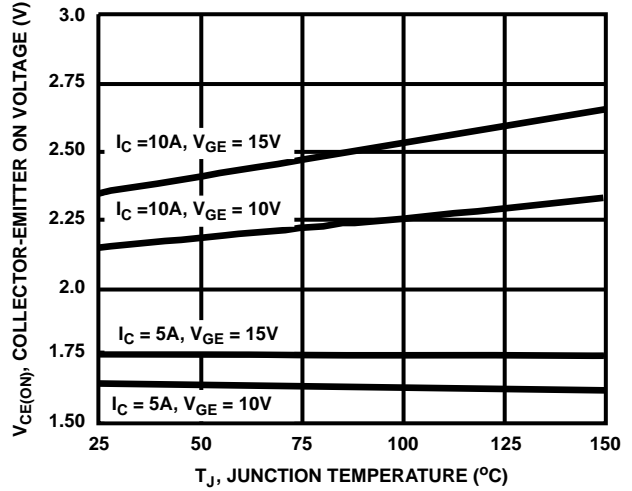

FIGURE 8. TYPICAL $V_{CE(ON)}$ vs TEMPERATURE

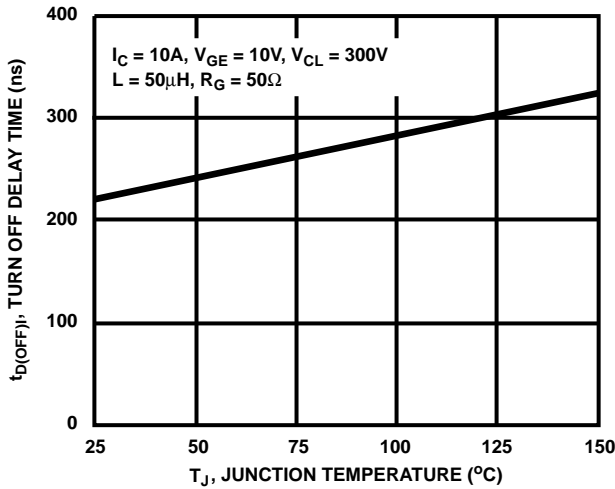

FIGURE 9. TYPICAL TURN-OFF DELAY TIME

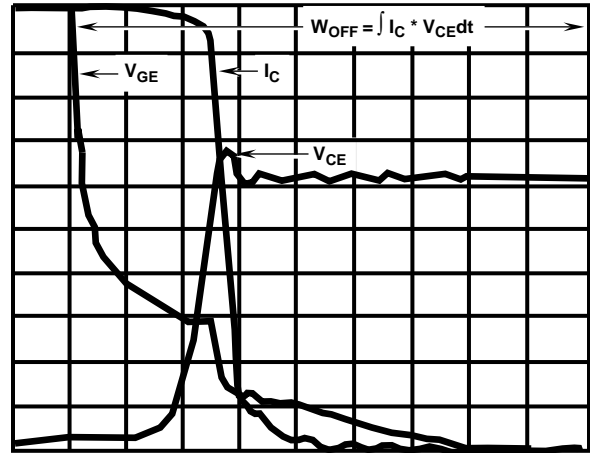

FIGURE 10. TYPICAL INDUCTIVE SWITCHING WAVEFORMS

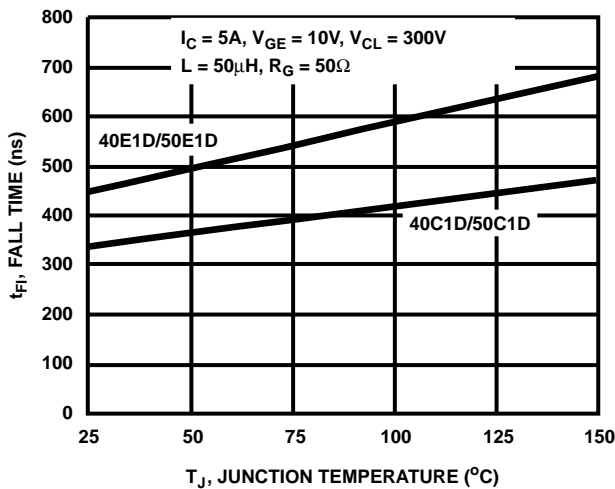

FIGURE 11. TYPICAL FALL TIME ($I_C = 5A$)

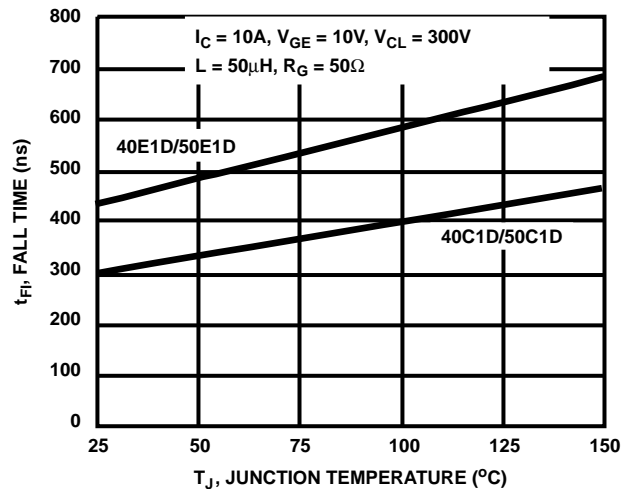

FIGURE 12. TYPICAL FALL TIME ($I_C = 10A$)

Typical Performance Curves (Continued)

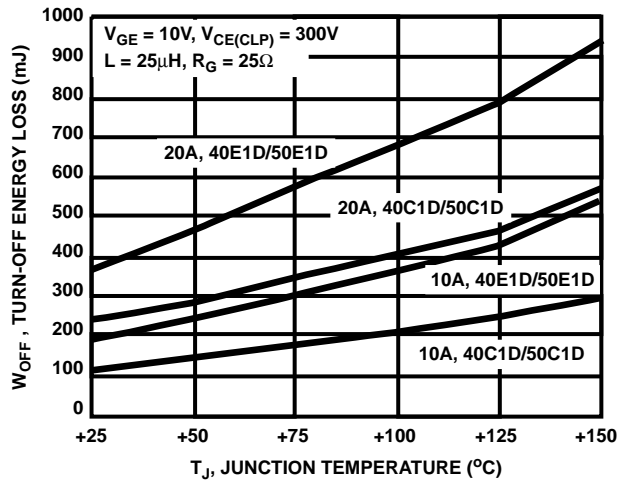

FIGURE 13. TYPICAL CLAMPED INDUCTIVE TURN-OFF SWITCHING LOSS/CYCLE

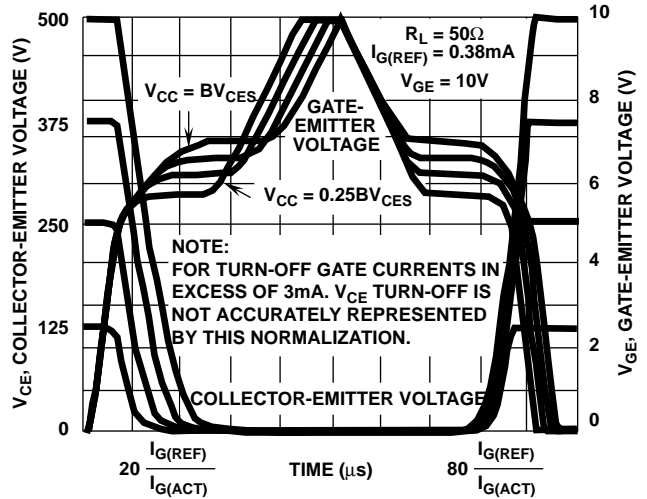

FIGURE 14. NORMALIZED SWITCHING WAVEFORMS AT CONSTANT GATE CURRENT (REFER TO APPLICATION NOTES AN7254 AND AN7260)

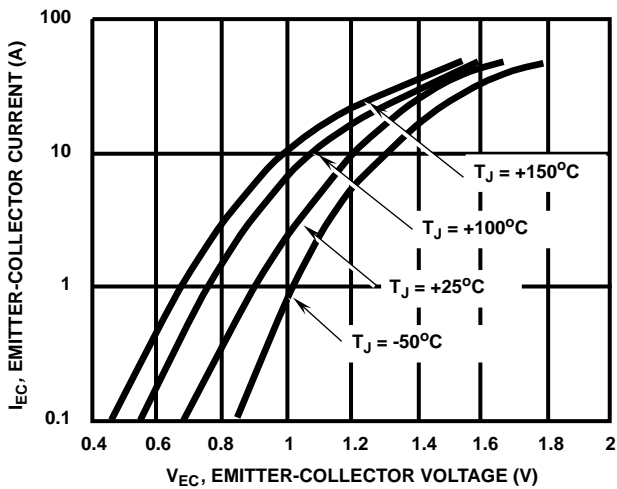

FIGURE 15. TYPICAL DIODE EMITTER-TO-COLLECTOR VOLTAGE vs CURRENT

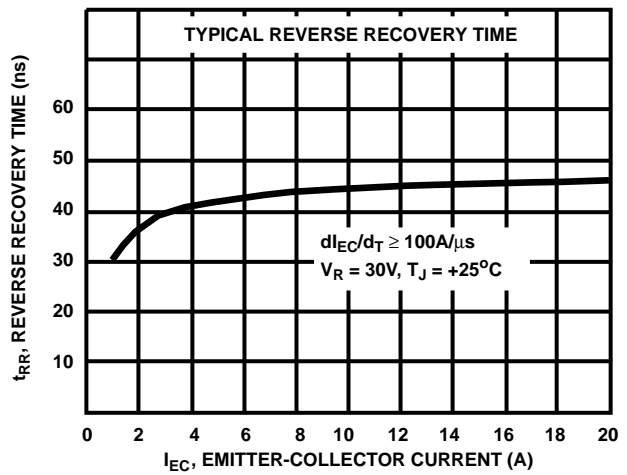

FIGURE 16. TYPICAL DIODE REVERSE RECOVERY TIME

Test Circuit

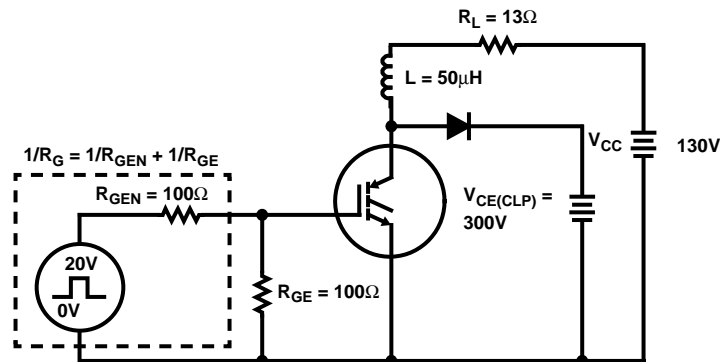

FIGURE 17. INDUCTIVE SWITCHING TEST CIRCUIT