

August 1994

## Dual Long-Tailed Pair Transistor Array

### Features

- High Gain-Bandwidth Product ( $f_T$ ) . . . . . 10GHz
- High Power Gain-Bandwidth Product . . . . . 5GHz
- High Current Gain ( $h_{FE}$ ) . . . . . 70
- Noise Figure (Transistor) . . . . . 3.5dB
- Low Collector Leakage Current . . . . . <0.01nA
- Excellent  $h_{FE}$  and  $V_{BE}$  Matching
- Pin-to-Pin to UPA102G

### Applications

- Single Balanced Mixers
- Wide Band Amplification Stages
- Differential Amplifiers
- Multipliers
- Automatic Gain Control Circuits
- Frequency Doublers, Triplers
- Oscillators
- Constant Current Sources
- Wireless Communication Systems
- Radio and Satellite Communications
- Fiber Optic Signal Processing
- High Performance Instrumentation

### Description

The HFA3102 is an all NPN transistor array configured as dual differential amplifiers with tail transistors. Based on Harris bonded wafer UHF-1 SOI process, this array achieves very high  $f_T$  (10GHz) while maintaining excellent  $h_{FE}$  and  $V_{BE}$  matching characteristics over temperature. Collector leakage currents are maintained to under 0.01nA.

### Ordering Information

PART NUMBER	PRODUCT DESCRIPTION
HFA3102Y	Die
HFA3102B	14 Lead Plastic SOIC (N)
HFA3102B96	14 Lead Plastic SOIC (N) - Tape and Reel

### Pinout/Functional Diagram

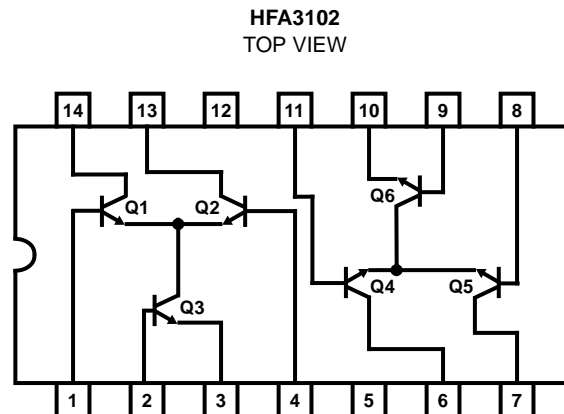

# Specifications HFA3102

## Absolute Maximum Ratings

$V_{CE0}$ Collector to Emitter Voltage	8.0V
$V_{CBO}$ Collector to Base Voltage	12.0V
$V_{EBO}$ Emitter to Base Voltage	12.0V
$I_C$ Collector Current	30mA
$T_{STG}$ , Storage Temperature Range	-65°C to +150°C
Operating Temperature Range	-40°C to +85°C
$T_J$ , Junction Temperature (Die)	+175°C
$T_J$ , Junction Temperature (Plastic Package)	+150°C
Lead Temperature (Soldering 10s)	+300°C

(Lead Tips Only)

## Thermal Information

Thermal Resistance	$\theta_{JA}$
Plastic SOIC Package	125°C/W
Maximum Package Power Dissipation at +75°C	
Any One Transistor	0.25W
Plastic SOIC Package	0.6W
Derating Factor Above +75°C	
Plastic SOIC Package	8mW/°C

**CAUTION:** Stresses above those listed in "Absolute Maximum Ratings" may cause permanent damage to the device. This is a stress only rating and operation of the device at these or any other conditions above those indicated in the operational sections of this specification is not implied.

## Electrical Specifications at +25°C

SYMBOLS	PARAMETER	TEST CONDITIONS	TEST LEVEL	ALL GRADES			UNITS
				MIN	TYP	MAX	
$V_{(BR)CBO}$	Collector-to-Base Breakdown Voltage (Q <sub>1</sub> , Q <sub>2</sub> , Q <sub>4</sub> , and Q <sub>5</sub> )	$I_C = 100\mu A, I_E = 0$	A	12	18	-	V
$V_{(BR)CEO}$	Collector-to-Emitter Breakdown Voltage (Q <sub>1</sub> thru Q <sub>6</sub> )	$I_C = 100\mu A, I_B = 0$	A	8	12	-	V
$V_{(BR)EBO}$	Emitter-to-Base Breakdown Voltage (Q <sub>3</sub> and Q <sub>6</sub> )	$I_E = 50\mu A, I_C = 0$	A	5.5	6	-	V
$I_{CBO}$	Collector Cutoff Current (Q <sub>1</sub> , Q <sub>2</sub> , Q <sub>4</sub> , and Q <sub>5</sub> )	$V_{CB} = 5V, I_E = 0$	A	-	0.1	10	nA
$I_{EBO}$	Emitter Cutoff Current (Q <sub>3</sub> and Q <sub>6</sub> )	$V_{EB} = 1V, I_C = 0$	A	-	-	100	nA
$h_{FE}$	DC Current Gain (Q <sub>1</sub> thru Q <sub>6</sub> )	$I_C = 10mA, V_{CE} = 3V$	A	40	70	-	-
$C_{CB}$	Collector-to-Base Capacitance	$V_{CB} = 5V, f = 1MHz$	B	-	300	-	fF
$C_{EB}$	Emitter-to-Base Capacitance	$V_{EB} = 0, f = 1MHz$	B	-	200	-	fF
$f_T$	Current Gain-Bandwidth Product	$I_C = 10mA, V_{CE} = 5V$	C	-	10	-	GHz
$f_{MAX}$	Power Gain-Bandwidth Product	$I_C = 10mA, V_{CE} = 5V$	C	-	5	-	GHz
$G_{NFMIN}$	Available Gain at Minimum Noise Figure	$I_C = 3mA, V_{CE} = 3V$ $f = 0.5GHz$	C	-	-	-	-
			-	-	17.5	-	dB
			-	-	12.4	-	-
$NF_{MIN}$	Minimum Noise Figure	$I_C = 3mA, V_{CE} = 3V$ $f = 0.5GHz$	C	-	-	-	-
			-	-	1.8	-	dB
			-	-	2.1	-	-
$NF_{50\Omega}$	50Ω Noise Figure	$I_C = 3mA, V_{CE} = 3V$ $f = 0.5GHz$	C	-	-	-	-
			-	-	3.3	-	dB
			-	-	3.5	-	-
$h_{FE1}/h_{FE2}$	DC Current Gain Matching (Q <sub>1</sub> and Q <sub>2</sub> , Q <sub>4</sub> and Q <sub>5</sub> )	$V_{CE} = 3V, I_C = 10mA$	A	0.9	1.0	1.1	-
$V_{OS}$	Input Offset Voltage (Q <sub>1</sub> and Q <sub>2</sub> ), (Q <sub>4</sub> and Q <sub>5</sub> )	$I_C = 10mA, V_{CE} = 3V$	A	-	1.5	5	mV
$I_{OS}$	Input Offset Current (Q <sub>1</sub> and Q <sub>2</sub> ), (Q <sub>4</sub> and Q <sub>5</sub> )	$I_C = 10mA, V_{CE} = 3V$	A	-	5	25	μA
$dV_{OS}/dT$	Input Offset Voltage TC (Q <sub>1</sub> and Q <sub>2</sub> , Q <sub>4</sub> and Q <sub>5</sub> )	$I_C = 10mA, V_{CE} = 3V$	C	-	0.5	-	μV/°C
$I_{TRENCH-LEAKAGE}$	Collector-to-Collector Leakage (Pin 6, 7, 13, and 14)	$\Delta V_{TEST} = 5V$	B	-	0.01	-	nA

Test Level: A. Production Tested    B. Guaranteed Limit or Typical Based on Characterization    C. Design Typical for Information Only

Performance Curves

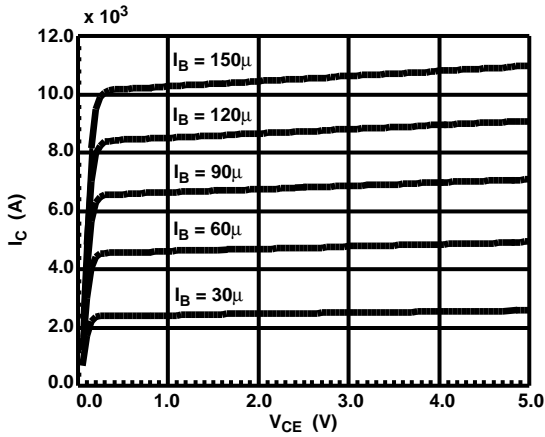

FIGURE 1.  $I_C$  vs  $V_{CE}$

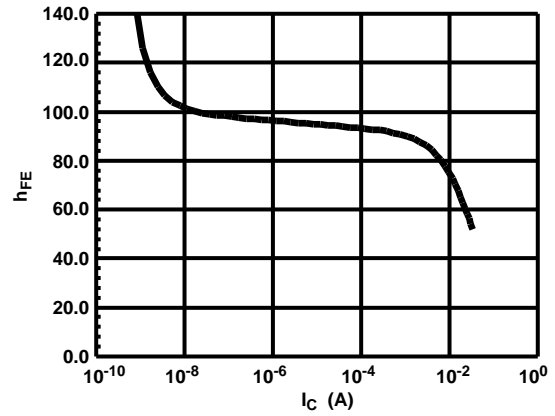

FIGURE 2.  $h_{FE}$  vs  $I_C$

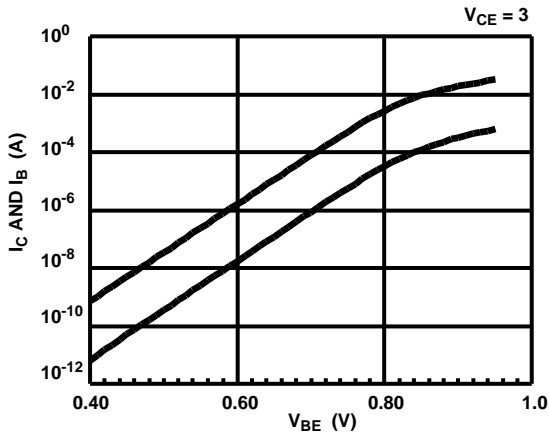

FIGURE 3. GUMMEL PLOT

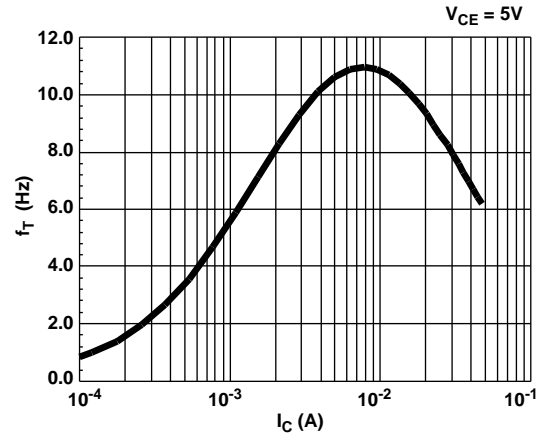

FIGURE 4.  $f_T$  vs  $I_C$

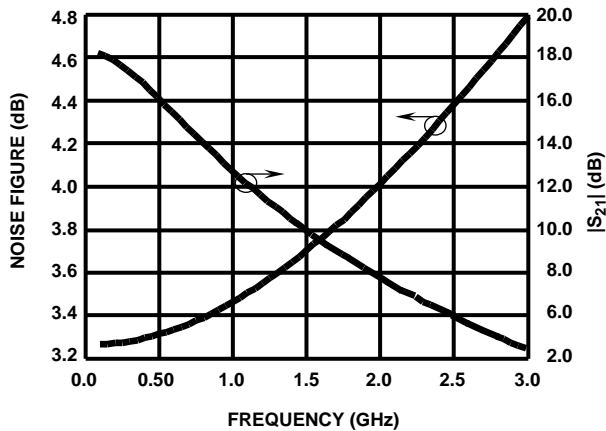

FIGURE 5. GAIN AND NOISE FIGURE vs FREQUENCY

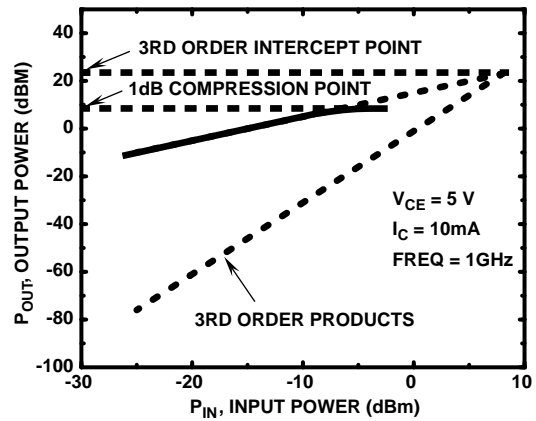

FIGURE 6.  $P_{1dB}$  AND 3RD ORDER INTERCEPT

**PSPICE Model for a Single Transistor**

+ ( IS= 1.840E-16 XTI= 3.000E+00 EG= 1.110E+00 VAF= 7.200E+01  
+ VAR= 4.500E+00 BF= 1.036E+02 ISE= 1.686E-19 NE= 1.400E+00  
+ IKF= 5.400E-02 XTB= 0.000E+00 BR= 1.000E+01 ISC= 1.605E-14  
+ NC= 1.800E+00 IKR= 5.400E-02 RC= 1.140E+01 CJC= 3.980E-13  
+ MJC= 2.400E-01 VJC= 9.700E-01 FC= 5.000E-01 CJE= 2.400E-13  
+ MJE= 5.100E-01 VJE= 8.690E-01 TR= 4.000E-09 TF= 10.51E-12  
+ ITF= 3.500E-02 XTF= 2.300E+00 VTF= 3.500E+00 PTF= 0.000E+00  
+ XCJC= 9.000E-01 CJS= 1.689E-13 VJS= 9.982E-01 MJS= 0.000E+00  
+ RE= 1.848E+00 RB= 5.007E+01 RBM= 1.974E+00 KF= 0.000E+00  
+ AF= 1.000E+00)

# HFA3102

## Common Emitter S-Parameters

$V_{CE} = 5V$  and  $I_C = 5mA$

FREQ. (Hz)	S11	PHASE(S11)	S12	PHASE(S12)	S21	PHASE(S21)	S22	PHASE(S22)
1.0E+08	0.833079	-11.7873	1.418901E-02	78.8805	11.0722	168.576	0.976833	-11.0509
2.0E+08	0.791776	-22.8290	2.695740E-02	68.6355	10.5177	157.897	0.930993	-21.3586
3.0E+08	0.734911	-32.6450	3.750029E-02	59.5861	9.75379	148.443	0.868128	-30.4451
4.0E+08	0.672811	-41.0871	4.572138E-02	51.9018	8.91866	140.361	0.799886	-38.1641
5.0E+08	0.612401	-48.2370	5.194147E-02	45.5043	8.10511	133.569	0.734033	-44.5998
6.0E+08	0.557126	-54.2780	5.659943E-02	40.2112	7.35944	127.882	0.674392	-49.9370
7.0E+08	0.508133	-59.4102	6.009507E-02	35.8226	6.69712	123.102	0.622181	-54.3777
8.0E+08	0.465361	-63.8123	6.274213E-02	32.1594	6.11750	119.047	0.577269	-58.1022
9.0E+08	0.428238	-67.6313	6.477134E-02	29.0743	5.61303	115.571	0.538952	-61.2587
1.0E+09	0.396034	-70.9834	6.634791E-02	26.4506	5.17405	112.556	0.506365	-63.9647
1.1E+09	0.368032	-73.9591	6.758932E-02	24.1974	4.79104	109.913	0.478663	-66.3116
1.2E+09	0.343589	-76.6285	6.857937E-02	22.2441	4.45546	107.570	0.455091	-68.3702
1.3E+09	0.322155	-79.0462	6.937837E-02	20.5358	4.15997	105.472	0.435008	-70.1958
1.4E+09	0.303268	-81.2548	7.003020E-02	19.0293	3.89845	103.576	0.417872	-71.8314
1.5E+09	0.286542	-83.2880	7.056718E-02	17.6908	3.66577	101.849	0.403238	-73.3108
1.6E+09	0.271660	-85.1723	7.101343E-02	16.4930	3.45770	100.262	0.390735	-74.6609
1.7E+09	0.258359	-86.9292	7.138717E-02	15.4143	3.27074	98.7956	0.380056	-75.9030
1.8E+09	0.246420	-88.5759	7.170231E-02	14.4370	3.10197	97.4307	0.370947	-77.0544
1.9E+09	0.235659	-90.1265	7.196964E-02	13.5469	2.94897	96.1533	0.363195	-78.1288
2.0E+09	0.225923	-91.5925	7.219757E-02	12.7319	2.80969	94.9515	0.356623	-79.1377
2.1E+09	0.217085	-92.9836	7.239274E-02	11.9824	2.68243	93.8156	0.351081	-80.0903
2.2E+09	0.209034	-94.3076	7.256046E-02	11.2901	2.56573	92.7373	0.346442	-80.9942
2.3E+09	0.201678	-95.5713	7.270498E-02	10.6480	2.45837	91.7097	0.342599	-81.8557
2.4E+09	0.194939	-96.7803	7.282977E-02	10.0503	2.35928	90.7271	0.339458	-82.6802
2.5E+09	0.188747	-97.9395	7.293764E-02	9.49212	2.26756	89.7844	0.336942	-83.4719
2.6E+09	0.183044	-99.0530	7.303093E-02	8.96908	2.18243	88.8775	0.334982	-84.2347
2.7E+09	0.177780	-100.124	7.311157E-02	8.47753	2.10322	88.0026	0.333518	-84.9716
2.8E+09	0.172909	-101.156	7.318117E-02	8.01430	2.02934	87.1565	0.332499	-85.6853
2.9E+09	0.168394	-102.152	7.324107E-02	7.57661	1.96027	86.3366	0.331879	-86.3781
3.0E+09	0.164200	-103.114	7.329243E-02	7.16204	1.89556	85.5404	0.331620	-87.0518

$V_{CE} = 5V$  and  $I_C = 10mA$

FREQ. (Hz)	S11	PHASE(S11)	S12	PHASE(S12)	S21	PHASE(S21)	S22	PHASE(S22)
1.0E+08	0.728106	-16.4319	1.273920E-02	75.4177	15.1273	165.227	0.959692	-14.2688
2.0E+08	0.670836	-31.2669	2.342300E-02	62.8941	13.9061	152.045	0.886232	-26.9507
3.0E+08	0.600268	-43.7663	3.132521E-02	52.5891	12.3970	141.185	0.796016	-37.3172
4.0E+08	0.531768	-54.0028	3.681579E-02	44.5019	10.9257	132.570	0.708892	-45.4503
5.0E+08	0.471795	-62.3880	4.057046E-02	38.2308	9.62995	125.781	0.633146	-51.7704
6.0E+08	0.421506	-69.3569	4.316292E-02	33.3405	8.53559	120.378	0.570209	-56.7206
7.0E+08	0.379961	-75.2612	4.499071E-02	29.4764	7.62375	116.005	0.518803	-60.6598
8.0E+08	0.345693	-80.3608	4.631140E-02	26.3755	6.86423	112.398	0.476987	-63.8540
9.0E+08	0.317301	-84.8420	4.728948E-02	23.8481	6.22797	109.365	0.442915	-66.4948
1.0E+09	0.293608	-88.8381	4.803091E-02	21.7581	5.69057	106.771	0.415044	-68.7193
1.1E+09	0.273680	-92.4452	4.860515E-02	20.0070	5.23257	104.518	0.392146	-70.6269
1.2E+09	0.256782	-95.7336	4.905871E-02	18.5224	4.83873	102.532	0.373261	-72.2899
1.3E+09	0.242344	-98.7555	4.942344E-02	17.2505	4.49716	100.759	0.357640	-73.7620
1.4E+09	0.229918	-101.551	4.972158E-02	16.1506	4.19854	99.1602	0.344698	-75.0832
1.5E+09	0.219152	-104.150	4.996903E-02	15.1915	3.93554	97.7028	0.333974	-76.2840
1.6E+09	0.209767	-106.577	5.017730E-02	14.3490	3.70234	96.3629	0.325102	-77.3877
1.7E+09	0.201539	-108.851	5.035491E-02	13.6040	3.49428	95.1215	0.317789	-78.4122
1.8E+09	0.194288	-110.988	5.050825E-02	12.9411	3.30758	93.9633	0.311800	-79.3715
1.9E+09	0.187867	-113.001	5.064218E-02	12.3482	3.13919	92.8761	0.306940	-80.2768
2.0E+09	0.182157	-114.902	5.076045E-02	11.8151	2.98658	91.8500	0.303051	-81.1365
2.1E+09	0.177056	-116.698	5.086598E-02	11.3338	2.84766	90.8766	0.300003	-81.9578
2.2E+09	0.172484	-118.399	5.096107E-02	10.8974	2.72068	89.9494	0.297686	-82.7460
2.3E+09	0.168370	-120.012	5.104755E-02	10.5001	2.60420	89.0626	0.296007	-83.5057
2.4E+09	0.164656	-121.542	5.112690E-02	10.1373	2.49697	88.2115	0.294889	-84.2405
2.5E+09	0.161293	-122.996	5.120031E-02	9.80479	2.39793	87.3920	0.294266	-84.9533
2.6E+09	0.158239	-124.378	5.126876E-02	9.49919	2.30619	86.6007	0.294081	-85.6466
2.7E+09	0.155458	-125.694	5.133304E-02	9.21750	2.22098	85.8348	0.294285	-86.3223
2.8E+09	0.152919	-126.947	5.139381E-02	8.95716	2.14162	85.0916	0.294836	-86.9822
2.9E+09	0.150595	-128.140	5.145164E-02	8.71595	2.06753	84.3690	0.295696	-87.6275
3.0E+09	0.148463	-129.279	5.150697E-02	8.49194	1.99820	83.6651	0.296834	-88.2595

# HFA3102

## Die Characteristics

**PROCESS:**  
UHF-1

**DIE DIMENSIONS:**  
53 x 52 x 14 ±1mils  
1340µm x 1320µm x 355.6µm ± 25.4µm

**METALIZATION:**  
Type: Metal 1: AlCu(2%)/TiW      Type: Metal 2: AlCu(2%)  
Thickness: Metal 1: 8kÅ ± 0.5kÅ      Thickness: Metal 2: 16kÅ ± 0.8kÅ

**GLASSIVATION:**  
Type: Nitride  
Thickness: 4kÅ ± 0.5kÅ

**DIE ATTACH:**  
Material: Epoxy

**WORST CASE CURRENT DENSITY:**  
 $1.50 \times 10^5 \text{ A/cm}^2$

## Metallization Mask Layout

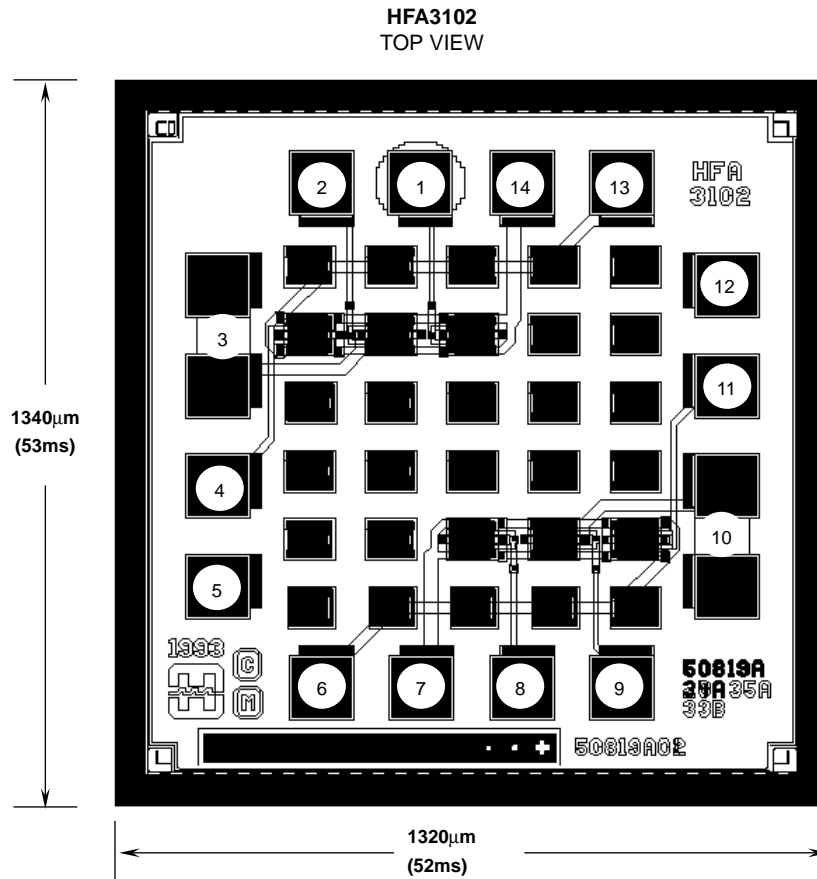

Pad numbers correspond to the 14 pin SOIC pinout.