

March 1993

High-Voltage Transistor Arrays

Features

- Matched General Purpose Transistors
- V_{BE} Matched $\pm 5mV$ Max
- Operation from DC to 120MHz (CA3146, A)
- Low Noise Figure: 3.2dB Typ at 1kHz (CA3146, A)
- High I_C : 75mA Max (CA3183, A)

Applications

- General Use in Signal Processing Systems in DC through VHF Range
- Custom Designed Differential Amplifiers
- Temperature Compensated Amplifiers
- Lamp and Relay Drivers (CA3183, A)
- Thyristor Firing (CA3183, A)

Ordering Information

| PART NUMBER | TEMPERATURE RANGE | PACKAGE |
|-------------|-------------------|---------------------------|
| CA3146AE | -40°C to +85°C | 14 Lead Plastic DIP |
| CA3146AM | -40°C to +85°C | 14 Lead SOIC |
| CA3146AM96 | -40°C to +85°C | 14 Lead SOIC* |
| CA3146E | -40°C to +85°C | 14 Lead Plastic DIP |
| CA3146M | -40°C to +85°C | 14 Lead SOIC |
| CA3146M96 | -40°C to +85°C | 14 Lead SOIC* |
| CA3183AE | -40°C to +85°C | 16 Lead Plastic DIP |
| CA3183AM | -40°C to +85°C | 16 Lead Narrow Body SOIC |
| CA3183AM96 | -40°C to +85°C | 16 Lead Narrow Body SOIC* |
| CA3183E | -40°C to +85°C | 16 Lead Plastic DIP |
| CA3183M | -40°C to +85°C | 16 Lead Narrow Body SOIC |
| CA3183M96 | -40°C to +85°C | 16 Lead Narrow Body SOIC* |

*Denotes Tape and Reel

Description

The CA3146A, CA3146, CA3183A, and CA3183* are general purpose high voltage silicon n-p-n transistor arrays on a common monolithic substrate.

Types CA3146A and CA3146 consist of five transistors with two of the transistors connected to form a differentially connected pair. These types are recommended for low power applications in the DC through VHF range. (CA3146A and CA3146 are high voltage versions of the popular predecessor type CA3046.)

Types CA3183A and CA3183 consist of five high current transistors with independent connections for each transistor. In addition two of these transistors (Q1 and Q2) are matched at low current (i.e. 1mA) for applications where offset parameters are of special importance. A special substrate terminal is also included for greater flexibility in circuit design. (CA3183A and CA3183 are high voltage versions of the popular predecessor type CA3083.)

The types with an "A" suffix are premium versions of their non-"A" counterparts and feature tighter control of breakdown voltages making them more suitable for higher voltage applications.

For detailed application information, see companion Application Note AN5296 "Application of the CA3018 Integrated Circuit Transistor Array."

* Formerly Developmental Types Nos.

CA3146A - TA6084

CA3183A - TA6094

CA3146 - TA6181

CA3183 - TA6183

Pinouts

CA3146, A (PDIP, SOIC)
TOP VIEW

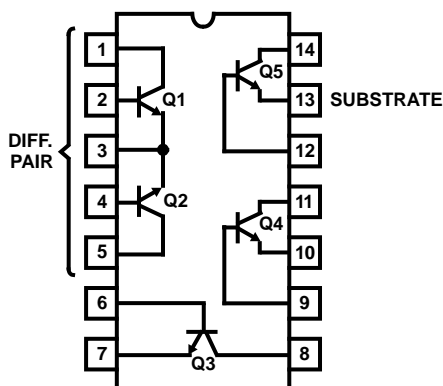

CA3183, A (PDIP, 150MIL SOIC)
TOP VIEW

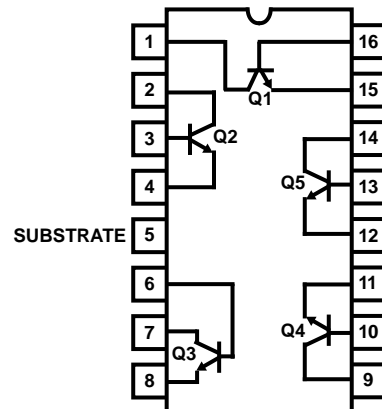

Specifications CA3146, CA3146A, CA3183, CA3183A

Absolute Maximum Ratings

Power Dissipation: (any one transistor)
 CA3146A, CA3146300mW
 CA3183A, CA3183500mW

Total Package
 Up to +55°C (CA3146A, CA3146, CA3183A, CA3183)750mW
 Above +55°C Derate Linearly 6.67mW/°C
 (CA3146, A, CA3183, A)

The following ratings apply for each transistor in the device:

Collector-to-Emitter Voltage (V_{CEO}):
 CA3146A, CA3183A40V
 CA3146, CA318330V

Collector-to-Base Voltage (V_{CBO}):
 CA3146A, CA3183A50V
 CA3146, CA318340V

Collector-to-Substrate Voltage (V_{CISO}): (Note 1)
 CA3146A, CA3183A50V
 CA3146, CA318340V

Emitter-to-Base Voltage (V_{EBO}) all types5V

Collector Current
 CA3146A, CA3146 50mA
 CA3183 75mA

Base Current (I_B) - CA3183A, CA3183. 20mA

Junction Temperature+175°C
 Junction Temperature (Plastic Package) +150°C
 Lead Temperature (Soldering 10 Sec.) +300°C

Operating Conditions

Operating Temperature Range
 CA3146A, CA3146, CA3183A, CA3183 -40°C to +85°C
 Storage Temperature Range (all types) -65°C to +150°C

CAUTION: Stresses above those listed in "Absolute Maximum Ratings" may cause permanent damage to the device. This is a stress only rating and operation of the device at these or any other conditions above those indicated in the operational sections of this specification is not implied.

Values Apply For Each Transistor

| TYPE | (NOTE 2) P_T MAX. (mW) | I_C MAX. (mA) | V_{CEO} (MAX) (V) | V_{CBO} (MAX) (V) | $V_{CE SAT}$ AT 10mA TYP (V) | h_{FE} AT 1mA, & $V_{CE} = 5V$ (TYP) | DIFF. PAIR AT 1mA | | T_A RANGE (OPERATING) |
|----------------------------------|--------------------------------|--------------------|---------------------------|---------------------------|------------------------------------|--|----------------------|----------------------------|----------------------------|
| | | | | | | | V_{IO} MAX (mV) | I_{IO} MAX (μ A) | |
| VALUES APPLY FOR EACH TRANSISTOR | | | | | | | | | |
| CA3146A | 300 | 50 | 40 | 50 | 0.33 | 100 | ± 5 | 2 | -40°C to +85°C |
| CA3146 | 300 | 50 | 30 | 40 | 0.33 | 100 | ± 5 | 2 | -40°C to +85°C |
| CA3183A | 500 | 75 | 40 | 50 | 0.16 | 75 | ± 5 | 2.5 | -40°C to +85°C |
| CA3183 | 500 | 75 | 30 | 40 | 0.16 | 75 | ± 5 | 2.5 | -40°C to +85°C |

Comparison Of Related Predecessor Type with Types in this Data Sheet

| TYPE | V_{CEO} MIN (V) | V_{CBO} MIN (V) | $V_{CE SAT}$ TYP (V) | V_{BE} TYP (V) | I_C MAX (mA) | C_{CB} TYP (pF) | C_{CI} TYP (pF) | C_{EB} TYP (pF) |
|---------|----------------------|----------------------|-------------------------|---------------------|-------------------|----------------------|----------------------|----------------------|
| CA3046 | 15 | 20 | $I_C = 10mA$ | $I_C = 1mA$ | 50 | 0.58 | 2.8 | 0.6 |
| | | | 0.23 | 0.715 | | | | |
| CA3146A | 40 | 50 | 0.33 | 0.730 | 50 | 0.37 | 2.2 | 0.7 |
| CA3146 | 30 | 40 | 0.33 | 0.730 | 50 | 0.37 | 2.2 | 0.7 |

Specifications CA3146, CA3146A, CA3183, CA3183A

Comparison Of Related Predecessor Type with Types in this Data Sheet (Continued)

| TYPE | V _{CEO} MIN (V) | V _{CBO} MIN (V) | V _{CE SAT} TYP (V) | V _{BE} TYP (V) | I _C MAX (mA) | C _{CB} TYP (pF) | C _{CI} TYP (pF) | C _{EB} TYP (pF) |
|---------|--------------------------|--------------------------|-----------------------------|-------------------------|-------------------------|--------------------------|--------------------------|--------------------------|
| CA3083 | 15 | 20 | I _C = 50mA | I _C = 10mA | 100 | - | - | - |
| | | | 0.4 | 0.74 | | | | |
| CA3183A | 40 | 50 | 1.7 | 0.75 | 75 | - | - | - |
| CA3183 | 30 | 40 | 1.7 | 0.75 | 75 | - | - | - |

NOTES:

- The collector of each transistor is isolated from the substrate by an integral diode. The substrate must be connected to a voltage which is more negative than any collector voltage in order to maintain isolation between transistors, and to provide for normal transistor action. To avoid undesired coupling between transistors, the substrate terminal should be maintained at either DC or signal (AC) ground. A suitable bypass capacitor can be used to establish a signal ground.
- Caution on Total Package Power Dissipation: The maximum total package dissipation rating for the CA3146 and CA3183 Series circuits is 750mW at temperatures up to +55°C, then derate linearly at 6.67mW/°C.

Static Electrical Characteristics CA3146 Series

| PARAMETERS | SYMBOL | TEST CONDITIONS | | LIMITS | | | | | | UNITS |
|---|---|--|---------------------------|---------|-----------|------|--------|-----------|------|-------|
| | | T _A = +25°C | TYP. CHAR. CURVE FIG. NO. | CA3146A | | | CA3146 | | | |
| | | | | MIN | TYP | MAX | MIN | TYP | MAX | |
| For Each Transistor | | | | | | | | | | |
| Collector-to-Base Break-down Voltage | V _{(BR)CBO} | I _C = 10μA, I _E = 0 | - | 50 | 72 | - | 40 | 72 | - | V |
| Collector-to-Emitter Breakdown Voltage | V _{(BR)CEO} | I _C = 1mA, I _B = 0 | - | 40 | 56 | - | 30 | 56 | - | V |
| Collector-to-Substrate Breakdown Voltage | V _{(BR)CIO} | I _{CI} = 10μA, I _B = 0, I _E = 0 | - | 50 | 72 | - | 40 | 72 | - | V |
| Emitter-to-Base Breakdown Voltage | V _{(BR)EBO} | I _E = 10μA, I _C = 0 | - | 5 | 7 | - | 5 | 7 | - | V |
| Collector-Cutoff Current | I _{CEO} | V _{CE} = 10V, I _B = 0 | 2 | - | See Curve | 5 | - | See Curve | 5 | μA |
| Collector-Cutoff Current | I _{CBO} | V _{CB} = 10V, I _E = 0 | 3 | - | 0.002 | 100 | - | 0.002 | 100 | nA |
| DC Forward-Current Transfer Ratio | h _{FE} | V _{CE} = 5V, I _C = 10mA | 4 | - | 85 | - | - | 85 | - | - |
| | | V _{CE} = 5V, I _C = 1mA | 4 | 30 | 100 | - | 30 | 100 | - | - |
| | | V _{CE} = 5V, I _C = 10μA | 4 | - | 90 | - | - | 90 | - | - |
| Base-to-Emitter Voltage | V _{BE} | V _{CE} = 3V, I _C = 1mA | 5 | 0.63 | 0.73 | 0.83 | 0.63 | 0.73 | 0.83 | V |
| Collector-to-Emitter Sat-uration Voltage | V _{CE SAT} | I _C = 10mA, I _B = 1mA | 6 | - | 0.33 | - | - | 0.33 | - | V |
| For transistors Q3 and Q4 (Darlington Configuration): | | | | | | | | | | |
| Base-to-Emitter (Q3 to Q4) | V _{BE} | V _{CE} = 5V, I _E = 10mA | 8 | - | 1.46 | - | - | 1.46 | - | V |
| | | V _{CE} = 5V, I _E = 1mA | 8, 9 | - | 1.32 | - | - | 1.32 | - | V |
| Magnitude of Base-to-Emitter Temperature Co-efficient | $\left \frac{\Delta V_{BE}}{\Delta T} \right $ | V _{CE} = 5V, I _E = 1mA | - | - | 4.4 | - | - | 4.4 | - | mV/°C |

Specifications CA3146, CA3146A, CA3183, CA3183A

Static Electrical Characteristics CA3146 Series (Continued)

| PARAMETERS | SYMBOL | TEST CONDITIONS | | LIMITS | | | | | | UNITS |
|---|---|--|---------------------------|---------|------|-----|--------|------|-----|------------------------------|
| | | $T_A = +25^\circ\text{C}$ | TYP. CHAR. CURVE FIG. NO. | CA3146A | | | CA3146 | | | |
| | | | | MIN | TYP | MAX | MIN | TYP | MAX | |
| For transistors Q1 and Q2 (As a Differential Amplifier): | | | | | | | | | | |
| Magnitude of Input Offset Voltage $ V_{BE1} - V_{BE2} $ | $ V_{IO} $ | $V_{CE} = 5\text{V}, I_E = 1\text{mA}$ | 10, 11 | - | 0.48 | 5 | - | 0.48 | 5 | mV |
| Magnitude of Base-to-Emitter Temperature Coefficient | $\left \frac{\Delta V_{BE}}{\Delta T} \right $ | $V_{CE} = 5\text{V}, I_E = 1\text{mA}$ | - | - | 1.9 | - | - | 1.9 | - | $\text{mV}/^\circ\text{C}$ |
| Magnitude of V_{IO} ($V_{BE1} - V_{BE2}$) Temperature Coefficient | $\left \frac{\Delta V_{IO}}{\Delta T} \right $ | $V_{CE} = 5\text{V}, I_{C1} = I_{C2} = 1\text{mA}$ | - | - | 1.1 | - | - | 1.1 | - | $\mu\text{V}/^\circ\text{C}$ |
| Magnitude of Input Offset Current $ I_{IO1} - I_{IO2} $ | CA3146AE and CA3146E Only I_{IO} | $V_{CE} = 5\text{V}, I_{C1} = I_{C2} = 1\text{mA}$ | 12 | - | 0.3 | 2 | - | 0.3 | 2 | μA |

Dynamic Electrical Characteristics CA3146 Series

| PARAMETERS | SYMBOL | TEST CONDITIONS | | LIMITS | | | | | | UNITS |
|---|----------|--|---------------------------|---------|----------------------|-----|--------|----------------------|-----|------------------|
| | | $T_A = +25^\circ\text{C}$ | TYP. CHAR. CURVE FIG. NO. | CA3146A | | | CA3146 | | | |
| | | | | MIN | TYP | MAX | MIN | TYP | MAX | |
| Low Frequency Noise Figure | NF | $f = 1\text{kHz}, V_{CE} = 5\text{V}, I_C = 100\mu\text{A},$ Source resistance = $1\text{k}\Omega$ | 14 | - | 3.25 | - | - | 3.25 | - | dB |
| Low-Frequency, Small-Signal Equivalent-Circuit Characteristics: | | | | | | | | | | |
| Forward-Current Transfer Ratio | h_{FE} | $f = 1\text{kHz}, V_{CE} = 5\text{V}, I_C = 1\text{mA}$ | 16 | - | 100 | - | - | 100 | - | - |
| Short-Circuit Input Impedance | h_{iE} | $f = 1\text{kHz}, V_{CE} = 5\text{V}, I_C = 1\text{mA}$ | 16 | - | 2.7 | - | - | 3.5 | - | $\text{k}\Omega$ |
| Open-Circuit Output Impedance | h_{oE} | $f = 1\text{kHz}, V_{CE} = 5\text{V}, I_C = 1\text{mA}$ | 16 | - | 15.6 | - | - | 15.6 | - | μmho |
| Open-Circuit Reverse Voltage Transfer Ratio | h_{rE} | $f = 1\text{kHz}, V_{CE} = 5\text{V}, I_C = 1\text{mA}$ | 16 | - | 1.8×10^{-4} | - | - | 1.8×10^{-4} | - | - |
| Admittance Characteristics: | | | | | | | | | | |
| Forward Transfer Admittance | Y_{FE} | $f = 1\text{MHz}, V_{CE} = 5\text{V}, I_C = 1\text{mA}$ | 17 | - | 31-j1.5 | - | - | 31-j1.5 | - | mmho |
| Input Admittance | Y_{iE} | $f = 1\text{MHz}, V_{CE} = 5\text{V}, I_C = 1\text{mA}$ | 18 | - | $0.35 + j0.04$ | - | - | $0.3 + j0.04$ | - | mmho |
| Output Admittance | Y_{oE} | $f = 1\text{MHz}, V_{CE} = 5\text{V}, I_C = 1\text{mA}$ | 19 | - | $0.001 + j0.03$ | - | - | $0.001 + j0.03$ | - | mmho |
| Reverse Transfer Admittance | Y_{rE} | $f = 1\text{MHz}, V_{CE} = 5\text{V}, I_C = 1\text{mA}$ | 20 | - | See Curve | - | - | See Curve | - | mmho |

Specifications CA3146, CA3146A, CA3183, CA3183A

Dynamic Electrical Characteristics CA3146 Series (Continued)

| PARAMETERS | SYMBOL | TEST CONDITIONS | | LIMITS | | | | | | UNITS |
|------------------------------------|----------|--|---------------------------|---------|------|-----|--------|------|-----|-------|
| | | $T_A = +25^\circ\text{C}$ | TYP. CHAR. CURVE FIG. NO. | CA3146A | | | CA3146 | | | |
| | | | | MIN | TYP | MAX | MIN | TYP | MAX | |
| Gain-Bandwidth Product | f_T | $V_{CE} = 5\text{V}, I_C = 3\text{mA}$ | 21 | 300 | 500 | - | 300 | 500 | - | MHz |
| Emitter-to-Base Capacitance | C_{EB} | $V_{EB} = 5\text{V}, I_E = 0$ | 22 | - | 0.70 | - | - | 0.70 | - | pF |
| Collector-to-Base Capacitance | C_{CB} | $V_{CB} = 5\text{V}, I_C = 0$ | 22 | - | 0.37 | - | - | 0.37 | - | pF |
| Collector-to-Substrate Capacitance | C_{CI} | $V_{CI} = 5\text{V}, I_C = 0$ | 22 | - | 2.2 | - | - | 2.2 | - | pF |

Static Electrical Characteristics CA3183 Series

| PARAMETERS | SYMBOL | TEST CONDITIONS | | LIMITS | | | | | | UNITS |
|--|------------------------------|---|---------------------------|---------|------|------|--------|------|------|---------------|
| | | $T_A = +25^\circ\text{C}$ | TYP. CHAR. CURVE FIG. NO. | CA3183A | | | CA3183 | | | |
| | | | | MIN | TYP | MAX | MIN | TYP | MAX | |
| For Each Transistor: | | | | | | | | | | |
| Collector-to-Base Breakdown Voltage | $V_{(BR)CBO}$ | $I_C = 100\mu\text{A}, I_E = 0$ | - | 50 | - | - | 40 | - | - | V |
| Collector-to-Emitter Breakdown Voltage | $V_{(BR)CEO}$ | $I_C = 1\text{mA}, I_B = 0$ | - | 40 | - | - | 30 | - | - | V |
| Collector-to-Substrate Breakdown Voltage | $V_{(BR)CIO}$ | $I_{CI} = 100\mu\text{A}, I_B = 0, I_E = 0$ | - | 50 | - | - | 40 | - | - | V |
| Emitter-to-Base Breakdown Voltage | $V_{(BR)EBO}$ | $I_E = 500\mu\text{A}, I_C = 0$ | - | 5 | - | - | 5 | - | - | V |
| Collector-Cutoff Current | I_{CEO} | $V_{CE} = 10\text{V}, I_B = 0$ | 23 | - | - | 10 | - | - | 10 | μA |
| Collector-Cutoff Current | I_{CBO} | $V_{CB} = 10\text{V}, I_E = 0$ | 24 | - | - | 1 | - | - | 1 | μA |
| DC Forward-Current Transfer Ratio | h_{FE} | $V_{CE} = 3\text{V}, I_C = 10\text{mA}$ | 25, 26 | 40 | - | - | 40 | - | - | - |
| | | $V_{CE} = 5\text{V}, I_C = 50\text{mA}$ | - | 40 | - | - | 40 | - | - | - |
| Base-to-Emitter Voltage | V_{BE} | $V_{CE} = 3\text{V}, I_C = 10\text{mA}$ | 27 | 0.65 | 0.75 | 0.85 | 0.65 | 0.75 | 0.85 | V |
| Collector-to-Emitter Saturation Voltage | $V_{CE\text{ SAT}}$ (Note 1) | $I_C = 50\text{mA}, I_B = 5\text{mA}$ | 28 | - | 1.7 | 3.0 | - | 1.7 | 3.0 | V |
| For Transistors Q1 and Q2 (As a Differential Amplifier): | | | | | | | | | | |
| Absolute Input Offset Voltage | $ V_{IO} $ | $V_{CE} = 3\text{V}, I_C = 1\text{mA}$ | 29 | - | 0.47 | 5 | - | 0.47 | 5 | mV |
| Absolute Input Offset Current | $ I_{IO} $ | $V_{CE} = 3\text{V}, I_C = 1\text{mA}$ | 30 | - | 0.78 | 2.5 | - | 0.78 | 2.5 | μA |

NOTE:

1. A maximum dissipation of 5 transistors x 150mW = 750mW is possible for a particular application.

Typical Performance Curves Static Characteristics - CA3146 Series

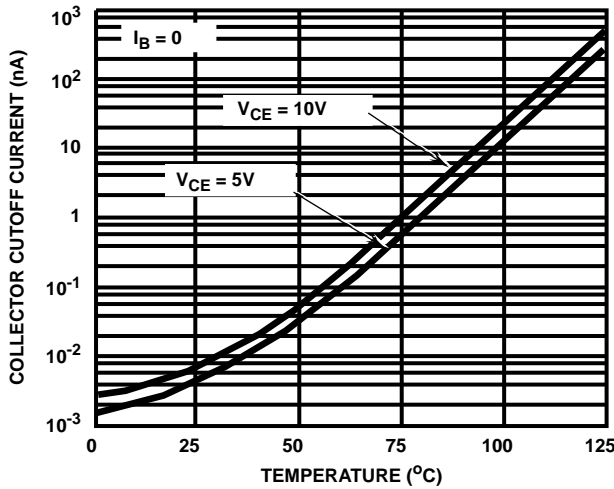

FIGURE 1. I_{CEO} vs TEMPERATURE FOR ANY TRANSISTOR

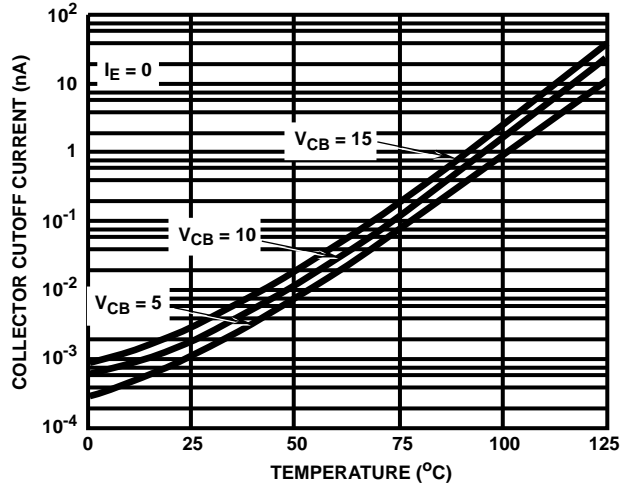

FIGURE 2. I_{CBO} vs TEMPERATURE FOR ANY TRANSISTOR

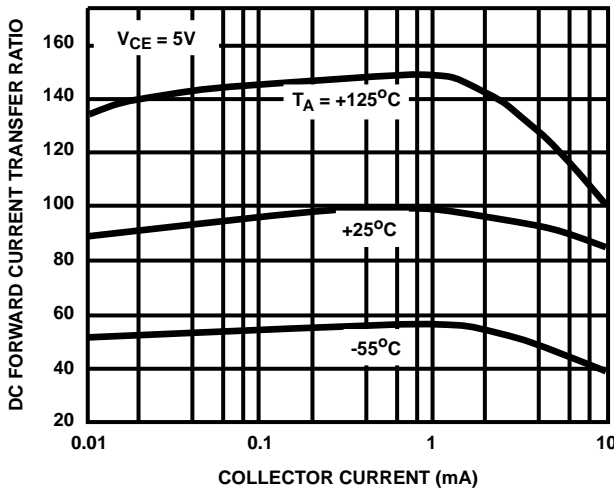

FIGURE 3. h_{FE} vs I_C FOR ANY TRANSISTOR

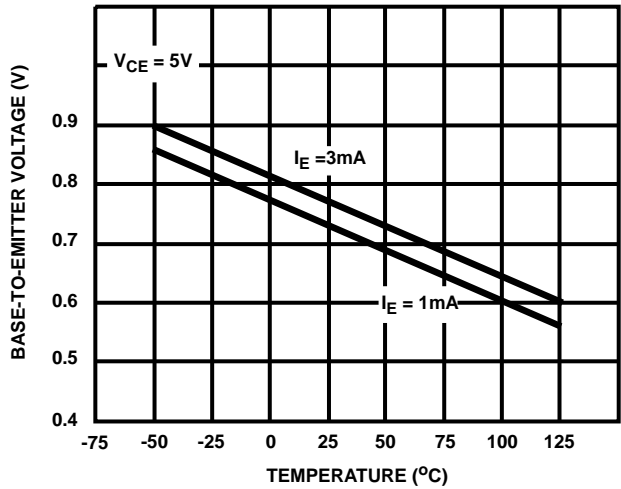

FIGURE 4. V_{BE} vs TEMPERATURE FOR ANY TRANSISTOR

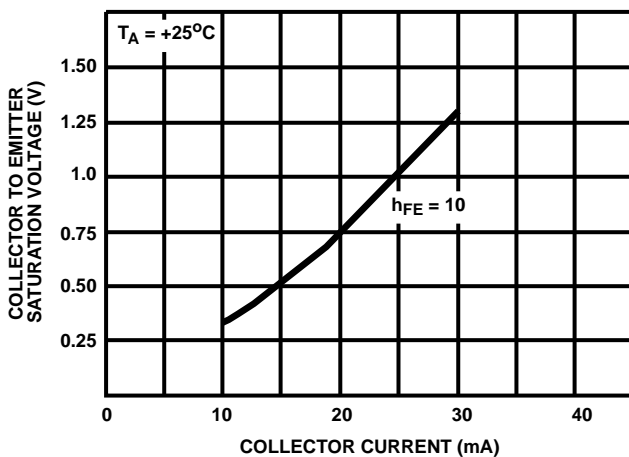

FIGURE 5. $V_{CE SAT}$ vs I_C FOR ANY TRANSISTOR

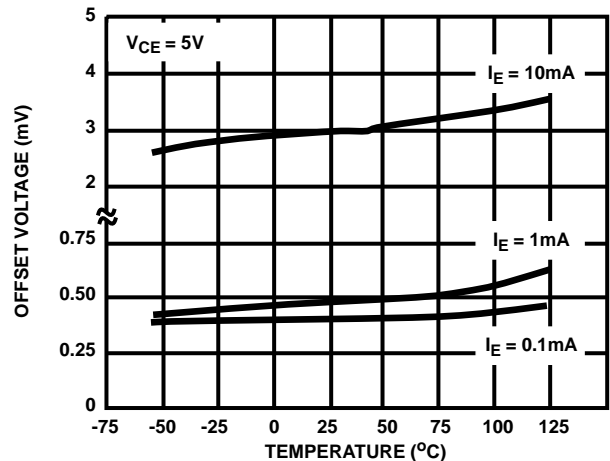

FIGURE 6. V_{IO} vs TEMPERATURE FOR Q1 AND Q2

Typical Performance Curves Static Characteristics - CA3146 Series (Continued)

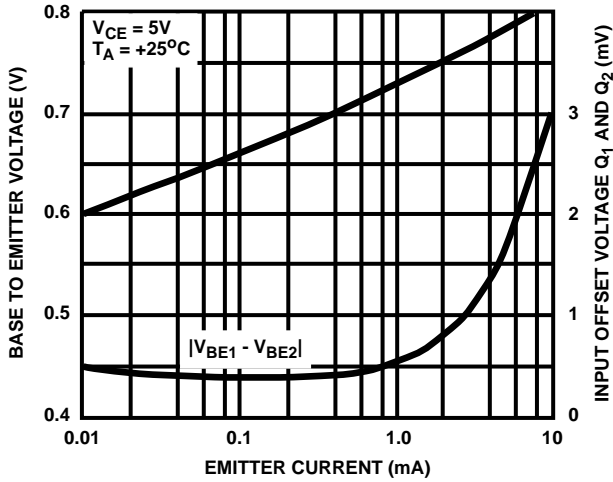

FIGURE 7. V_{BE} AND V_{IO} vs I_E FOR Q1 AND Q2

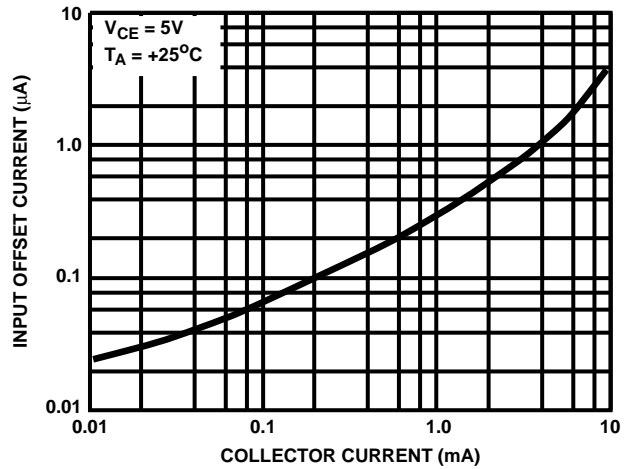

FIGURE 8. I_{IO} vs I_C (Q1 AND Q2) FOR TYPES CA3146A AND CA3146

Typical Performance Curves Dynamic Characteristics (for any transistor) - CA3146 Series

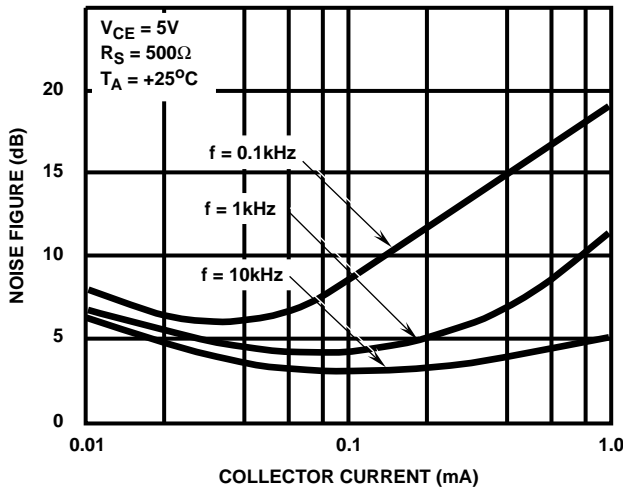

FIGURE 9. NF vs I_C AT $R_S = 500\Omega$

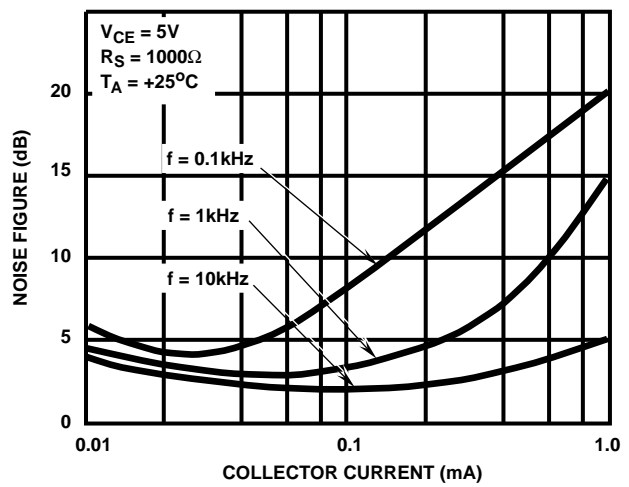

FIGURE 10. NF vs I_C AT $R_S = 1k\Omega$

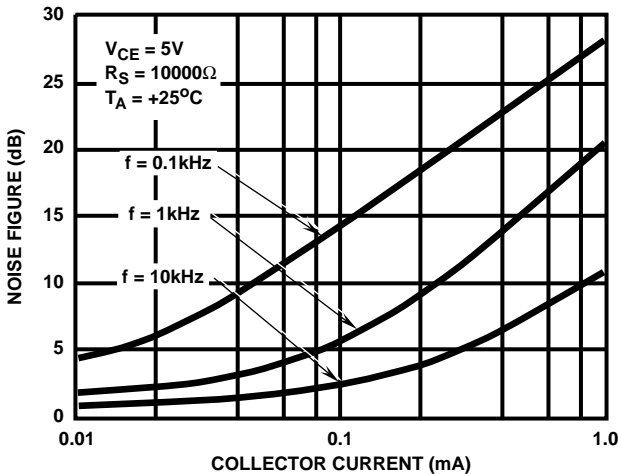

FIGURE 11. NF vs I_C AT $R_S = 10k\Omega$

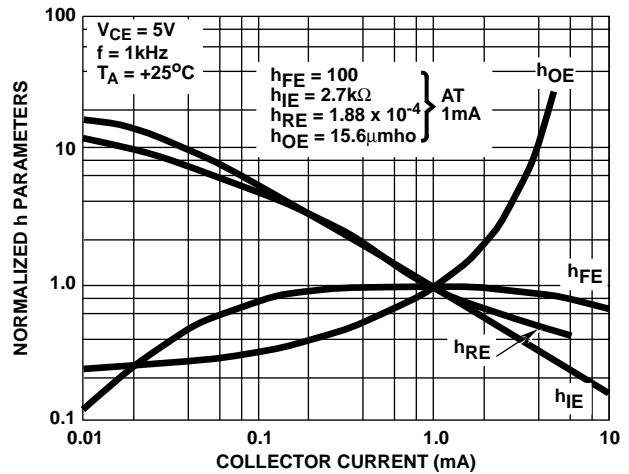

FIGURE 12. h_{FE} , h_{IE} , h_{OE} , h_{RE} vs I_C

Typical Performance Curves Dynamic Characteristics (for any transistor) - CA3146 Series (Continued)

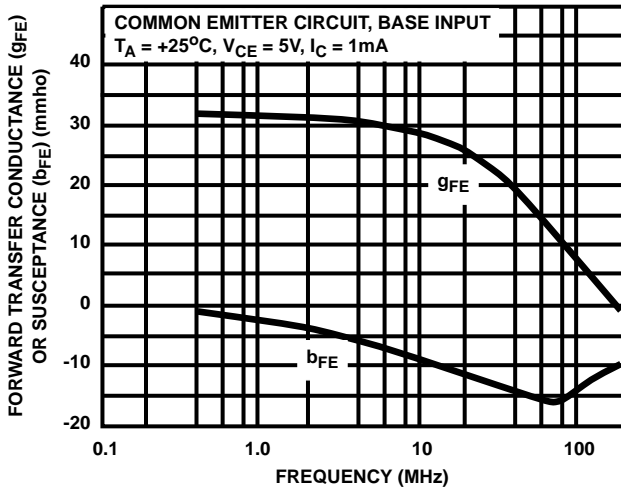

FIGURE 13. y_{FE} vs FREQUENCY

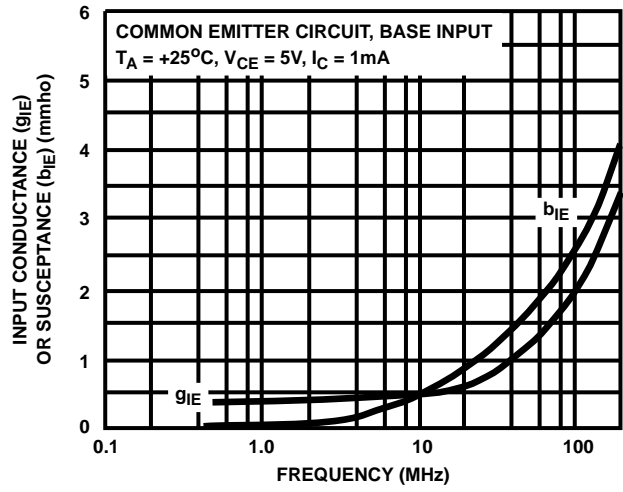

FIGURE 14. y_{IE} vs FREQUENCY

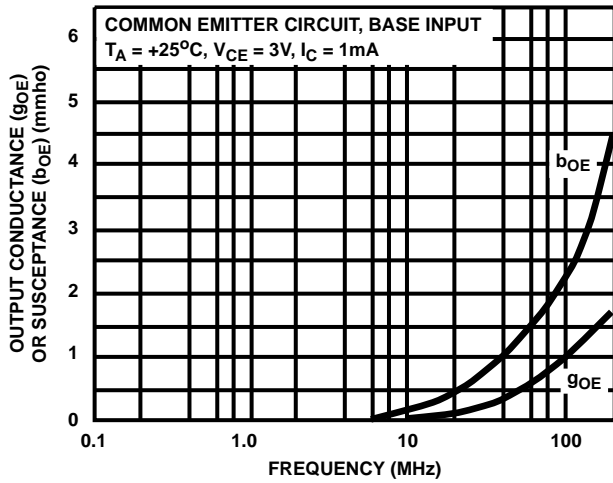

FIGURE 15. y_{OE} vs FREQUENCY

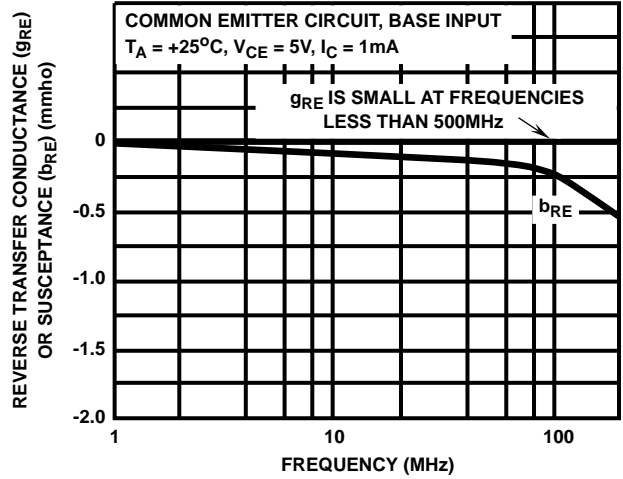

FIGURE 16. y_{RE} vs FREQUENCY

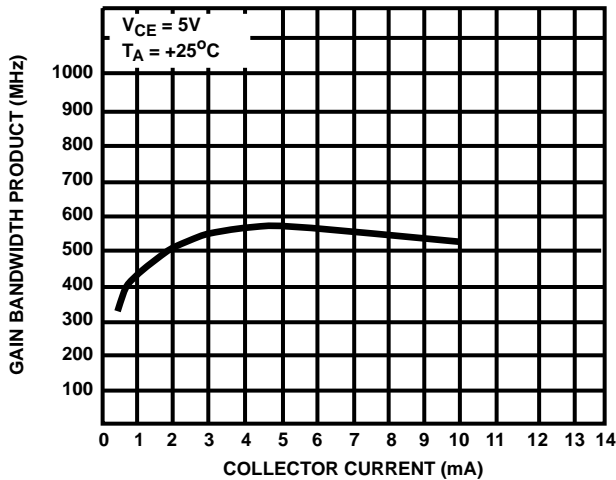

FIGURE 17. f_T vs I_C

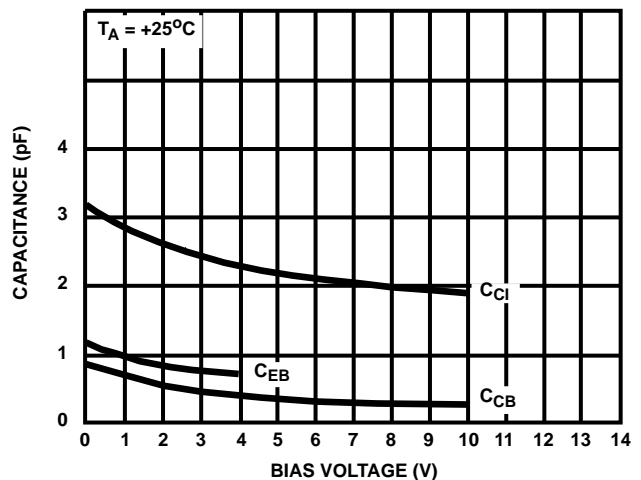

FIGURE 18. C_{EB} , C_{CB} , C_{CI} vs BIAS VOLTAGE

Typical Performance Curves Static Characteristics - CA3183 Series

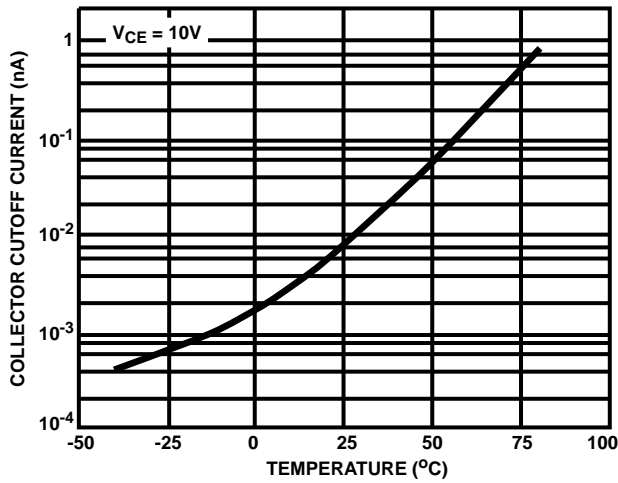

FIGURE 19. I_{CEO} vs TEMPERATURE FOR ANY TRANSISTOR

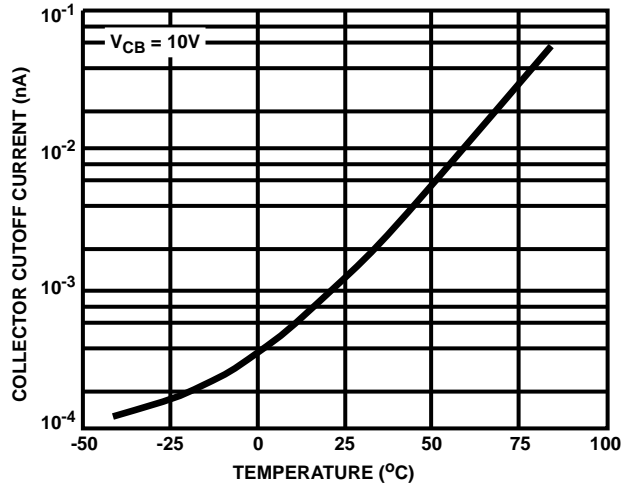

FIGURE 20. I_{CBO} vs TEMPERATURE FOR ANY TRANSISTOR

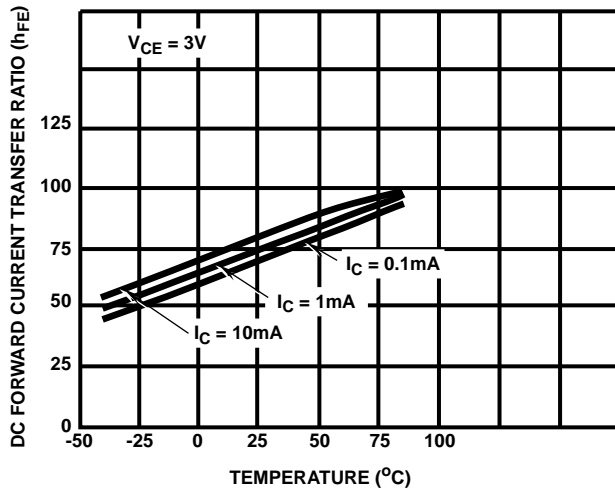

FIGURE 21. h_{FE} vs TEMPERATURE FOR ANY TRANSISTOR

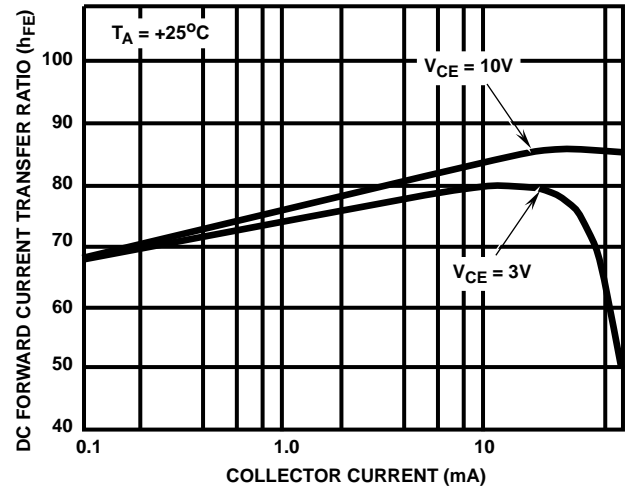

FIGURE 22. h_{FE} vs I_C FOR ANY TRANSISTOR

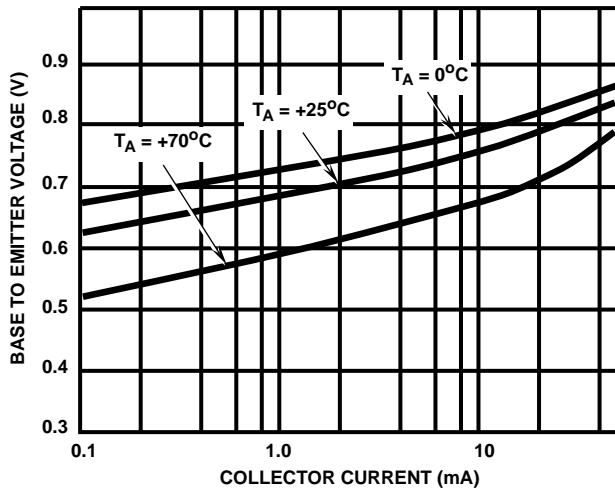

FIGURE 23. V_{BE} vs I_C FOR ANY TRANSISTOR

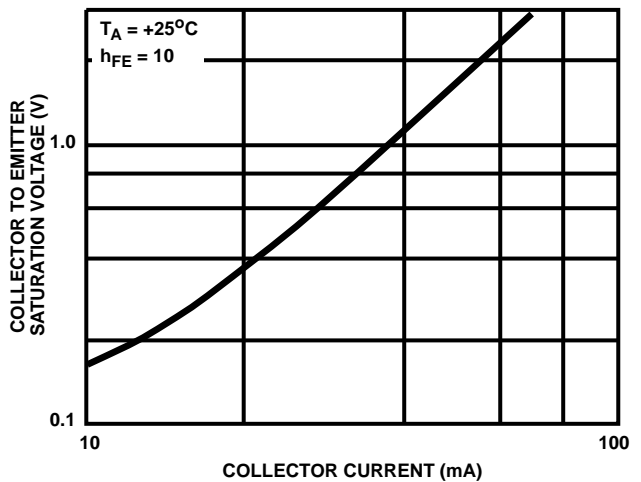

FIGURE 24. $V_{CE SAT}$ vs I_C FOR ANY TRANSISTOR

Typical Performance Curves Static Characteristics - CA3183 Series (Continued)

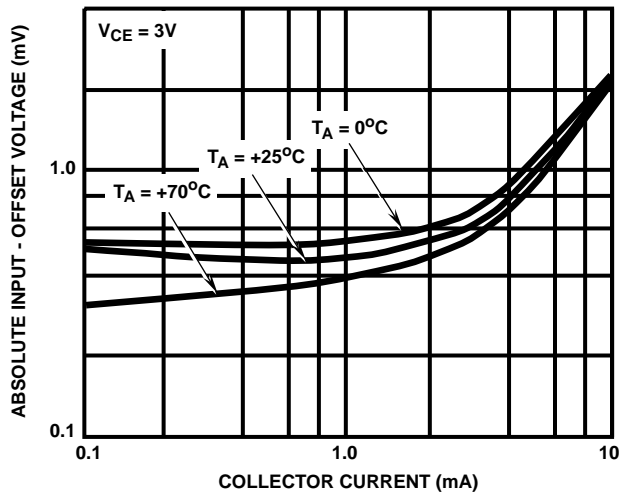

FIGURE 25. $|V_{IO}|$ vs I_C FOR DIFFERENTIAL AMPLIFIER (Q1 AND Q2)

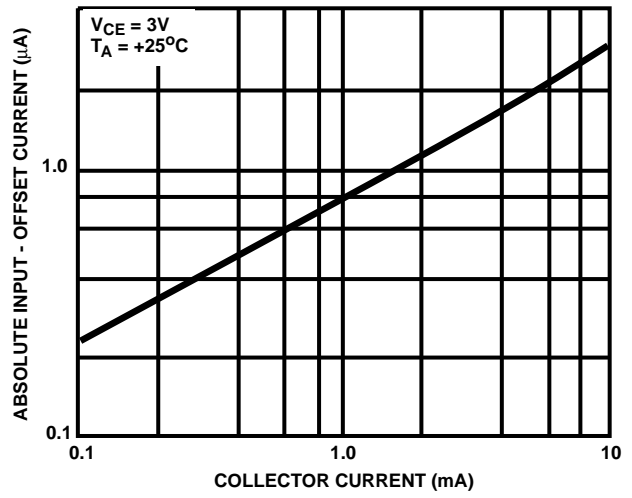

FIGURE 26. $|I_O|$ vs I_C FOR DIFFERENTIAL AMPLIFIER (Q1 AND Q2)