

## Thunderbolt® High Speed NPT IGBT with Anti-Parallel 'DQ' Diode

The Thunderbolt HS™ series is based on thin wafer non-punch through (NPT) technology similar to the Thunderbolt® series, but trades higher  $V_{CE(ON)}$  for significantly lower turn-on energy  $E_{off}$ . The low switching losses enable operation at switching frequencies over 100kHz, approaching power MOSFET performance but lower cost.

An extremely tight parameter distribution combined with a positive  $V_{CE(ON)}$  temperature coefficient make it easy to parallel Thunderbolts HS™ IGBT's. Controlled slew rates result in very good noise and oscillation immunity and low EMI. The short circuit duration rating of 10 $\mu$ s make these IGBT's suitable for motor drive and inverter applications. Reliability is further enhanced by avalanche energy ruggedness. Combi versions are packaged with a high speed, soft recovery DQ series diode.

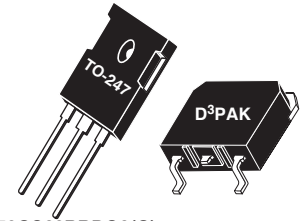

APT50GS60BRDQ2(G)  
APT50GS60SRDQ2(G)

Single die IGBT with separate DQ diode die

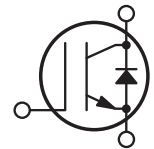

### Features

- Fast Switching with low EMI
- Very Low  $E_{OFF}$  for Maximum Efficiency
- Short circuit rated
- Low Gate Charge
- Tight parameter distribution
- Easy paralleling
- RoHS Compliant 

### Typical Applications

- ZVS Phase Shifted and other Full Bridge
- Half Bridge
- High Power PFC Boost
- Welding
- Induction heating
- High Frequency SMPS

### Absolute Maximum Ratings

Symbol	Parameter	Rating	Unit	
$I_{C1}$	Continuous Collector Current $T_C = @ 25^\circ C$	93	A	
$I_{C1}$	Continuous Collector Current $T_C = @ 100^\circ C$	50		
$I_{CM}$	Pulsed Collector Current <sup>①</sup>	195		
$V_{GE}$	Gate-Emitter Voltage	$\pm 30V$	V	
SSOA	Switching Safe Operating Area	195		
$E_{AS}$	Single Pulse Avalanche Energy <sup>②</sup>	280	mJ	
$t_{SC}$	Short Circuit Withstand Time <sup>③</sup>	10	$\mu$ s	
$I_F$	Diode Continuous Forward Current	$T_C = 25^\circ C$	90	A
		$T_C = 100^\circ C$	55	
$I_{FRM}$	Diode Max. Repetitive Forward Current	195		

### Thermal and Mechanical Characteristics

Symbol	Parameter	Min	Typ	Max	Unit
$P_D$	Total Power Dissipation $T_C = @ 25^\circ C$	-	-	415	W
$R_{\theta JC}$	Junction to Case Thermal Resistance	IGBT	-	0.30	$^\circ C/W$
		Diode	-	0.67	
$R_{\theta CS}$	Case to Sink Thermal Resistance, Flat Greased Surface	-	0.11	-	
$T_J, T_{STG}$	Operating and Storage Junction Temperature Range	-55	-	150	$^\circ C$
$T_L$	Soldering Temperature for 10 Seconds (1.6mm from case)	-	-	300	
$W_T$	Package Weight	-	0.22	-	oz
		-	5.9	-	g
Torque	Mounting Torque (TO-247), 6-32 M3 Screw	-	-	10	in-lbf
		-	-	1.1	N·m

 **CAUTION:** These Devices are Sensitive to Electrostatic Discharge. Proper Handling Procedures Should be Followed.

**Static Characteristics**
**T<sub>J</sub> = 25°C unless otherwise specified**
**APT50GS60B\_SRDQ2(G)**

Symbol	Parameter	Test Conditions	Min	Typ	Max	Unit	
V <sub>BR(CES)</sub>	Collector-Emitter Breakdown Voltage	V <sub>GE</sub> = 0V, I <sub>C</sub> = 250μA	600	-	-	V	
ΔV <sub>BR(CES)</sub> /ΔT <sub>J</sub>	Breakdown Voltage Temperature Coeff	Reference to 25°C, I <sub>C</sub> = 250μA	-	0.60	-	V/°C	
V <sub>CE(ON)</sub>	Collector-Emitter On Voltage <sup>④</sup>	V <sub>GE</sub> = 15V I <sub>C</sub> = 50A	T <sub>J</sub> = 25°C	-	2.8	3.15	V
			T <sub>J</sub> = 125°C	-	3.25	-	
V <sub>EC</sub>	Diode Forward Voltage <sup>④</sup>	I <sub>C</sub> = 50A	T <sub>J</sub> = 25°C	-	2.15	-	
			T <sub>J</sub> = 125°C	-	1.8	-	
V <sub>GE(th)</sub>	Gate-Emitter Threshold Voltage	V <sub>GE</sub> = V <sub>CE</sub> , I <sub>C</sub> = 1mA	3	4	5	mV/°C	
ΔV <sub>GE(th)</sub> /ΔT <sub>J</sub>	Threshold Voltage Temp Coeff		-	6.7	-		
I <sub>CES</sub>	Zero Gate Voltage Collector Current	V <sub>CE</sub> = 600V, V <sub>GE</sub> = 0V	T <sub>J</sub> = 25°C	-	-	50	μA
			T <sub>J</sub> = 125°C	-	-	TBD	
I <sub>GES</sub>	Gate-Emitter Leakage Current	V <sub>GE</sub> = ±20V	-	-	±100	nA	

**Dynamic Characteristics**
**T<sub>J</sub> = 25°C unless otherwise specified**

Symbol	Parameter	Test Conditions	Min	Typ	Max	Unit
g <sub>fs</sub>	Forward Transconductance	V <sub>CE</sub> = 50V, I <sub>C</sub> = 50A	-	31	-	S
C <sub>ies</sub>	Input Capacitance	V <sub>GE</sub> = 0V, V <sub>CE</sub> = 25V f = 1MHz	-	2635	-	pF
C <sub>oes</sub>	Output Capacitance		-	240	-	
C <sub>res</sub>	Reverse Transfer Capacitance		-	145	-	
C <sub>o(cr)</sub>	Reverse Transfer Capacitance Charge Related <sup>⑤</sup>	V <sub>GE</sub> = 0V V <sub>CE</sub> = 0 to 400V	-	115	-	
C <sub>o(er)</sub>	Reverse Transfer Capacitance Current Related <sup>⑥</sup>		-	85	-	
Q <sub>g</sub>	Total Gate Charge	V <sub>GE</sub> = 0 to 15V I <sub>C</sub> = 50A, V <sub>CE</sub> = 300V	-	235	-	nC
Q <sub>ge</sub>	Gate-Emitter Charge		-	18	-	
G <sub>gc</sub>	Gate-Collector Charge		-	100	-	
t <sub>d(on)</sub>	Turn-On Delay Time	Inductive Switching IGBT and Diode:  T <sub>J</sub> = 25°C, V <sub>CC</sub> = 400V, I <sub>C</sub> = 50A R <sub>G</sub> = 4.7Ω <sup>⑦</sup> , V <sub>GG</sub> = 15V	-	16	-	ns
t <sub>r</sub>	Rise Time		-	33	-	
t <sub>d(off)</sub>	Turn-Off Delay Time		-	225	-	
t <sub>f</sub>	Fall Time		-	37	-	
E <sub>on1</sub>	Turn-On Switching Energy <sup>⑧</sup>		-	TBD	-	
E <sub>on2</sub>	Turn-On Switching Energy <sup>⑨</sup>	Inductive Switching IGBT and Diode:  T <sub>J</sub> = 125°C, V <sub>CC</sub> = 400V, I <sub>C</sub> = 50A R <sub>G</sub> = 4.7Ω <sup>⑦</sup> , V <sub>GG</sub> = 15V	-	1.2	-	mJ
E <sub>off</sub>	Turn-Off Switching Energy <sup>⑩</sup>		-	0.755	-	
t <sub>d(on)</sub>	Turn-On Delay Time		-	33	-	
t <sub>r</sub>	Rise Time	Inductive Switching IGBT and Diode:  T <sub>J</sub> = 125°C, V <sub>CC</sub> = 400V, I <sub>C</sub> = 50A R <sub>G</sub> = 4.7Ω <sup>⑦</sup> , V <sub>GG</sub> = 15V	-	33	-	ns
t <sub>d(off)</sub>	Turn-Off Delay Time		-	250	-	
t <sub>f</sub>	Fall Time		-	23	-	
E <sub>on1</sub>	Turn-On Switching Energy <sup>⑧</sup>		-	TBD	-	
E <sub>on2</sub>	Turn-On Switching Energy <sup>⑨</sup>		-	1.7	-	
E <sub>off</sub>	Turn-Off Switching Energy <sup>⑩</sup>	I <sub>F</sub> = 50A V <sub>R</sub> = 400V di <sub>F</sub> /dt = 200A/μs	-	0.950	-	mJ
t <sub>rr</sub>	Diode Reverse Recovery Time		-	25	-	
Q <sub>rr</sub>	Diode Reverse Recovery Charge		-	35	-	
I <sub>rrm</sub>	Peak Reverse Recovery Current		-	3	-	A

# TYPICAL PERFORMANCE CURVES

APT50GS60B\_SRDQ2(G)

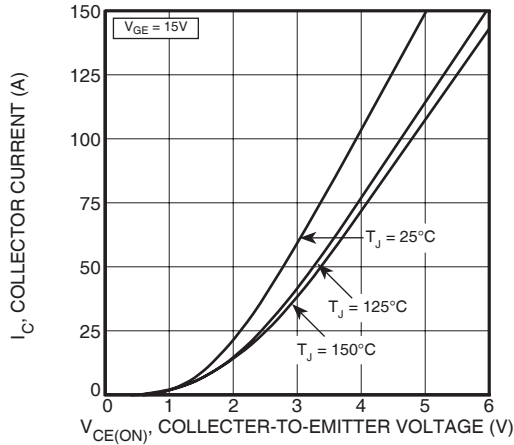

FIGURE 1, Output Characteristics

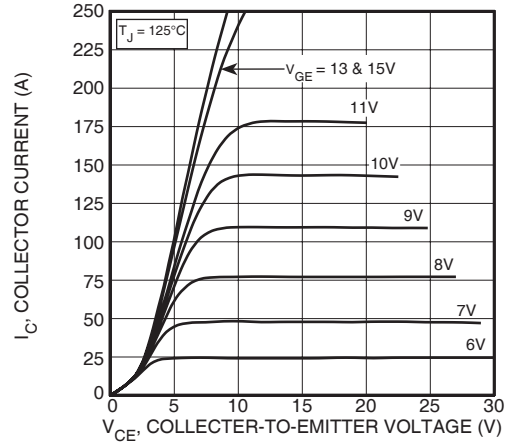

FIGURE 2, Output Characteristics

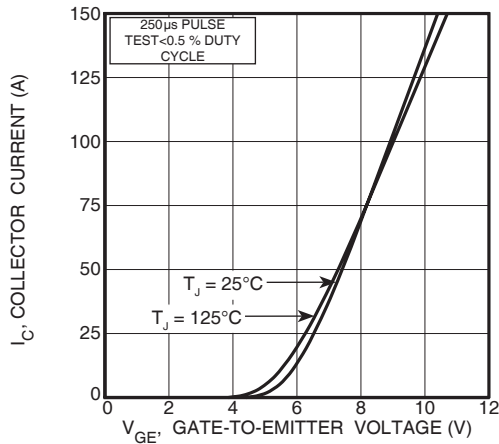

FIGURE 3, Transfer Characteristics

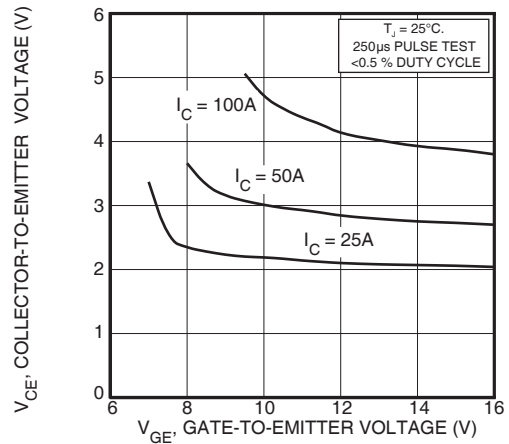

FIGURE 4, On State Voltage vs Gate-to-Emitter Voltage

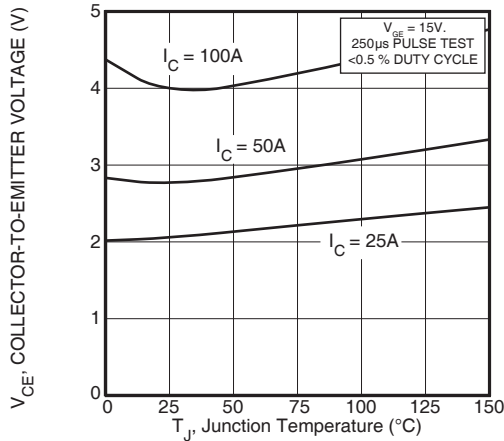

FIGURE 5, On State Voltage vs Junction Temperature

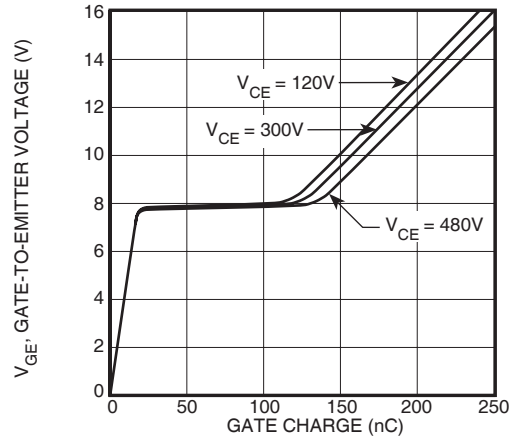

FIGURE 6, Gate Charge

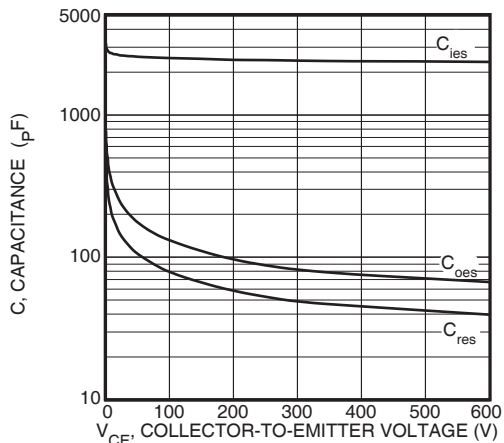

FIGURE 7, Capacitance vs Collector-To-Emitter Voltage

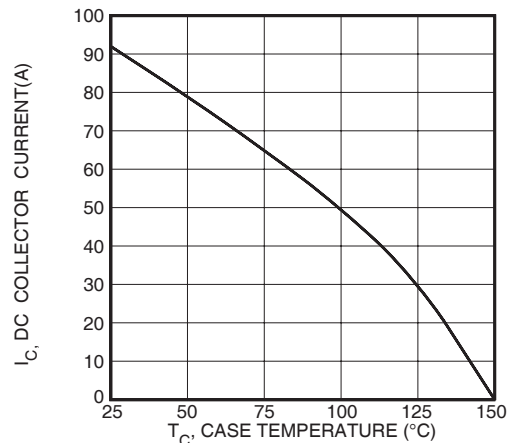

FIGURE 8, DC Collector Current vs Case Temperature

$I_C = 25A$   
 $T_J = 25^\circ C$

# TYPICAL PERFORMANCE CURVES

APT50GS60B\_SRDQ2(G)

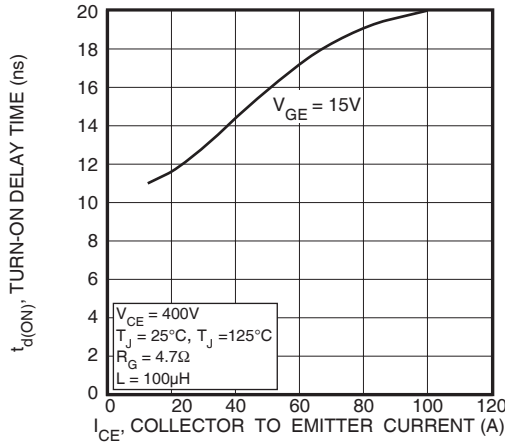

FIGURE 9, Turn-On Delay Time vs Collector Current

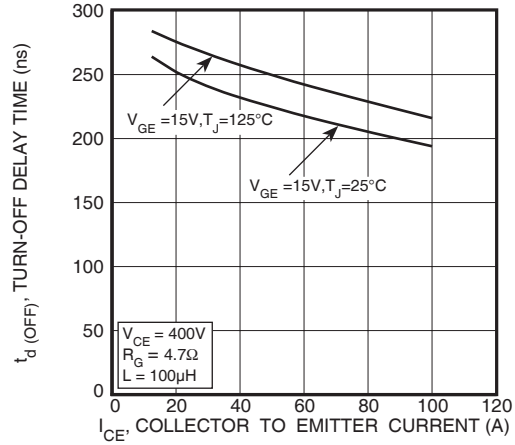

FIGURE 10, Turn-Off Delay Time vs Collector Current

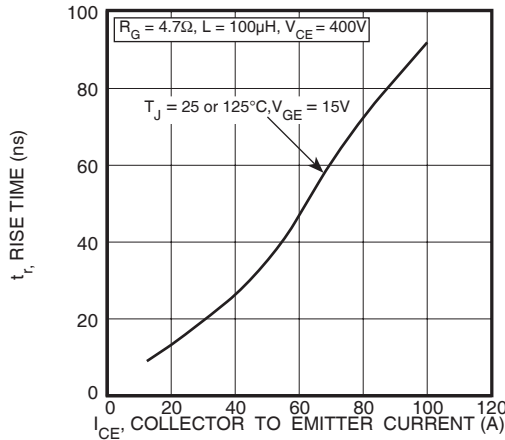

FIGURE 11, Current Rise Time vs Collector Current

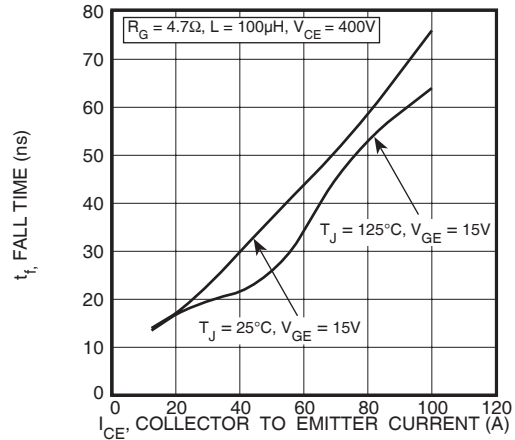

FIGURE 12, Current Fall Time vs Collector Current

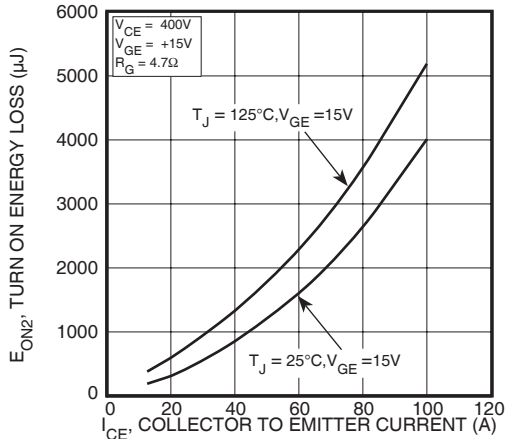

FIGURE 13, Turn-On Energy Loss vs Collector Current

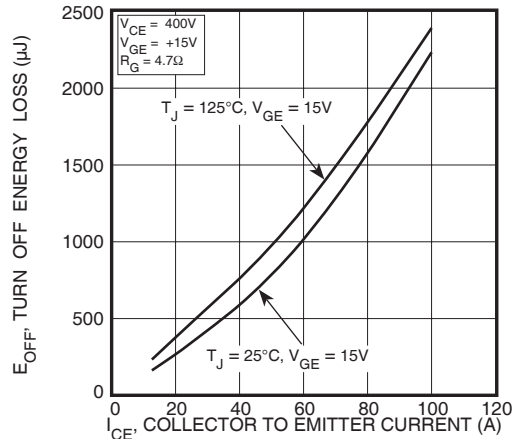

FIGURE 14, Turn Off Energy Loss vs Collector Current

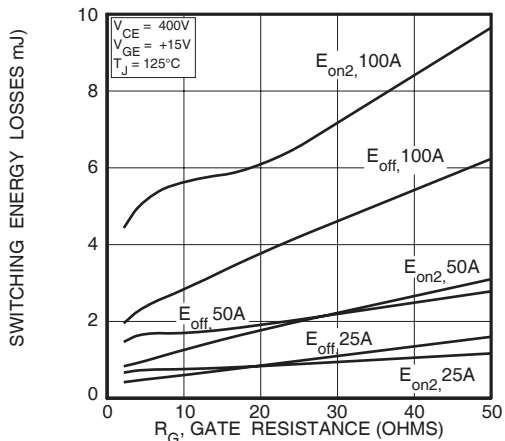

FIGURE 15, Switching Energy Losses vs. Gate Resistance

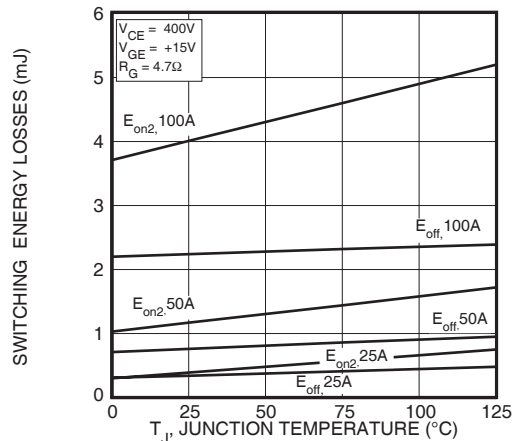

FIGURE 16, Switching Energy Losses vs Junction Temperature

TYPICAL PERFORMANCE CURVES

APT50GS60B\_SRDQ2(G)

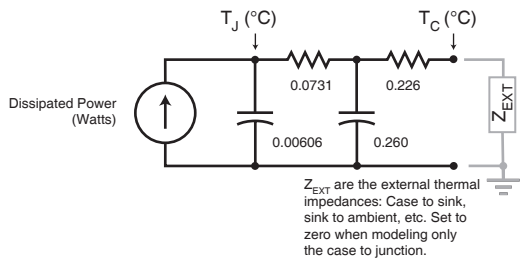
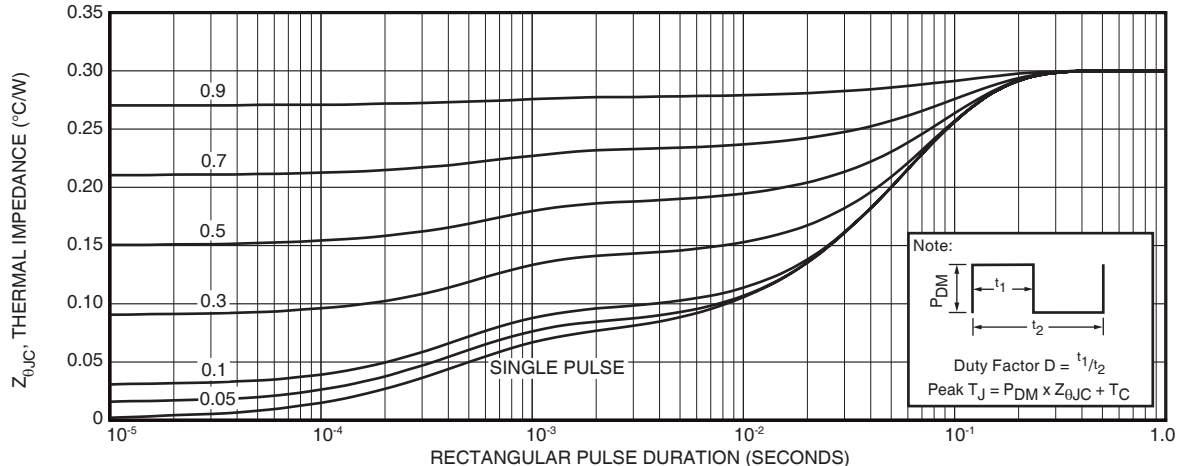
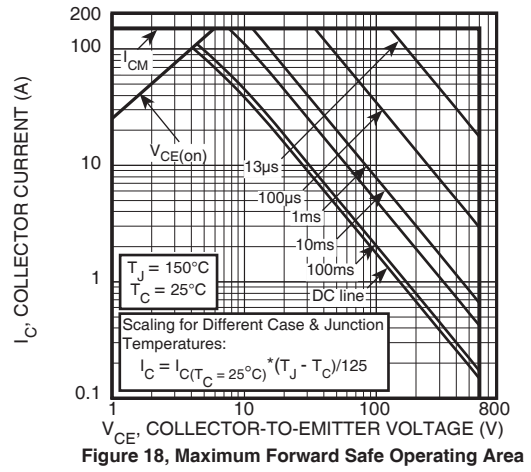
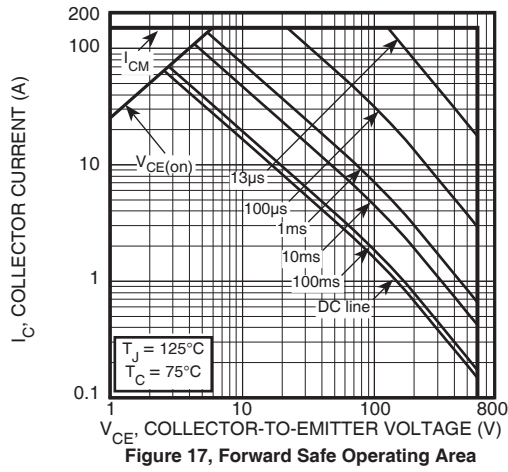
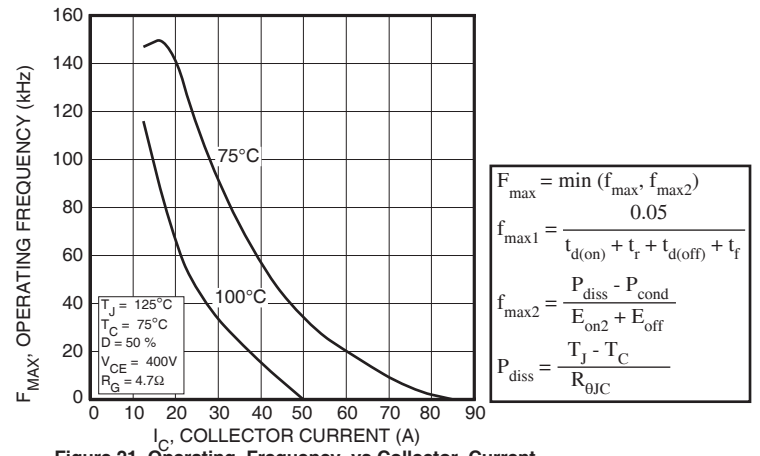

Figure 20, Transient Thermal Impedance Model



$$F_{max} = \min(f_{max1}, f_{max2})$$

$$f_{max1} = \frac{0.05}{t_{d(on)} + t_r + t_{d(off)} + t_f}$$

$$f_{max2} = \frac{P_{diss} - P_{cond}}{E_{on2} + E_{off}}$$

$$P_{diss} = \frac{T_J - T_C}{R_{\theta JC}}$$

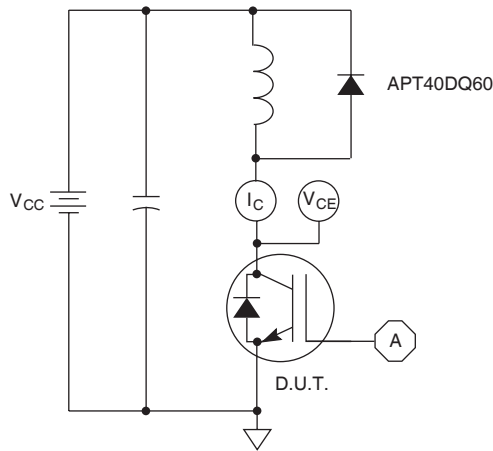

Figure 22, Inductive Switching Test Circuit

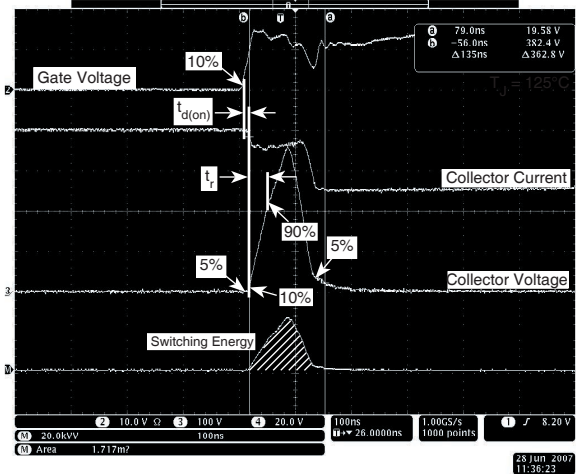

Figure 23, Turn-on Switching Waveforms and Definitions

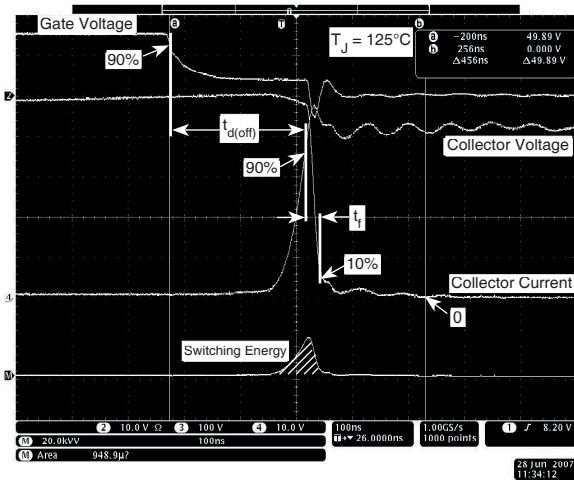

Figure 24, Turn-off Switching Waveforms and Definitions

FOOT NOTE:

- ① Repetitive Rating: Pulse width and case temperature limited by maximum junction temperature.
- ② Starting at  $T_J = 25^\circ\text{C}$ ,  $L = 224\mu\text{H}$ ,  $R_G = 25\Omega$ ,  $I_C = 50\text{A}$
- ③ Short circuit time:  $V_{GE} = 15\text{V}$ ,  $V_{CC} \leq 600\text{V}$ ,  $T_J \leq 150^\circ\text{C}$
- ④ Pulse test: Pulse width <  $380\mu\text{s}$ , duty cycle < 2%
- ⑤  $C_{o(cr)}$  is defined as a fixed capacitance with the same stored charge as  $C_{oes}$  with  $V_{CE} = 67\%$  of  $V_{(BR)CES}$ .
- ⑥  $C_{o(er)}$  is defined as a fixed capacitance with the same stored energy as  $C_{oes}$  with  $V_{CE} = 67\%$  of  $V_{(BR)CES}$ . To calculate  $C_{o(er)}$  for any value of  $V_{CE}$  less than  $V_{(BR)CES}$ , use this equation:  $C_{o(er)} = 5.57E-8/V_{DS}^2 + 7.15E-8/V_{DS} + 2.75E-10$ .
- ⑦  $R_G$  is external gate resistance, not including internal gate resistance or gate driver impedance (MIC4452).
- ⑧  $E_{on1}$  is the inductive turn-on energy of the IGBT only, without the effect of a commutating diode reverse recovery current adding to the IGBT turn-on switching loss. It is measured by clamping the inductance with a Silicon Carbide Schottky diode.
- ⑨  $E_{on2}$  is the inductive turn-on energy that includes a commutating diode reverse recovery current in the IGBT turn-on energy.
- ⑩  $E_{off}$  is the clamped inductive turn-off energy measured in accordance with JEDEC standard JESD24-1.

Microsemi reserves the right to change, without notice, the specifications and information contained herein.

**TO-247 Package Outline**

ⓔ1 SAC: Tin, Silver, Copper

**D<sup>3</sup> Pak Package Outline**

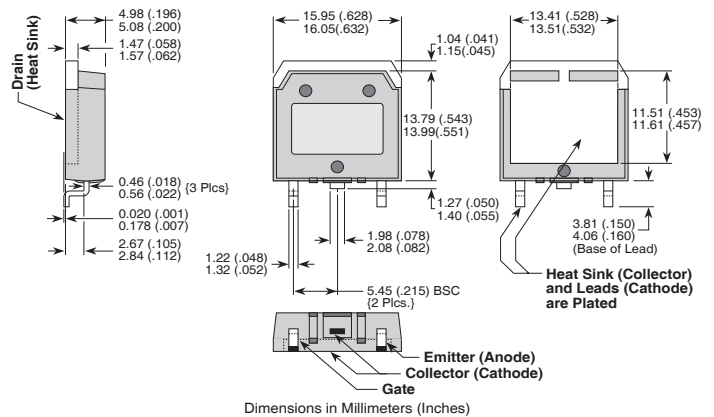
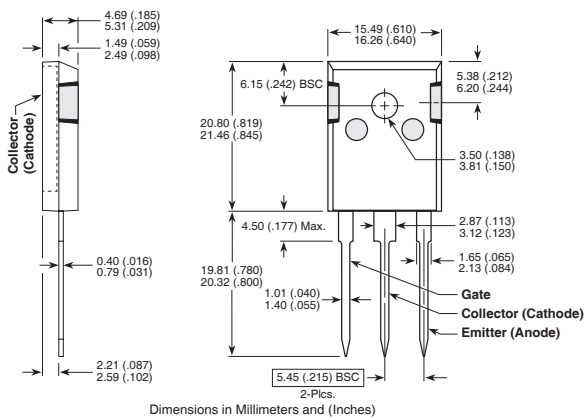

Microsemi's products are covered by one or more of U.S. patents 4,895,810 5,045,903 5,089,434 5,182,234 5,019,522 5,262,336 6,503,786 5,256,583 4,748,103 5,283,202 5,231,474 5,434,095 5,528,058 and foreign patents. US and Foreign patents pending. All Rights Reserved.