

## POWER MOS 7® IGBT

The POWER MOS 7® IGBT is a new generation of high voltage power IGBTs. Using Punch Through Technology this IGBT is ideal for many high frequency, high voltage switching applications and has been optimized for high frequency switchmode power supplies.

- Low Conduction Loss
- Low Gate Charge
- Ultrafast Tail Current shutoff
- SSOA Rated

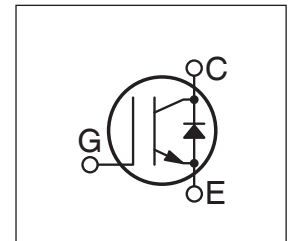

### MAXIMUM RATINGS

All Ratings:  $T_C = 25^\circ\text{C}$  unless otherwise specified.

Symbol	Parameter	APT50GP60JDQ2	UNIT
$V_{CES}$	Collector-Emitter Voltage	600	Volts
$V_{GE}$	Gate-Emitter Voltage	$\pm 30$	
$I_{C1}$	Continuous Collector Current @ $T_C = 25^\circ\text{C}$	100	Amps
$I_{C2}$	Continuous Collector Current @ $T_C = 110^\circ\text{C}$	46	
$I_{CM}$	Pulsed Collector Current <sup>①</sup>	190	
SSOA	Switching Safe Operating Area @ $T_J = 150^\circ\text{C}$	190A @ 600V	
$P_D$	Total Power Dissipation	329	Watts
$T_J, T_{STG}$	Operating and Storage Junction Temperature Range	-55 to 150	$^\circ\text{C}$
$T_L$	Max. Lead Temp. for Soldering: 0.063" from Case for 10 Sec.	300	

### STATIC ELECTRICAL CHARACTERISTICS

Symbol	Characteristic / Test Conditions	MIN	TYP	MAX	Units
$V_{(BR)CES}$	Collector-Emitter Breakdown Voltage ( $V_{GE} = 0\text{V}, I_C = 525\mu\text{A}$ )	600			Volts
$V_{GE(TH)}$	Gate Threshold Voltage ( $V_{CE} = V_{GE}, I_C = 1\text{mA}, T_J = 25^\circ\text{C}$ )	3	4.5	6	
$V_{CE(ON)}$	Collector-Emitter On Voltage ( $V_{GE} = 15\text{V}, I_C = 50\text{A}, T_J = 25^\circ\text{C}$ )		2.2	2.7	
	Collector-Emitter On Voltage ( $V_{GE} = 15\text{V}, I_C = 50\text{A}, T_J = 125^\circ\text{C}$ )		2.1		
$I_{CES}$	Collector Cut-off Current ( $V_{CE} = 600\text{V}, V_{GE} = 0\text{V}, T_J = 25^\circ\text{C}$ ) <sup>②</sup>			525	$\mu\text{A}$
	Collector Cut-off Current ( $V_{CE} = 600\text{V}, V_{GE} = 0\text{V}, T_J = 125^\circ\text{C}$ ) <sup>②</sup>			3000	
$I_{GES}$	Gate-Emitter Leakage Current ( $V_{GE} = \pm 20\text{V}$ )			$\pm 100$	nA

 **CAUTION:** These Devices are Sensitive to Electrostatic Discharge. Proper Handling Procedures Should Be Followed.

## DYNAMIC CHARACTERISTICS

APT50GP60JDQ2

Symbol	Characteristic	Test Conditions	MIN	TYP	MAX	UNIT	
$C_{ies}$	Input Capacitance	<b>Capacitance</b> $V_{GE} = 0V, V_{CE} = 25V$ $f = 1 \text{ MHz}$		5700		pF	
$C_{oes}$	Output Capacitance			465			
$C_{res}$	Reverse Transfer Capacitance			30			
$V_{GEP}$	Gate-to-Emitter Plateau Voltage	Gate Charge		7.5		V	
$Q_g$	Total Gate Charge <sup>③</sup>	$V_{GE} = 15V$		165		nC	
$Q_{ge}$	Gate-Emitter Charge	$V_{CE} = 300V$		40			
$Q_{gc}$	Gate-Collector ("Miller") Charge	$I_C = 50A$		50			
SSOA	Switching Safe Operating Area	$T_J = 150^\circ C, R_G = 4.3\Omega, V_{GE} = 15V, L = 100\mu H, V_{CE} = 600V$	190			A	
$t_{d(on)}$	Turn-on Delay Time	<b>Inductive Switching (25°C)</b> $V_{CC} = 400V$ $V_{GE} = 15V$ $I_C = 50A$ $R_G = 4.3\Omega$ $T_J = +25^\circ C$		19		ns	
$t_r$	Current Rise Time			36			
$t_{d(off)}$	Turn-off Delay Time			85			
$t_f$	Current Fall Time			60			
$E_{on1}$	Turn-on Switching Energy <sup>④</sup>				465		μJ
$E_{on2}$	Turn-on Switching Energy (Diode) <sup>⑤</sup>				835		
$E_{off}$	Turn-off Switching Energy <sup>⑥</sup>			635			
$t_{d(on)}$	Turn-on Delay Time	<b>Inductive Switching (125°C)</b> $V_{CC} = 400V$ $V_{GE} = 15V$ $I_C = 50A$ $R_G = 4.3\Omega$ $T_J = +125^\circ C$		19		ns	
$t_r$	Current Rise Time			36			
$t_{d(off)}$	Turn-off Delay Time			115			
$t_f$	Current Fall Time			85			
$E_{on1}$	Turn-on Switching Energy <sup>④</sup>				465		μJ
$E_{on2}$	Turn-on Switching Energy (Diode) <sup>⑤</sup>				1260		
$E_{off}$	Turn-off Switching Energy <sup>⑥</sup>			1060			

## THERMAL AND MECHANICAL CHARACTERISTICS

Symbol	Characteristic	MIN	TYP	MAX	UNIT
$R_{\theta JC}$	Junction to Case (IGBT)			.38	°C/W
$R_{\theta JC}$	Junction to Case (DIODE)			1.21	
$W_T$	Package Weight		29.2		gm
$V_{Isolation}$	RMS Voltage (50-60Hz Sinusoidal Waveform From Terminals to Mounting Base for 1 Min.)	2500			Volts

- ① Repetitive Rating: Pulse width limited by maximum junction temperature.
- ② For Combi devices,  $I_{ces}$  includes both IGBT and FRED leakages
- ③ See MIL-STD-750 Method 3471.
- ④  $E_{on1}$  is the clamped inductive turn-on-energy of the IGBT only, without the effect of a commutating diode reverse recovery current adding to the IGBT turn-on loss. (See Figure 24.)
- ⑤  $E_{on2}$  is the clamped inductive turn-on energy that includes a commutating diode reverse recovery current in the IGBT turn-on switching loss. (See Figures 21, 22.)
- ⑥  $E_{off}$  is the clamped inductive turn-off energy measured in accordance with JEDEC standard JESD24-1. (See Figures 21, 23.)

APT Reserves the right to change, without notice, the specifications and information contained herein.

**TYPICAL PERFORMANCE CURVES**

**APT50GP60JDQ2**

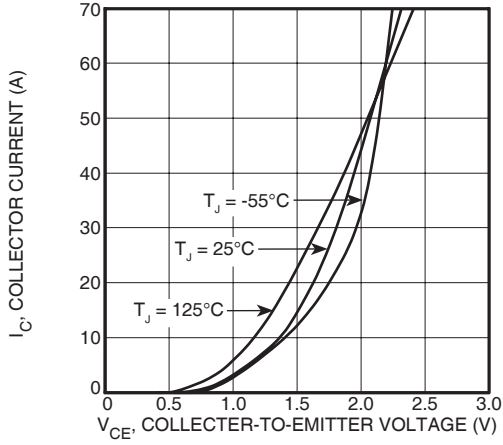

**FIGURE 1, Output Characteristics(T<sub>J</sub> = 25°C)**

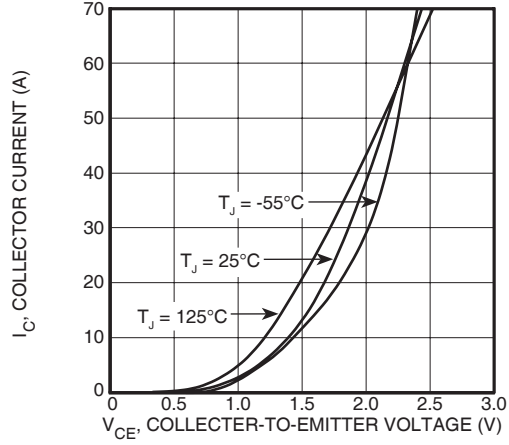

**FIGURE 2, Output Characteristics (T<sub>J</sub> = 125°C)**

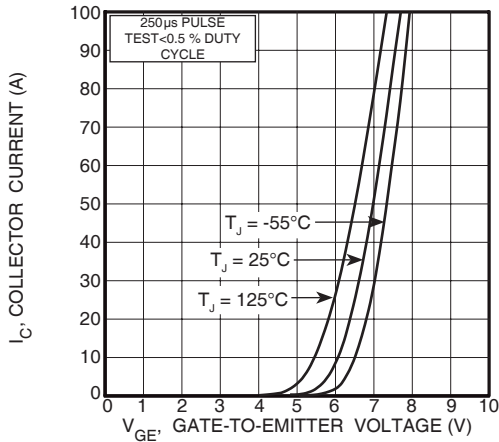

**FIGURE 3, Transfer Characteristics**

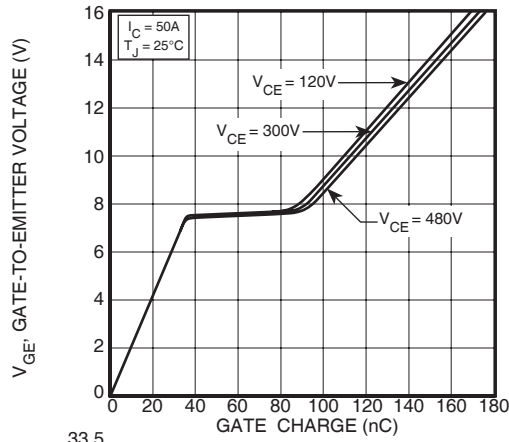

**FIGURE 4, Gate Charge**

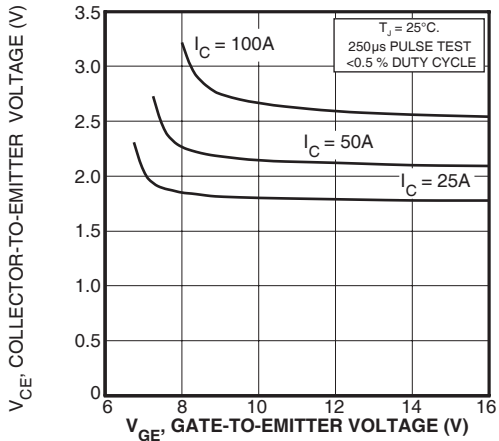

**FIGURE 5, On State Voltage vs Gate-to- Emitter Voltage**

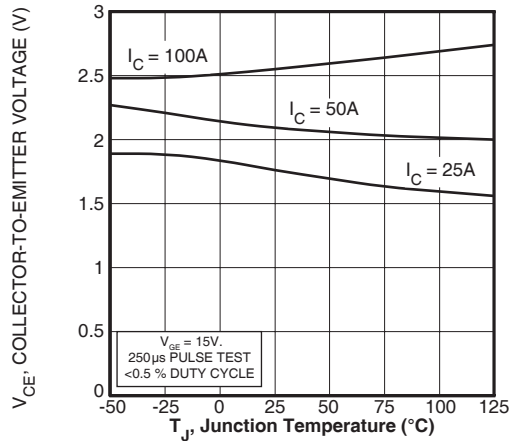

**FIGURE 6, On State Voltage vs Junction Temperature**

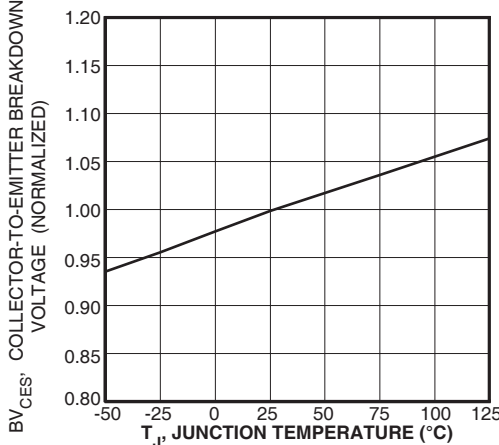

**FIGURE 7, Breakdown Voltage vs. Junction Temperature**

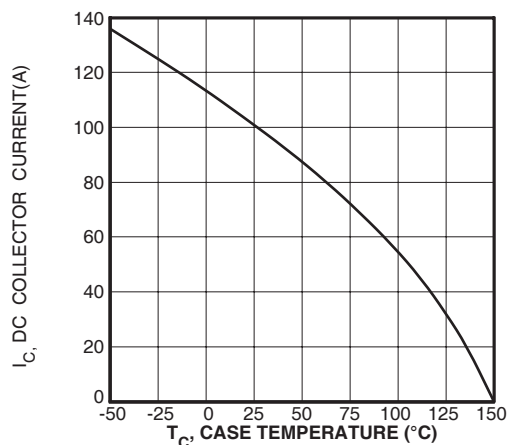

**FIGURE 8, DC Collector Current vs Case Temperature**

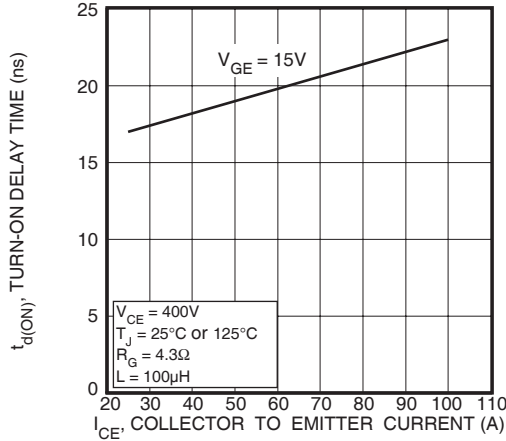

FIGURE 9, Turn-On Delay Time vs Collector Current

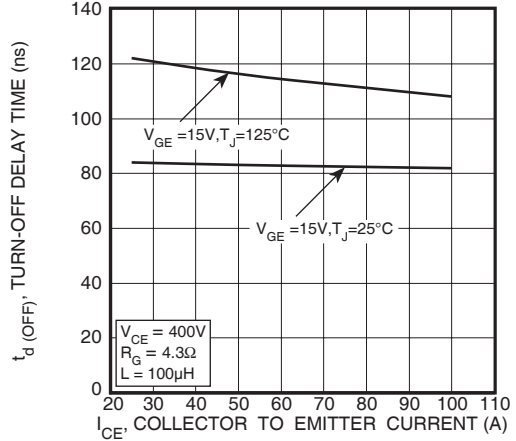

FIGURE 10, Turn-Off Delay Time vs Collector Current

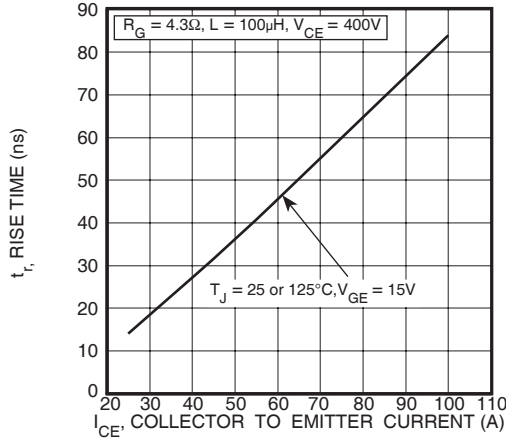

FIGURE 11, Current Rise Time vs Collector Current

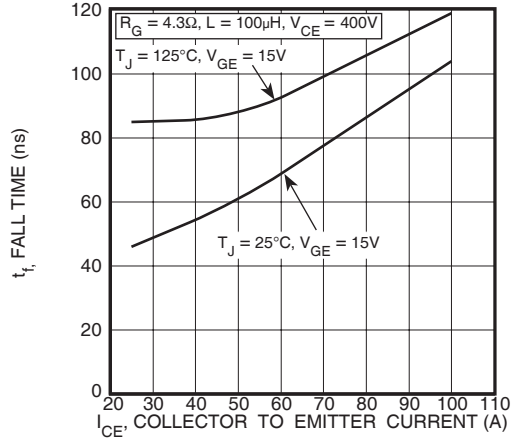

FIGURE 12, Current Fall Time vs Collector Current

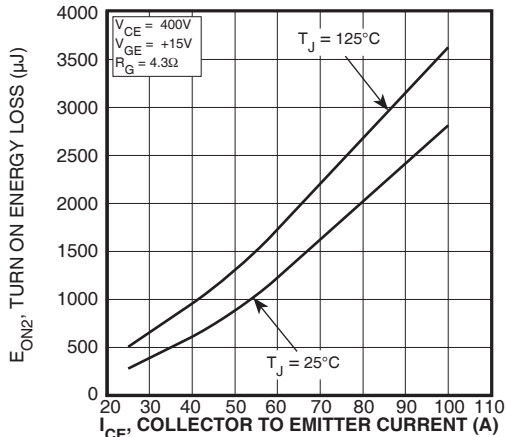

FIGURE 13, Turn-On Energy Loss vs Collector Current

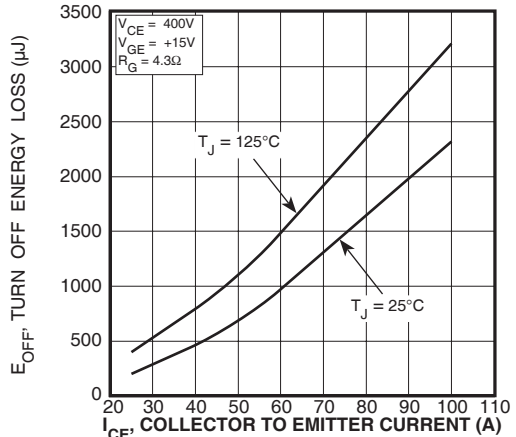

FIGURE 14, Turn Off Energy Loss vs Collector Current

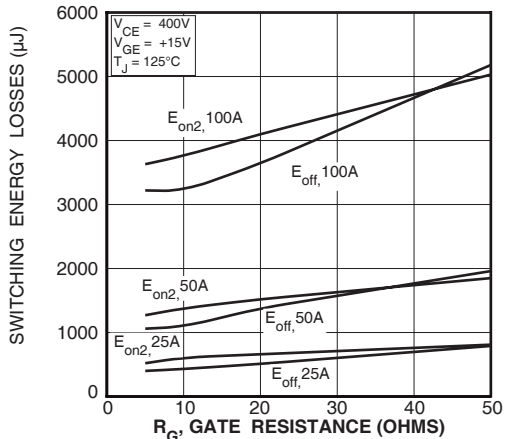

FIGURE 15, Switching Energy Losses vs. Gate Resistance

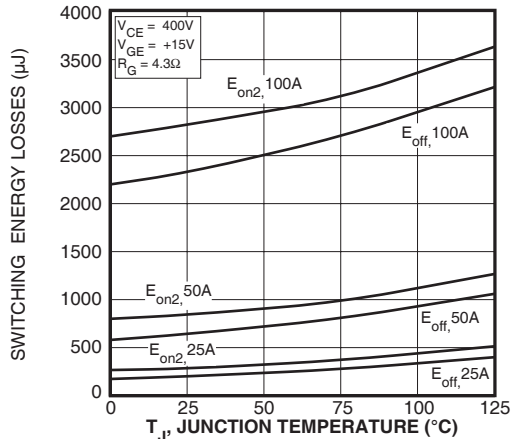

FIGURE 16, Switching Energy Losses vs Junction Temperature

# TYPICAL PERFORMANCE CURVES

APT50GP60JDQ2

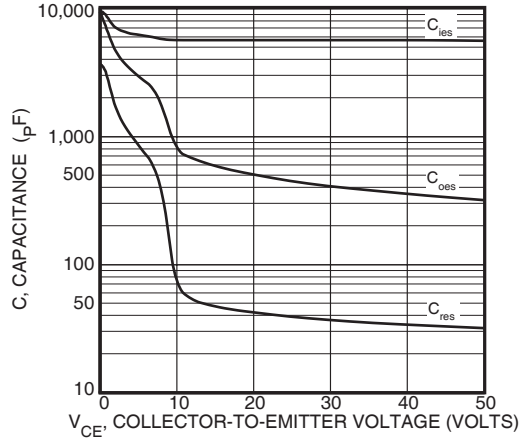

Figure 17, Capacitance vs Collector-To-Emitter Voltage

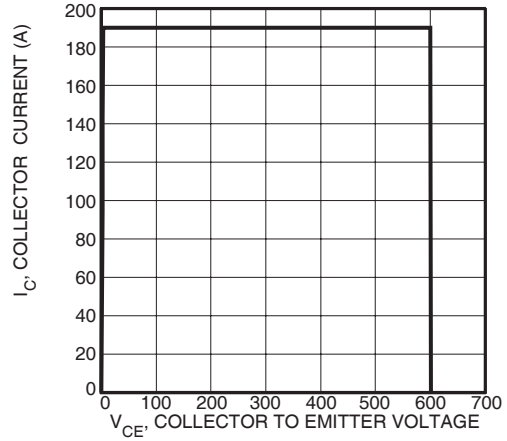

Figure 18, Minimum Switching Safe Operating Area

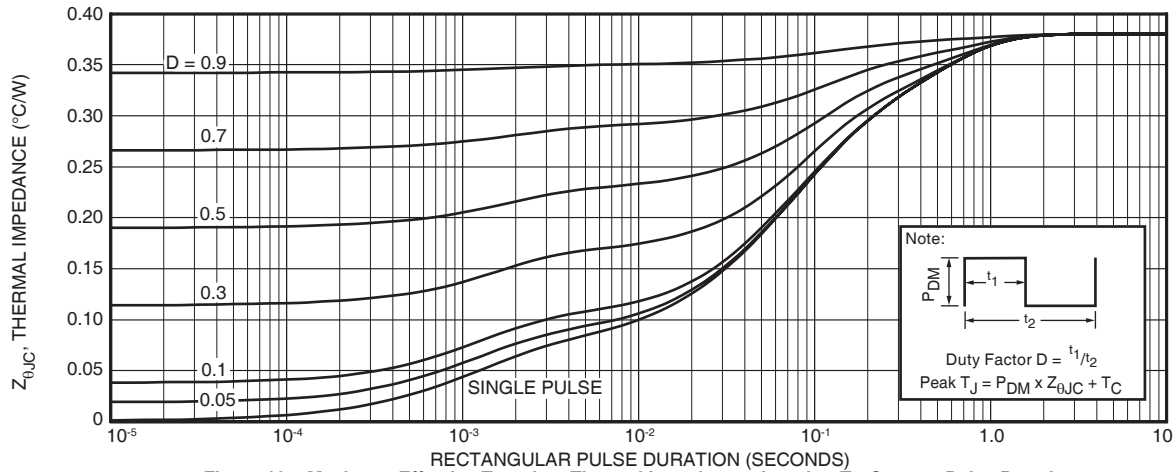

Figure 19a, Maximum Effective Transient Thermal Impedance, Junction-To-Case vs Pulse Duration

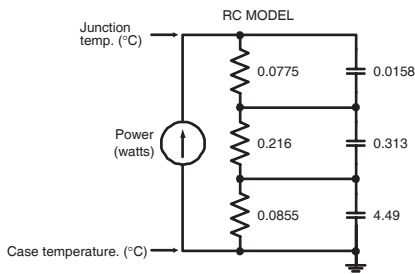

FIGURE 19b, TRANSIENT THERMAL IMPEDANCE MODEL

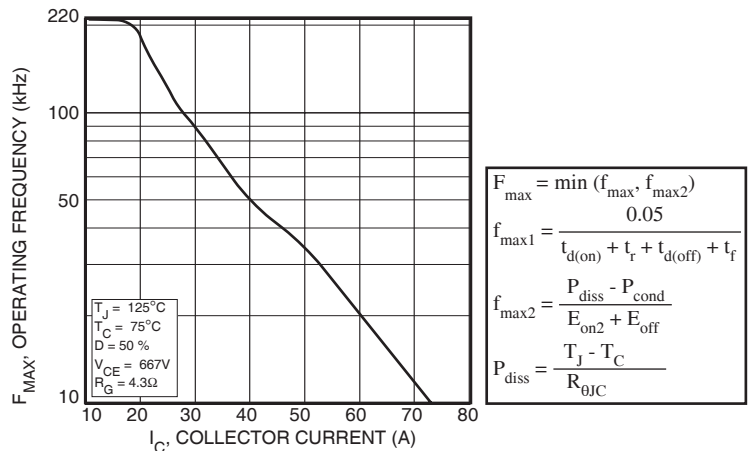

Figure 20, Operating Frequency vs Collector Current

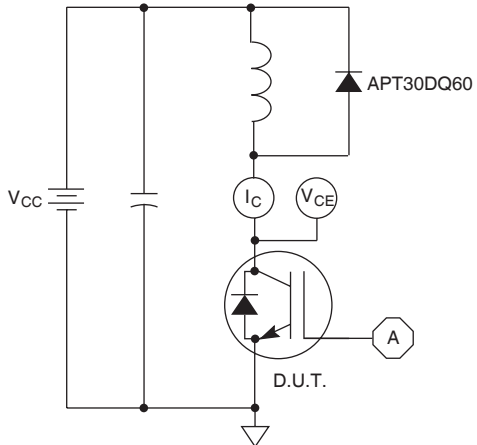

Figure 21, Inductive Switching Test Circuit

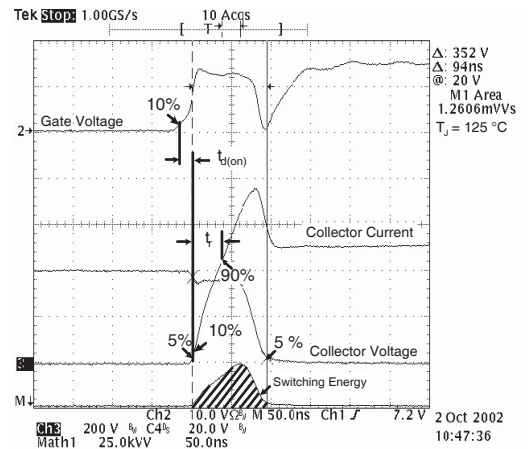

Figure 22, Turn-on Switching Waveforms and Definitions

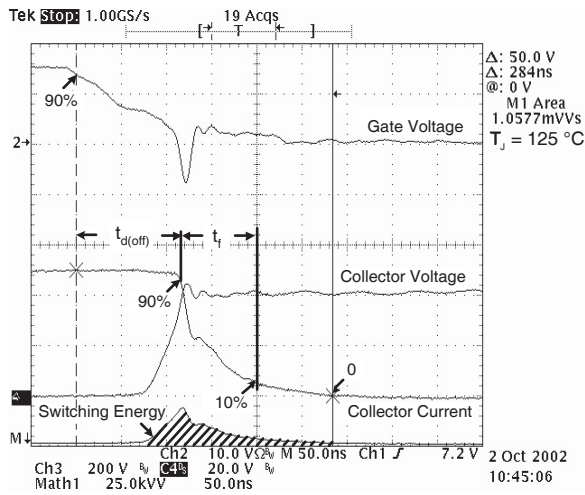

Figure 23, Turn-off Switching Waveforms and Definitions

# ULTRAFAST SOFT RECOVERY ANTI-PARALLEL DIODE

**MAXIMUM RATINGS**

All Ratings:  $T_C = 25^\circ\text{C}$  unless otherwise specified.

Symbol	Characteristic / Test Conditions	APT50GP60JDQ2		UNIT
$I_F(\text{AV})$	Maximum Average Forward Current ( $T_C = 100^\circ\text{C}$ , Duty Cycle = 0.5)		30	Amps
$I_F(\text{RMS})$	RMS Forward Current (Square wave, 50% duty)		42	
$I_{\text{FSM}}$	Non-Repetitive Forward Surge Current ( $T_J = 45^\circ\text{C}$ , 8.3ms)		320	

**STATIC ELECTRICAL CHARACTERISTICS**

Symbol	Characteristic / Test Conditions	MIN	TYP	MAX	UNIT
$V_F$	Forward Voltage		$I_F = 50\text{A}$	2.1	Volts
			$I_F = 100\text{A}$	2.6	
			$I_F = 50\text{A}, T_J = 125^\circ\text{C}$	1.75	

**DYNAMIC CHARACTERISTICS**

Symbol	Characteristic	Test Conditions	MIN	TYP	MAX	UNIT
$t_{rr}$	Reverse Recovery Time	$I_F = 1\text{A}, di_F/dt = -100\text{A}/\mu\text{s}, V_R = 30\text{V}, T_J = 25^\circ\text{C}$	-	21		ns
$t_{rr}$	Reverse Recovery Time	$I_F = 30\text{A}, di_F/dt = -200\text{A}/\mu\text{s}, V_R = 400\text{V}, T_C = 25^\circ\text{C}$	-	105		
$Q_{rr}$	Reverse Recovery Charge		-	115		nC
$I_{RRM}$	Maximum Reverse Recovery Current		-	3	-	Amps
$t_{rr}$	Reverse Recovery Time	$I_F = 30\text{A}, di_F/dt = -200\text{A}/\mu\text{s}, V_R = 400\text{V}, T_C = 125^\circ\text{C}$	-	125		ns
$Q_{rr}$	Reverse Recovery Charge		-	465		nC
$I_{RRM}$	Maximum Reverse Recovery Current		-	7	-	Amps
$t_{rr}$	Reverse Recovery Time	$I_F = 30\text{A}, di_F/dt = -1000\text{A}/\mu\text{s}, V_R = 400\text{V}, T_C = 125^\circ\text{C}$	-	60		ns
$Q_{rr}$	Reverse Recovery Charge		-	830		nC
$I_{RRM}$	Maximum Reverse Recovery Current		-	23		Amps

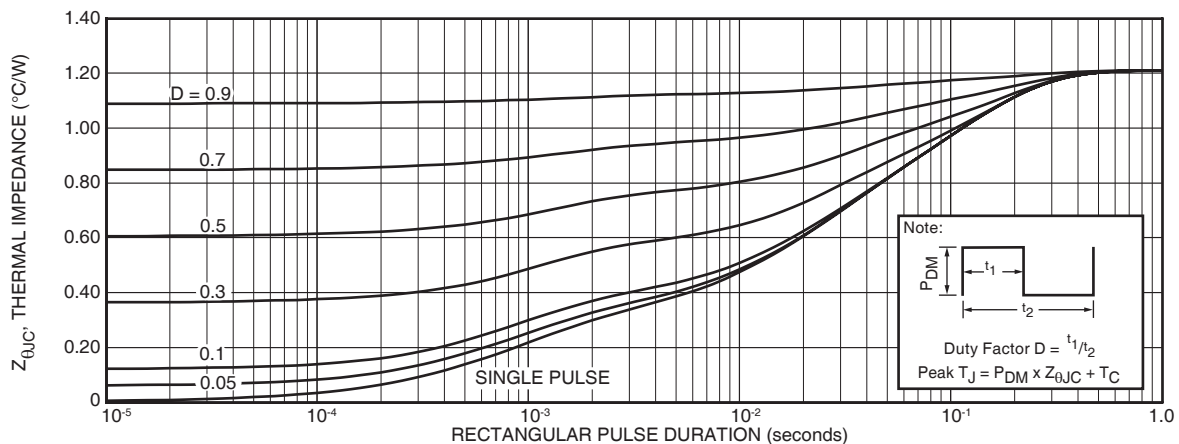

FIGURE 24a. MAXIMUM EFFECTIVE TRANSIENT THERMAL IMPEDANCE, JUNCTION-TO-CASE vs. PULSE DURATION

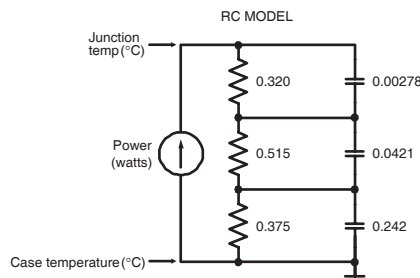

FIGURE 24b. TRANSIENT THERMAL IMPEDANCE MODEL

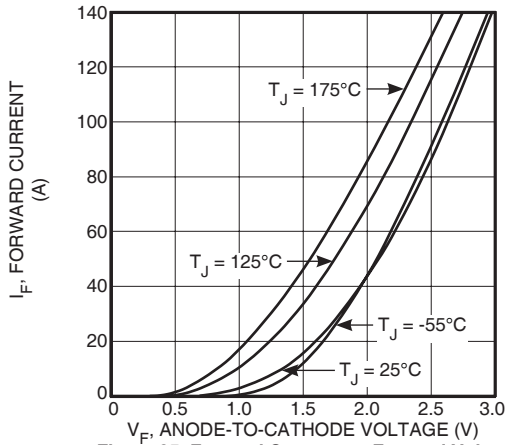

Figure 25. Forward Current vs. Forward Voltage

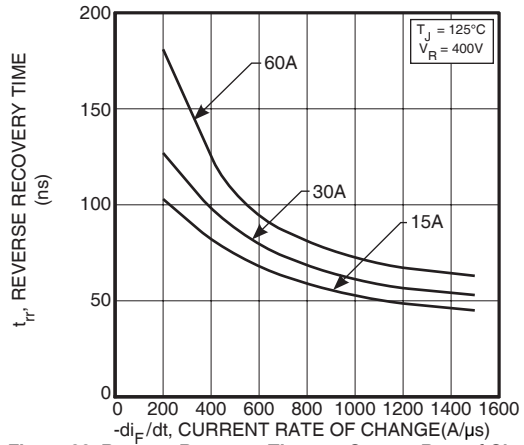

Figure 26. Reverse Recovery Time vs. Current Rate of Change

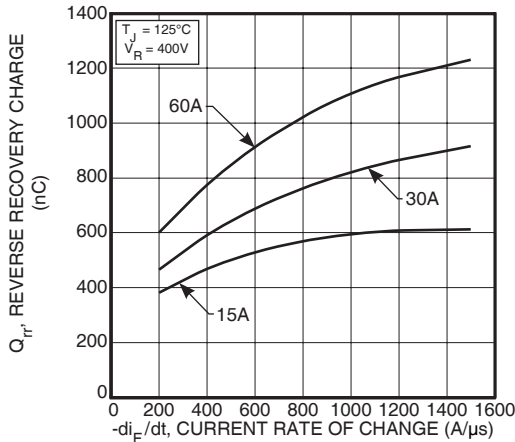

Figure 27. Reverse Recovery Charge vs. Current Rate of Change

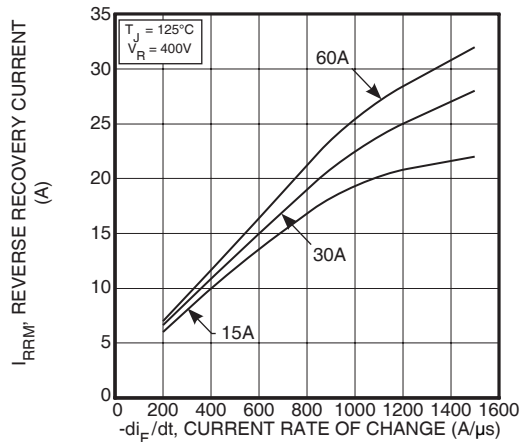

Figure 28. Reverse Recovery Current vs. Current Rate of Change

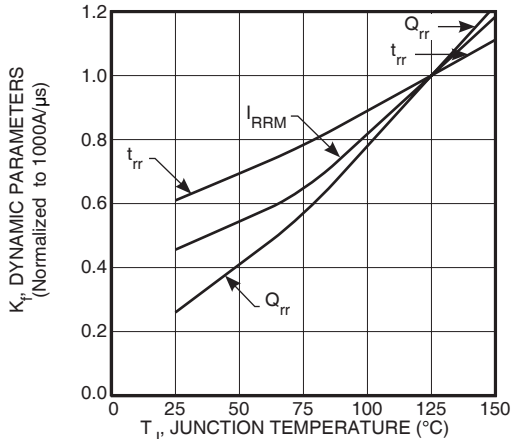

Figure 29. Dynamic Parameters vs. Junction Temperature

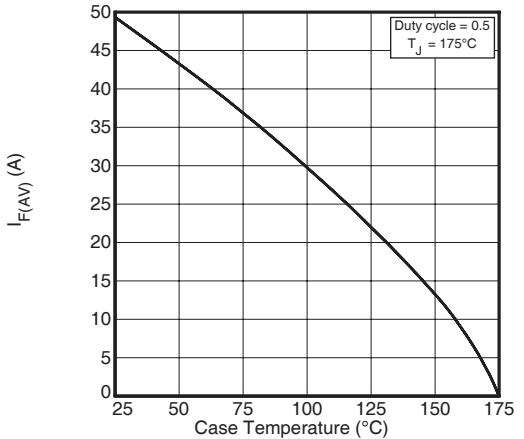

Figure 30. Maximum Average Forward Current vs. Case Temperature

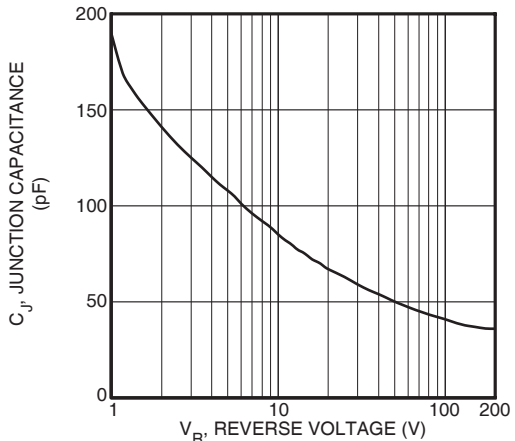

Figure 31. Junction Capacitance vs. Reverse Voltage



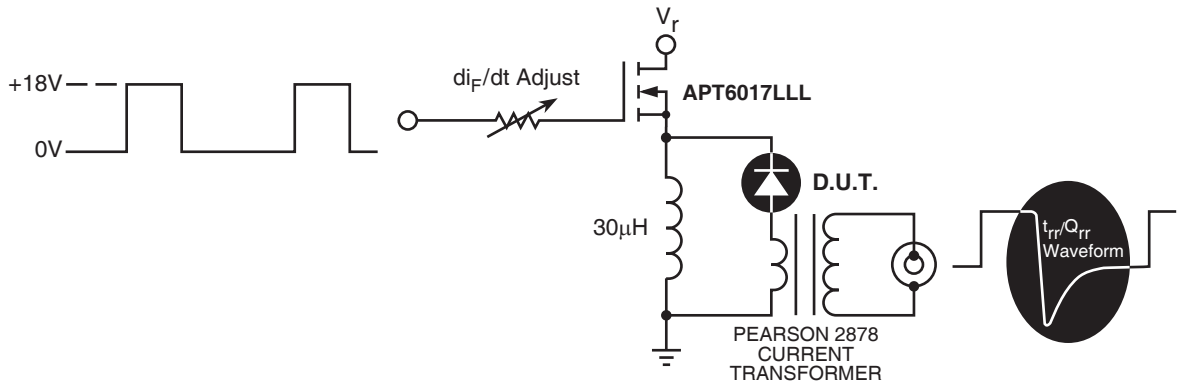

Figure 32. Diode Test Circuit

- 1  $I_F$  - Forward Conduction Current
- 2  $di_F/dt$  - Rate of Diode Current Change Through Zero Crossing.
- 3  $I_{RRM}$  - Maximum Reverse Recovery Current.
- 4  $t_{rr}$  - Reverse Recovery Time, measured from zero crossing where diode current goes from positive to negative, to the point at which the straight line through  $I_{RRM}$  and  $0.25 \cdot I_{RRM}$  passes through zero.
- 5  $Q_{rr}$  - Area Under the Curve Defined by  $I_{RRM}$  and  $t_{rr}$ .

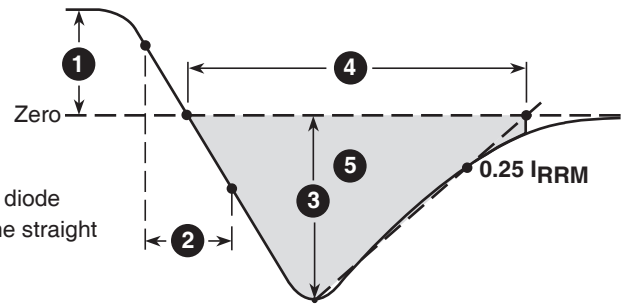
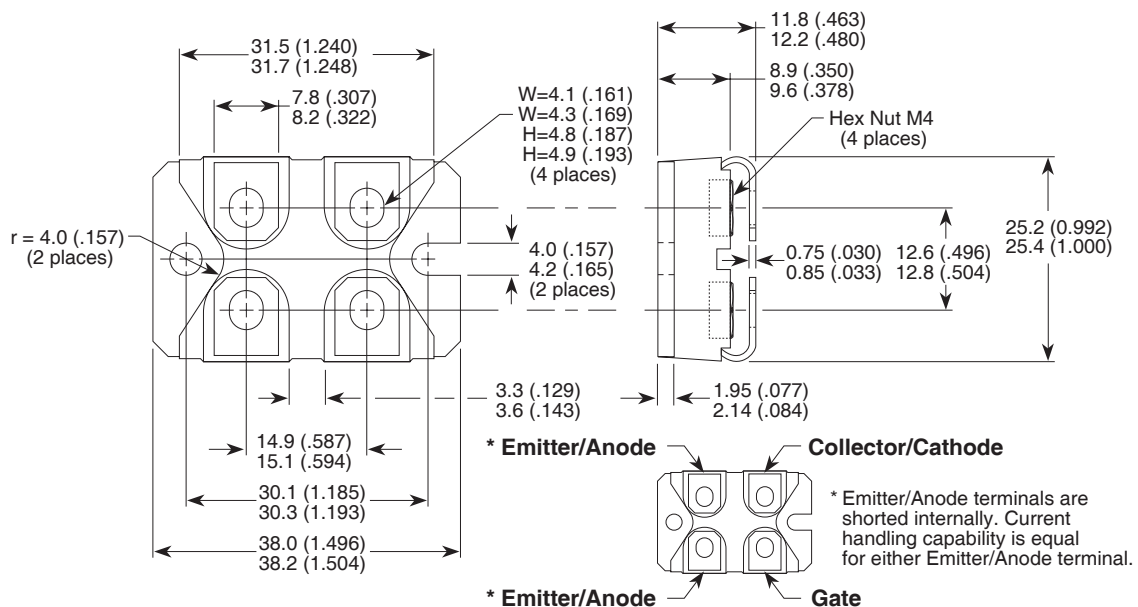

Figure 33. Diode Reverse Recovery Waveform and Definitions

SOT-227 (ISOTOP®) Package Outline



Dimensions in Millimeters and (Inches)