

# Complementary Silicon High-Power Transistors

... designed for general-purpose power amplifier and switching applications.

- Collector-Emitter Sustaining Voltage —  
 $V_{CE(sus)} = 60 \text{ Vdc (Min) — 2N5879, 2N5881}$   
 $= 80 \text{ Vdc (Min) — 2N5880, 2N5882}$
- DC Current Gain —  
 $h_{FE} = 20 \text{ (Min) @ } I_C = 6.0 \text{ Adc}$
- Low Collector — Emitter Saturation Voltage —  
 $V_{CE(sat)} = 1.0 \text{ Vdc (Max) @ } I_C = 7.0 \text{ Adc}$
- High Current — Gain-Bandwidth Product —  
 $f_T = 4.0 \text{ MHz (Min) @ } I_C = 1.0 \text{ Adc}$

## MAXIMUM RATINGS (1)

| Rating   | Symbol         | 2N5879<br>2N5881 | 2N5880<br>2N5882 | Unit                         |
|--|----------------|------------------|------------------|------------------------------|
| Collector-Emitter Voltage  | $V_{CEO}$      | 60               | 80               | Vdc                          |
| Collector-Base Voltage   | $V_{CB}$       | 60               | 80               | Vdc                          |
| Emitter-Base Voltage   | $V_{EB}$       | 5.0              |                  | Vdc                          |
| Collector Current — Continuous<br>Peak   | $I_C$          | 15<br>30         |                  | Adc                          |
| Base Current   | $I_B$          | 5.0              |                  | Adc                          |
| Total Device Dissipation @ $T_C = 25^\circ\text{C}$<br>Derate above $25^\circ\text{C}$ | $P_D$          | 160<br>0.915     |                  | Watts<br>W/ $^\circ\text{C}$ |
| Operating and Storage Junction<br>Temperature Range                                    | $T_J, T_{stg}$ | -65 to +200      |                  | $^\circ\text{C}$             |

## THERMAL CHARACTERISTICS

| Characteristic                       | Symbol        | Max | Unit               |
|--------------------------------------|---------------|-----|--------------------|
| Thermal Resistance, Junction to Case | $\theta_{JC}$ | 1.1 | $^\circ\text{C/W}$ |

(1) Indicates JEDEC registered data. Units and conditions differ on some parameters and re-registration reflecting these changes has been requested. All above values meet or exceed present JEDEC registered data.

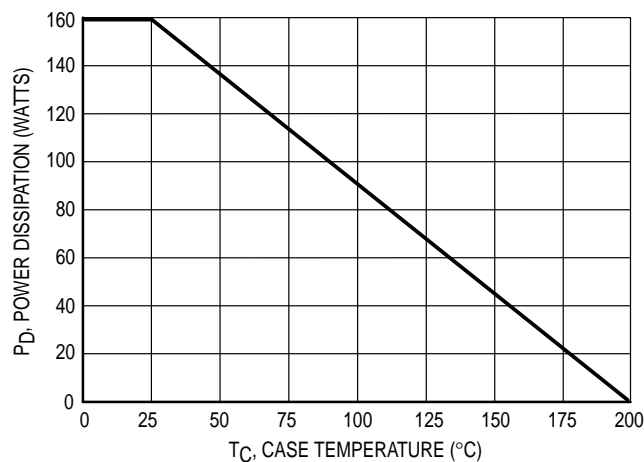

Figure 1. Power Derating

Preferred devices are Motorola recommended choices for future use and best overall value.

REV 7

**PNP**  
**2N5879**  
  
**2N5880\***  
**NPN**  
**2N5881**  
  
**2N5882\***

\*Motorola Preferred Device

**15 AMPERE**  
**COMPLEMENTARY**  
**SILICON**  
**POWER TRANSISTORS**  
**60-80 VOLTS**  
**160 WATTS**

**CASE 1-07**  
**TO-204AA**  
**(TO-3)**

**2N5879 2N5880 2N5881 2N5882**

\*ELECTRICAL CHARACTERISTICS ( $T_C = 25^\circ\text{C}$  unless otherwise noted)

| Characteristic   | Symbol   | Min            | Max              | Unit                     |      |
|--|--|----------------|------------------|--------------------------|------|
| <b>OFF CHARACTERISTICS</b>   |  |                |                  |                          |      |
| Collector–Emitter Sustaining Voltage (1)<br>( $I_C = 200\text{ mAdc}$ , $I_B = 0$ )  | 2N5879, 2N5881<br>2N5880, 2N5882                                     | $V_{CEO(sus)}$ | 60<br>80         | —<br>—                   | Vdc  |
| Collector Cutoff Current<br>( $V_{CE} = 30\text{ Vdc}$ , $I_B = 0$ )<br>( $V_{CE} = 40\text{ Vdc}$ , $I_B = 0$ )   | 2N5879, 2N5881<br>2N5880, 2N5882                                     | $I_{CEO}$      | —<br>—           | 1.0<br>1.0               | mAdc |
| Collector Cutoff Current<br>( $V_{CE} = 60\text{ Vdc}$ , $V_{BE(off)} = 1.5\text{ Vdc}$ )<br>( $V_{CE} = 80\text{ Vdc}$ , $V_{BE(off)} = 1.5\text{ Vdc}$ )<br>( $V_{CE} = 60\text{ Vdc}$ , $V_{BE(off)} = 1.5\text{ Vdc}$ , $T_C = 150^\circ\text{C}$ )<br>( $V_{CE} = 80\text{ Vdc}$ , $V_{BE(off)} = 1.5\text{ Vdc}$ , $T_C = 150^\circ\text{C}$ ) | 2N5879, 2N5881<br>2N5880, 2N5882<br>2N5879, 2N5881<br>2N5880, 2N5882 | $I_{CEX}$      | —<br>—<br>—<br>— | 0.5<br>0.5<br>5.0<br>5.0 | mAdc |
| Collector Cutoff Current<br>( $V_{CB} = 60\text{ Vdc}$ , $I_E = 0$ )<br>( $V_{CB} = 80\text{ Vdc}$ , $I_E = 0$ )   | 2N5879, 2N5881<br>2N5880, 2N5882                                     | $I_{CBO}$      | —<br>—           | 0.5<br>0.5               | mAdc |
| Emitter Cutoff Current ( $V_{EB} = 5.0\text{ Vdc}$ , $I_C = 0$ )   |  | $I_{EBO}$      | —                | 1.0                      | mAdc |

**ON CHARACTERISTICS**

|  |               |                 |               |     |
|--|---------------|-----------------|---------------|-----|
| DC Current Gain (1)<br>( $I_C = 2.0\text{ Adc}$ , $V_{CE} = 4.0\text{ Vdc}$ )<br>( $I_C = 6.0\text{ Adc}$ , $V_{CE} = 4.0\text{ Vdc}$ )<br>( $I_C = 15\text{ Adc}$ , $V_{CE} = 4.0\text{ Vdc}$ ) | $h_{FE}$      | 35<br>20<br>4.0 | —<br>100<br>— | —   |
| Collector–Emitter Saturation Voltage (1)<br>( $I_C = 7.0\text{ Adc}$ , $I_B = 0.7\text{ Adc}$ )<br>( $I_C = 15\text{ Adc}$ , $I_B = 3.75\text{ Adc}$ )   | $V_{CE(sat)}$ | —<br>—          | 1.0<br>4.0    | Vdc |
| Base–Emitter Saturation Voltage (1) ( $I_C = 15\text{ Adc}$ , $I_B = 3.75\text{ Adc}$ )  | $V_{BE(sat)}$ | —               | 2.5           | Vdc |
| Base–Emitter On Voltage (1) ( $I_C = 6.0\text{ Adc}$ , $V_{CE} = 4.0\text{ Vdc}$ )   | $V_{BE(on)}$  | —               | 1.5           | Vdc |

**DYNAMIC CHARACTERISTICS**

|   |                                  |          |        |            |    |
|---|----------------------------------|----------|--------|------------|----|
| Current–Gain — Bandwidth Product (2)<br>( $I_C = 1.0\text{ Adc}$ , $V_{CE} = 10\text{ Vdc}$ , $f_{test} = 1.0\text{ MHz}$ ) | $f_T$                            | 4.0      | —      | MHz        |    |
| Output Capacitance<br>( $V_{CB} = 10\text{ Vdc}$ , $I_E = 0$ , $f = 100\text{ kHz}$ )                                       | 2N5879, 2N5880<br>2N5881, 2N5882 | $C_{ob}$ | —<br>— | 600<br>400 | pF |
| Small–Signal Current Gain ( $I_C = 2.0\text{ Adc}$ , $V_{CE} = 4.0\text{ Vdc}$ , $f = 1.0\text{ kHz}$ )                     | $h_{fe}$                         | 20       | —      | —          |    |

**SWITCHING CHARACTERISTICS**

|              |  |       |   |     |               |
|--------------|--|-------|---|-----|---------------|
| Rise Time    | $(V_{CC} = 30\text{ Vdc}$ , $I_C = 6.0\text{ Adc}$ ,<br>$I_{B1} = I_{B2} = 0.6\text{ Adc}$ See Figure 2) | $t_r$ | — | 0.7 | $\mu\text{s}$ |
| Storage Time |  | $t_s$ | — | 1.0 | $\mu\text{s}$ |
| Fall Time    |  | $t_f$ | — | 0.8 | $\mu\text{s}$ |

\* Indicates JEDEC Registered Data.

(1) Pulse Test: Pulse Width  $\leq 300\ \mu\text{s}$ , Duty Cycle  $\leq 2.0\%$

(2)  $f_T = |h_{fe}| \cdot f_{test}$ .

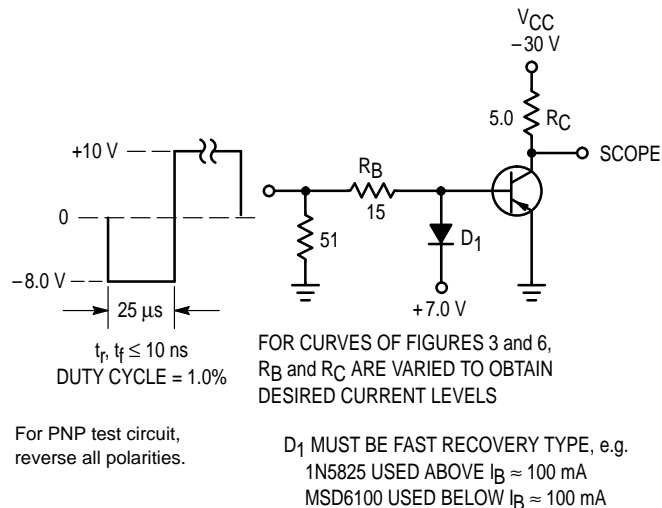

**Figure 2. Switching Times Test Circuit**

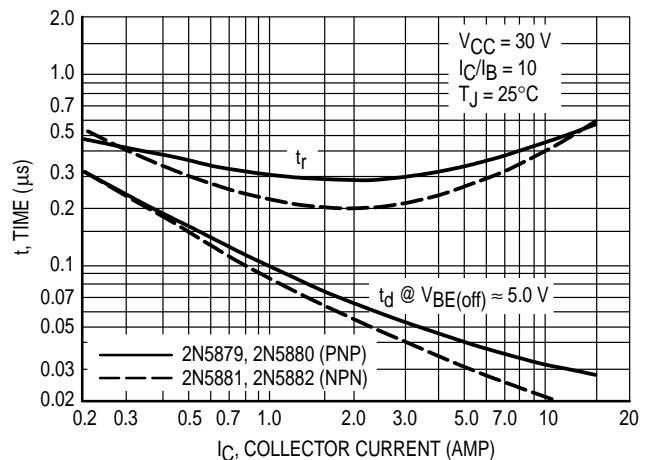

**Figure 3. Turn–On Time**

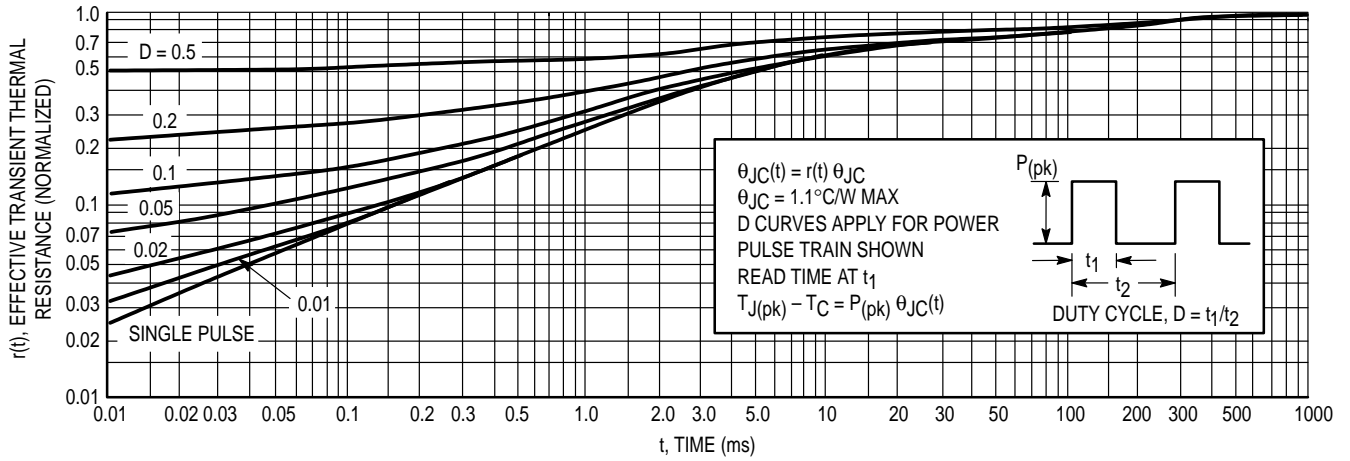

Figure 4. Thermal Response

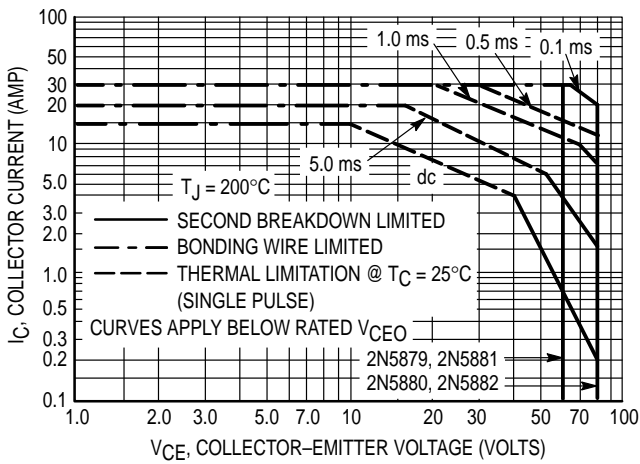

Figure 5. Active-Region Safe Operating Area

There are two limitations on the power handling ability of a transistor: average junction temperature and second breakdown. Safe operating area curves indicate  $I_C - V_{CE}$  limits of the transistor that must be observed for reliable operation, i.e., the transistor must not be subjected to greater dissipation than the curves indicate.

The data of Figure 5 is based on  $T_{J(pk)} = 200^{\circ}\text{C}$ ;  $T_C$  is variable depending on conditions. Second breakdown pulse limits are valid for duty cycles to 10% provided  $T_{J(pk)} < 200^{\circ}\text{C}$ .  $T_{J(pk)}$  may be calculated from the data in Figure 4. At high case temperatures, thermal limitations will reduce the power that can be handled to values less than the limitations imposed by second breakdown.

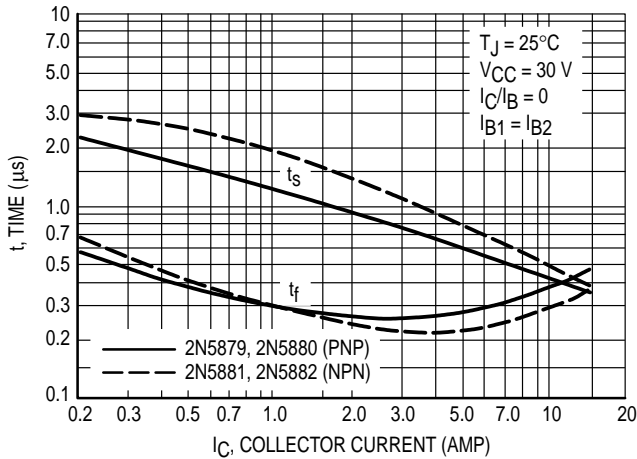

Figure 6. Turn-Off Time

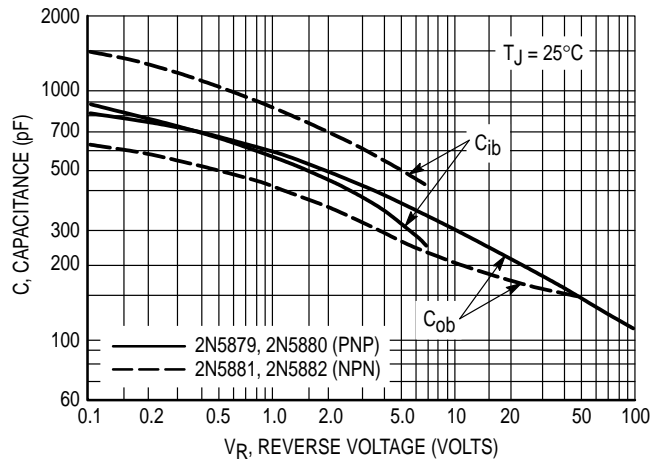

Figure 7. Capacitance

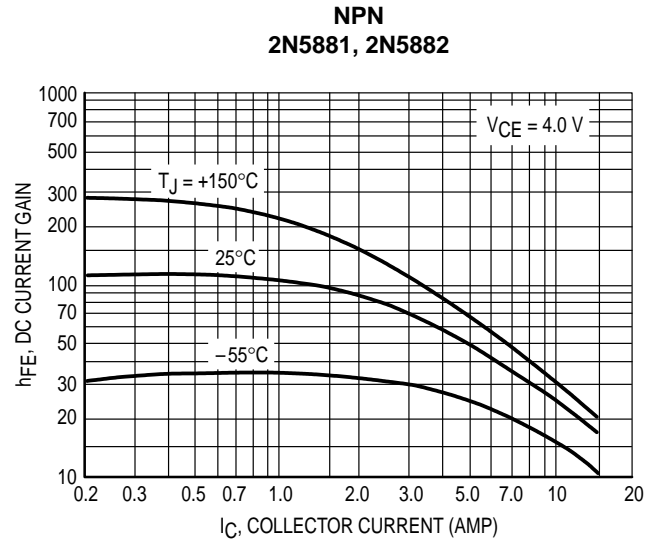
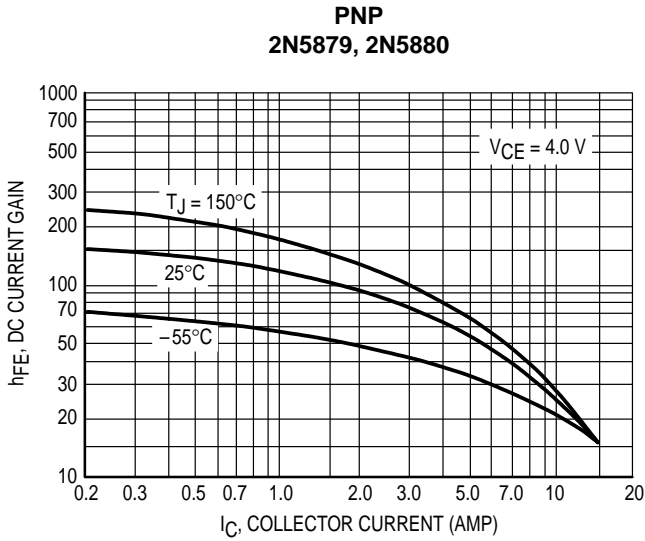

Figure 8. DC Current Gain

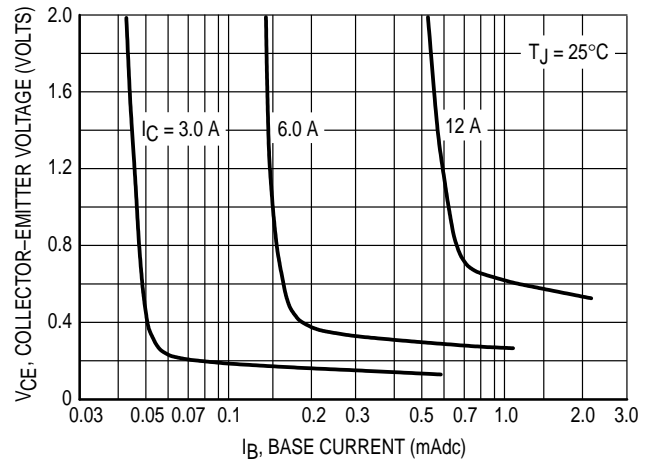
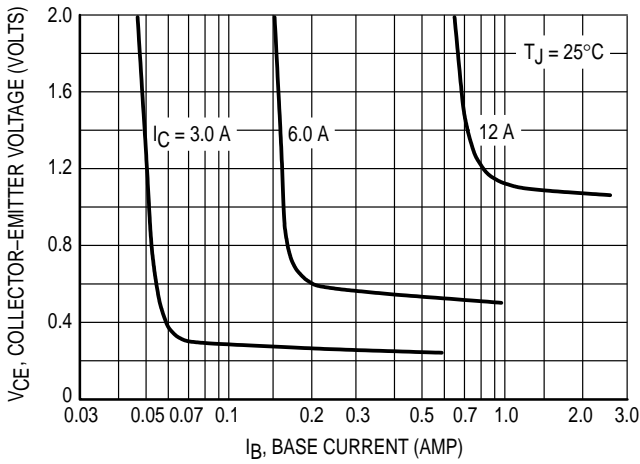

Figure 9. Collector Saturation Region

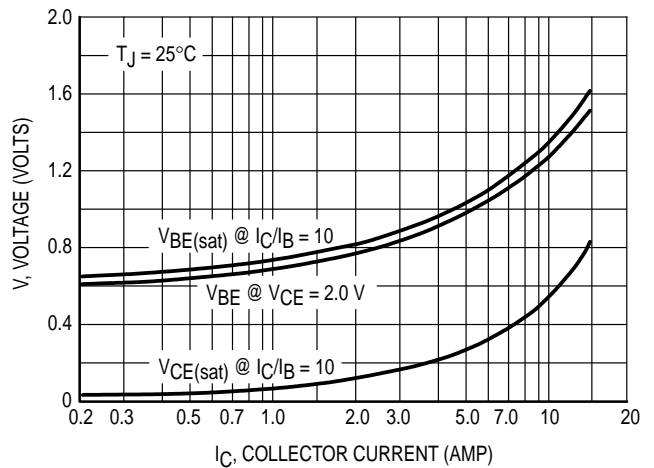
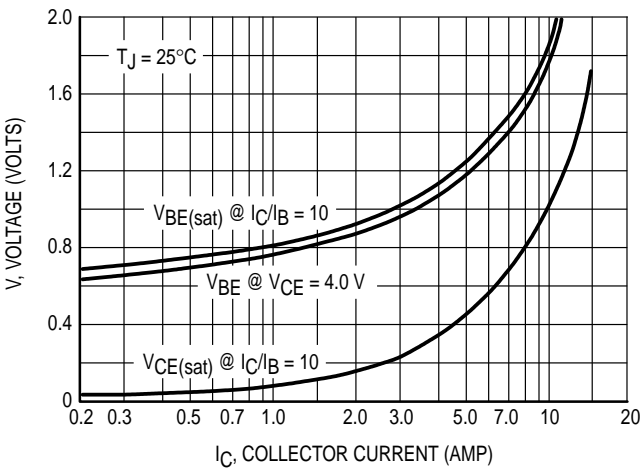
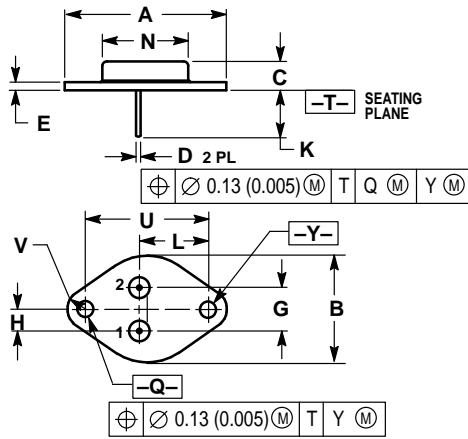

Figure 10. "On" Voltages

PACKAGE DIMENSIONS



- NOTES:  
 1. DIMENSIONING AND TOLERANCING PER ANSI Y14.5M, 1982.  
 2. CONTROLLING DIMENSION: INCH.  
 3. ALL RULES AND NOTES ASSOCIATED WITH REFERENCED TO-204AA OUTLINE SHALL APPLY.

| DIM | INCHES    |       | MILLIMETERS |       |
|-----|-----------|-------|-------------|-------|
|     | MIN       | MAX   | MIN         | MAX   |
| A   | 1.550 REF |       | 39.37 REF   |       |
| B   | —         | 1.050 | —           | 26.67 |
| C   | 0.250     | 0.335 | 6.35        | 8.51  |
| D   | 0.038     | 0.043 | 0.97        | 1.09  |
| E   | 0.055     | 0.070 | 1.40        | 1.77  |
| G   | 0.430 BSC |       | 10.92 BSC   |       |
| H   | 0.215 BSC |       | 5.46 BSC    |       |
| K   | 0.440     | 0.480 | 11.18       | 12.19 |
| L   | 0.665 BSC |       | 16.89 BSC   |       |
| N   | —         | 0.830 | —           | 21.08 |
| Q   | 0.151     | 0.165 | 3.84        | 4.19  |
| U   | 1.187 BSC |       | 30.15 BSC   |       |
| V   | 0.131     | 0.188 | 3.33        | 4.77  |

STYLE 1:  
 PIN 1. BASE  
 2. EMITTER  
 CASE: COLLECTOR

CASE 1-07  
 TO-204AA (TO-3)  
 ISSUE Z

Motorola reserves the right to make changes without further notice to any products herein. Motorola makes no warranty, representation or guarantee regarding the suitability of its products for any particular purpose, nor does Motorola assume any liability arising out of the application or use of any product or circuit, and specifically disclaims any and all liability, including without limitation consequential or incidental damages. "Typical" parameters can and do vary in different applications. All operating parameters, including "Typicals" must be validated for each customer application by customer's technical experts. Motorola does not convey any license under its patent rights nor the rights of others. Motorola products are not designed, intended, or authorized for use as components in systems intended for surgical implant into the body, or other applications intended to support or sustain life, or for any other application in which the failure of the Motorola product could create a situation where personal injury or death may occur. Should Buyer purchase or use Motorola products for any such unintended or unauthorized application, Buyer shall indemnify and hold Motorola and its officers, employees, subsidiaries, affiliates, and distributors harmless against all claims, costs, damages, and expenses, and reasonable attorney fees arising out of, directly or indirectly, any claim of personal injury or death associated with such unintended or unauthorized use, even if such claim alleges that Motorola was negligent regarding the design or manufacture of the part. Motorola and  are registered trademarks of Motorola, Inc. Motorola, Inc. is an Equal Opportunity/Affirmative Action Employer.

**How to reach us:**

**USA / EUROPE:** Motorola Literature Distribution;  
P.O. Box 20912; Phoenix, Arizona 85036. 1-800-441-2447

**JAPAN:** Nippon Motorola Ltd.; Tatsumi-SPD-JLDC, Toshikatsu Otsuki,  
6F Seibu-Butsuryu-Center, 3-14-2 Tatsumi Koto-Ku, Tokyo 135, Japan. 03-3521-8315

**MFAX:** RMFAX0@email.sps.mot.com - TOUCHTONE (602) 244-6609  
**INTERNET:** <http://Design-NET.com>

**HONG KONG:** Motorola Semiconductors H.K. Ltd.; 8B Tai Ping Industrial Park,  
51 Ting Kok Road, Tai Po, N.T., Hong Kong. 852-26629298

