

DATA SHEET

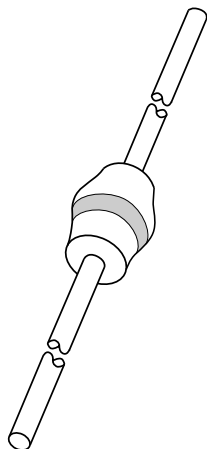

BZW03 series Voltage regulator diodes

Product specification
Supersedes data of April 1992
File under Discrete Semiconductors, SC01

1996 May 14

Voltage regulator diodes

BZW03 series

FEATURES

- Glass passivated
- High maximum operating temperature
- Low leakage current
- Excellent stability
- Zener working voltage range: 7.5 to 270 V for 38 types
- Transient suppressor stand-off voltage range: 6.2 to 430 V for 45 types
- Available in ammo-pack
- Also available with preformed leads for easy insertion.

DESCRIPTION

Rugged glass SOD64 package, using a high temperature alloyed

construction. This package is hermetically sealed and fatigue free as coefficients of expansion of all used parts are matched.

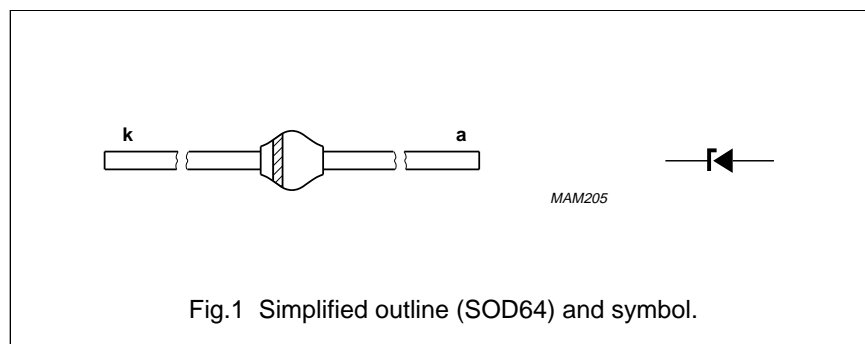

LIMITING VALUES

In accordance with the Absolute Maximum Rating System (IEC 134).

SYMBOL	PARAMETER	CONDITIONS	MIN.	MAX.	UNIT
P _{tot}	total power dissipation	T _{tp} = 25 °C; lead length 10 mm; see Fig.2	–	6.00	W
		T _{amb} = 45 °C; see Fig.2; PCB mounted (see Fig.6)	–	1.75	W
P _{ZRM}	repetitive peak reverse power dissipation		–	20	W
P _{ZSM}	non-repetitive peak reverse power dissipation	t _p = 100 μs; square pulse; T _j = 25 °C prior to surge; see Fig.3	–	1000	W
P _{RSM}	non-repetitive peak reverse power dissipation	10/1000 μs exponential pulse (see Fig.7); T _j = 25 °C prior to surge; see Fig.4	–	500	W
T _{stg}	storage temperature		–65	+175	°C
T _j	junction temperature		–65	+175	°C

Voltage regulator diodes

BZW03 series

ELECTRICAL CHARACTERISTICS

Total series

$T_j = 25\text{ }^\circ\text{C}$ unless otherwise specified.

SYMBOL	PARAMETER	CONDITIONS	MAX.	UNIT
V_F	forward voltage	$I_F = 1\text{ A}$; see Fig.5	1.2	V

Per type when used as voltage regulator diodes

$T_j = 25\text{ }^\circ\text{C}$ unless otherwise specified.

TYPE No. SUFFIX (1)	WORKING VOLTAGE			DIFFERENTIAL RESISTANCE		TEMPERATURE COEFFICIENT		TEST CURRENT I_Z (mA)	REVERSE CURRENT at REVERSE VOLTAGE	
	V_Z (V) at I_Z			r_{dif} (Ω) at I_Z		S_Z (%/K) at I_Z			I_R (μA) MAX.	at V_R (V)
	MIN.	NOM.	MAX.	TYP.	MAX.	MIN.	MAX.			
C7V5	7.0	7.5	7.9	0.7	1.5	0.00	0.07	175	1500	5.6
C8V2	7.7	8.2	8.7	0.8	1.5	0.03	0.08	150	1200	6.2
C9V1	8.5	9.1	9.6	0.9	2.0	0.03	0.08	150	40	6.8
C10	9.4	10	10.6	1.0	2.0	0.05	0.09	125	20	7.5
C11	10.4	11	11.6	1.1	2.5	0.05	0.10	125	15	8.2
C12	11.4	12	12.7	1.1	2.5	0.05	0.10	100	10	9.1
C13	12.4	13	14.1	1.2	2.5	0.05	0.10	100	4	10
C15	13.8	15	15.6	1.2	2.5	0.05	0.10	75	2	11
C16	15.3	16	17.1	1.3	2.5	0.06	0.11	75	2	12
C18	16.8	18	19.1	1.3	2.5	0.06	0.11	65	2	13
C20	18.8	20	21.2	1.5	3.0	0.06	0.11	65	2	15
C22	20.8	22	23.3	1.6	3.5	0.06	0.11	50	2	16
C24	22.8	24	25.6	1.8	3.5	0.06	0.11	50	2	18
C27	25.1	27	28.9	2.5	5	0.06	0.11	50	2	20
C30	28	30	32	4	8	0.06	0.11	40	2	22
C33	31	33	35	5	10	0.06	0.11	40	2	24
C36	34	36	38	6	11	0.06	0.11	30	2	27
C39	37	39	41	7	14	0.06	0.11	30	2	30
C43	40	43	46	10	20	0.07	0.12	30	2	33
C47	44	47	50	12	25	0.07	0.12	25	2	36
C51	48	51	54	14	27	0.07	0.12	25	2	39
C56	52	56	60	18	35	0.07	0.12	20	2	43
C62	58	62	66	20	42	0.08	0.13	20	2	47
C68	64	68	72	22	44	0.08	0.13	20	2	51
C75	70	75	79	25	45	0.08	0.13	20	2	56
C82	77	82	87	30	65	0.08	0.13	15	2	62
C91	85	91	96	40	75	0.09	0.13	15	2	68

Voltage regulator diodes

BZW03 series

TYPE No. SUFFIX (1)	WORKING VOLTAGE			DIFFERENTIAL RESISTANCE		TEMPERATURE COEFFICIENT		TEST CURRENT I_Z (mA)	REVERSE CURRENT at REVERSE VOLTAGE	
	V_Z (V) at I_Z			r_{dif} (Ω) at I_Z		S_Z (%/K) at I_Z			I_R (μ A) MAX.	at V_R (V)
	MIN.	NOM.	MAX.	TYP.	MAX.	MIN.	MAX.			
C100	94	100	106	45	90	0.09	0.13	12	2	75
C110	104	110	116	65	125	0.09	0.13	12	2	82
C120	114	120	127	90	170	0.09	0.13	10	2	91
C130	124	130	141	100	190	0.09	0.13	10	2	100
C150	138	150	156	150	330	0.09	0.13	8	2	110
C160	153	160	171	180	350	0.09	0.13	8	2	120
C180	168	180	191	210	430	0.09	0.13	5	2	130
C200	188	200	212	250	500	0.09	0.13	5	2	150
C220	208	220	233	350	700	0.09	0.13	5	2	160
C240	228	240	256	450	900	0.09	0.13	5	2	180
C270	251	270	289	600	1200	0.09	0.13	5	2	200

Note

1. To complete the type number the suffix is added to the basic type number, e.g. BZW03-C100.

Voltage regulator diodes

BZW03 series

Per type when used as transient suppressor diodes

 $T_j = 25\text{ }^\circ\text{C}$ unless otherwise specified.

TYPE NUMBER	REVERSE BREAKDOWN VOLTAGE	TEMPERATURE COEFFICIENT		TEST CURRENT	CLAMPING VOLTAGE		REVERSE CURRENT at STAND-OFF VOLTAGE	
	$V_{(BR)R}$ (V) at I_{test}	S_z (%/K) at I_{test}		I_{test} (mA)	$V_{(CL)R}$ (V)	at I_{RSM} (A) note 1	I_R (μ A)	at V_R (V)
	MIN.	MIN.	MAX.		MAX.		MAX.	
BZW03-C7V5	7.0	0.00	0.07	175	11.3	44.2	3000	6.2
BZW03-C8V2	7.7	0.03	0.08	150	12.3	40.6	2400	6.8
BZW03-C9V1	8.5	0.03	0.08	150	13.3	37.6	100	7.5
BZW03-C10	9.4	0.05	0.09	125	14.8	34.0	40	8.2
BZW03-C11	10.4	0.05	0.10	125	15.7	31.8	30	9.1
BZW03-C12	11.4	0.05	0.10	100	17.0	29.4	20	10
BZW03-C13	12.4	0.05	0.10	100	18.9	26.4	10	11
BZW03-C15	13.8	0.05	0.10	75	20.9	23.9	10	12
BZW03-C16	15.3	0.06	0.11	75	22.9	21.8	10	13
BZW03-C18	16.8	0.06	0.11	65	25.6	19.5	10	15
BZW03-C20	18.8	0.06	0.11	65	28.4	17.6	10	16
BZW03-C22	20.8	0.06	0.11	50	31.0	16.1	10	18
BZW03-C24	22.8	0.06	0.11	50	33.8	14.8	10	20
BZW03-C27	25.1	0.06	0.11	50	38.1	13.1	10	22
BZW03-C30	28	0.06	0.11	40	42.2	11.8	10	24
BZW03-C33	31	0.06	0.11	40	46.2	10.8	10	27
BZW03-C36	34	0.06	0.11	30	50.1	10.0	10	30
BZW03-C39	37	0.06	0.11	30	54.1	9.2	10	33
BZW03-C43	40	0.07	0.12	30	60.7	8.2	10	36
BZW03-C47	44	0.07	0.12	25	65.5	7.6	10	39
BZW03-C51	48	0.07	0.12	25	70.8	7.0	10	43
BZW03-C56	52	0.07	0.12	20	78.6	6.3	10	47
BZW03-C62	58	0.08	0.13	20	86.5	5.8	10	51
BZW03-C68	64	0.08	0.13	20	94.4	5.3	10	56
BZW03-C75	70	0.08	0.13	20	103.5	4.8	10	62
BZW03-C82	77	0.08	0.13	15	114.0	4.3	10	68
BZW03-C91	85	0.09	0.13	15	126	3.9	10	75
BZW03-C100	94	0.09	0.13	12	139	3.6	10	82
BZW03-C110	104	0.09	0.13	12	152	3.3	10	91
BZW03-C120	114	0.09	0.13	10	167	3.0	10	100
BZW03-C130	124	0.09	0.13	10	185	2.7	10	110
BZW03-C150	138	0.09	0.13	8	204	2.4	10	120
BZW03-C160	153	0.09	0.13	8	224	2.2	10	130

Voltage regulator diodes

BZW03 series

TYPE NUMBER	REVERSE BREAKDOWN VOLTAGE	TEMPERATURE COEFFICIENT		TEST CURRENT	CLAMPING VOLTAGE		REVERSE CURRENT at STAND-OFF VOLTAGE	
	$V_{(BR)R}$ (V) at I_{test}	S_Z (%/K) at I_{test}		I_{test} (mA)	$V_{(CL)R}$ (V)	at I_{RSM} (A) note 1	I_R (μ A)	at V_R (V)
	MIN.	MIN.	MAX.		MAX.		MAX.	
BZW03-C180	168	0.09	0.13	5	249	2.0	10	150
BZW03-C200	188	0.09	0.13	5	276	1.8	10	160
BZW03-C220	208	0.09	0.13	5	305	1.6	10	180
BZW03-C240	228	0.09	0.13	5	336	1.5	10	200
BZW03-C270	251	0.09	0.13	5	380	1.3	10	220
BZW03-C300	280	0.09	0.13	5	419	1.2	10	240
BZW03-C330	310	0.09	0.13	5	459	1.1	10	270
BZW03-C360	340	0.09	0.13	5	498	1.0	10	300
BZW03-C390	370	0.09	0.13	5	537	0.93	10	330
BZW03-C430	400	0.09	0.13	5	603	0.83	10	360
BZW03-C470	440	0.09	0.13	5	655	0.76	10	390
BZW03-C510	480	0.09	0.13	5	707	0.71	10	430

Note

1. Non-repetitive peak reverse current in accordance with "IEC 60-1, Section 8" (10/1000 μ s pulse); see Fig.7.

THERMAL CHARACTERISTICS

SYMBOL	PARAMETER	CONDITIONS	VALUE	UNIT
$R_{th\ j-tp}$	thermal resistance from junction to tie-point	lead length = 10 mm	25	K/W
$R_{th\ j-a}$	thermal resistance from junction to ambient	note 1	75	K/W

Note

1. Device mounted on an epoxy-glass printed-circuit board, 1.5 mm thick; thickness of Cu-layer $\geq 40\ \mu$ m, see Fig.6. For more information please refer to the 'General Part of Handbook SC01'.

Voltage regulator diodes

BZW03 series

GRAPHICAL DATA

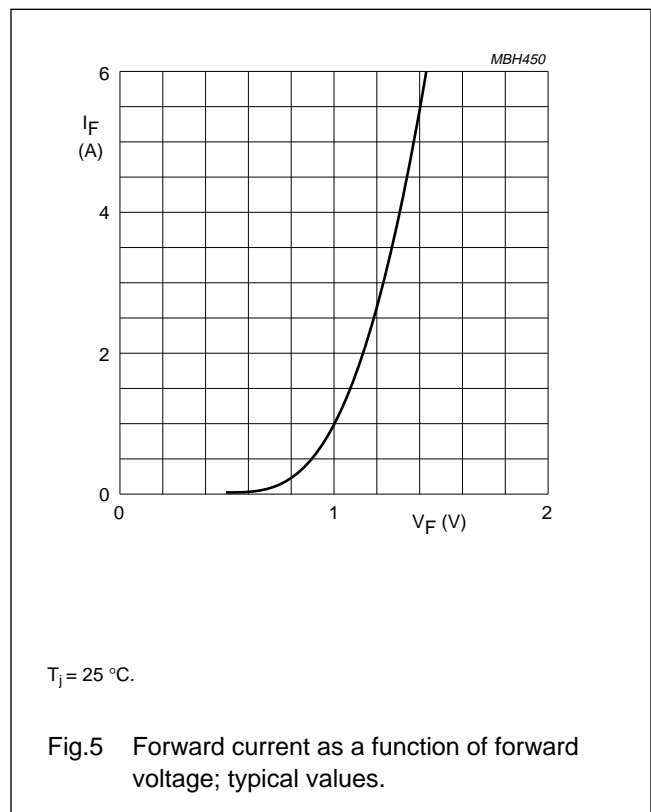
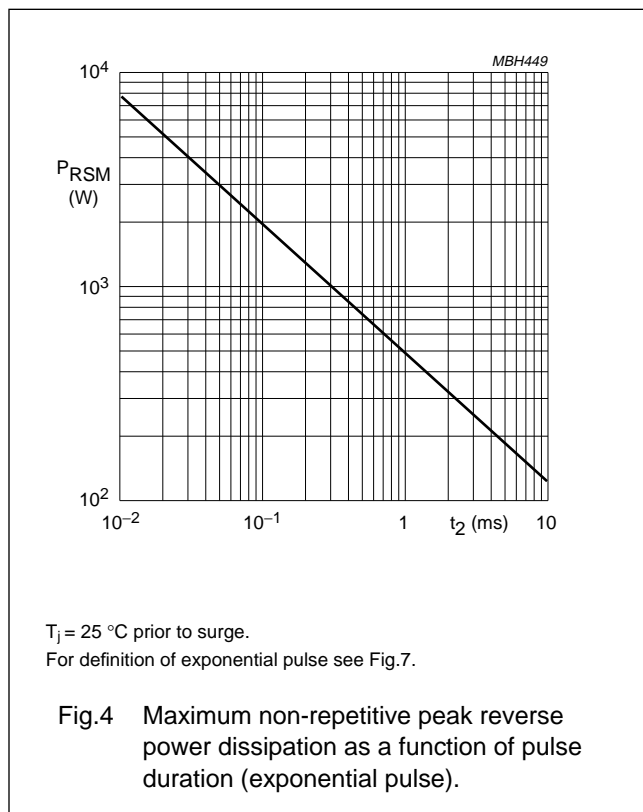
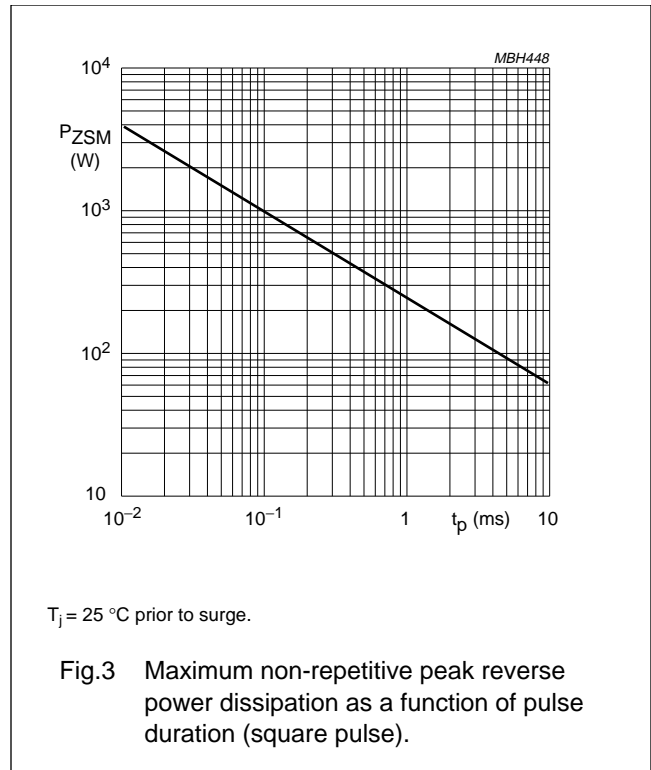
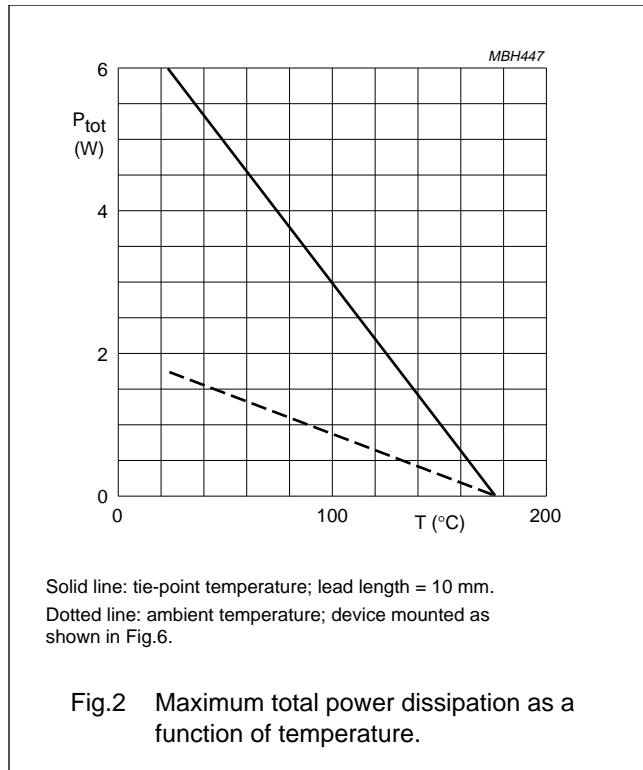

Voltage regulator diodes

BZW03 series

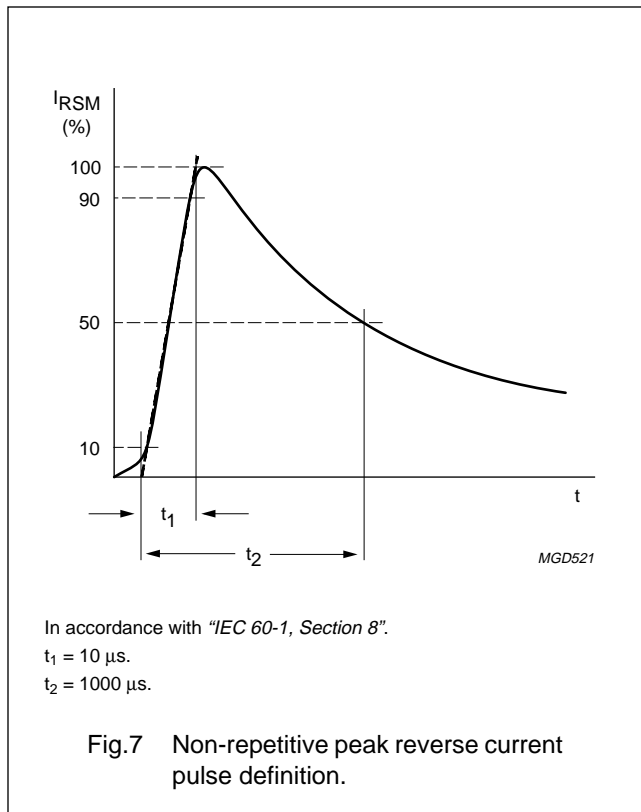
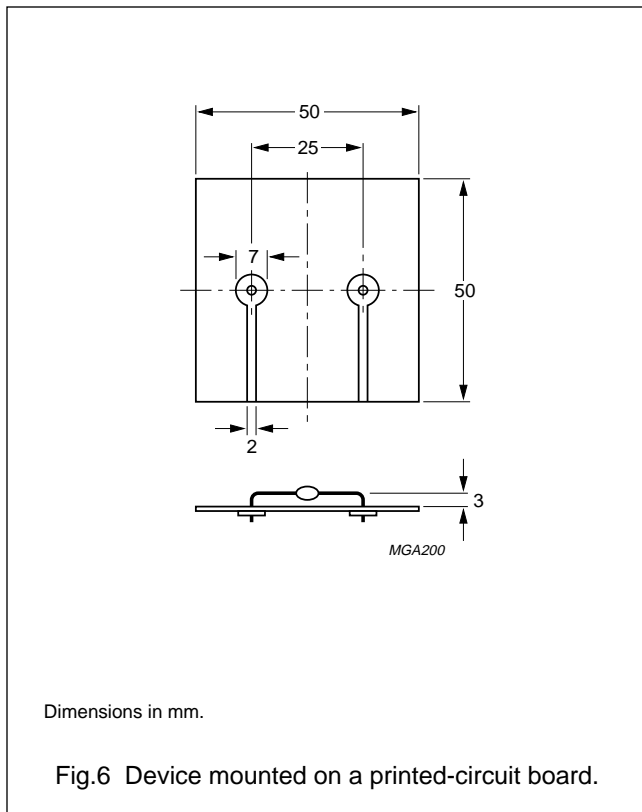

Voltage regulator diodes

BZW03 series

PACKAGE OUTLINE

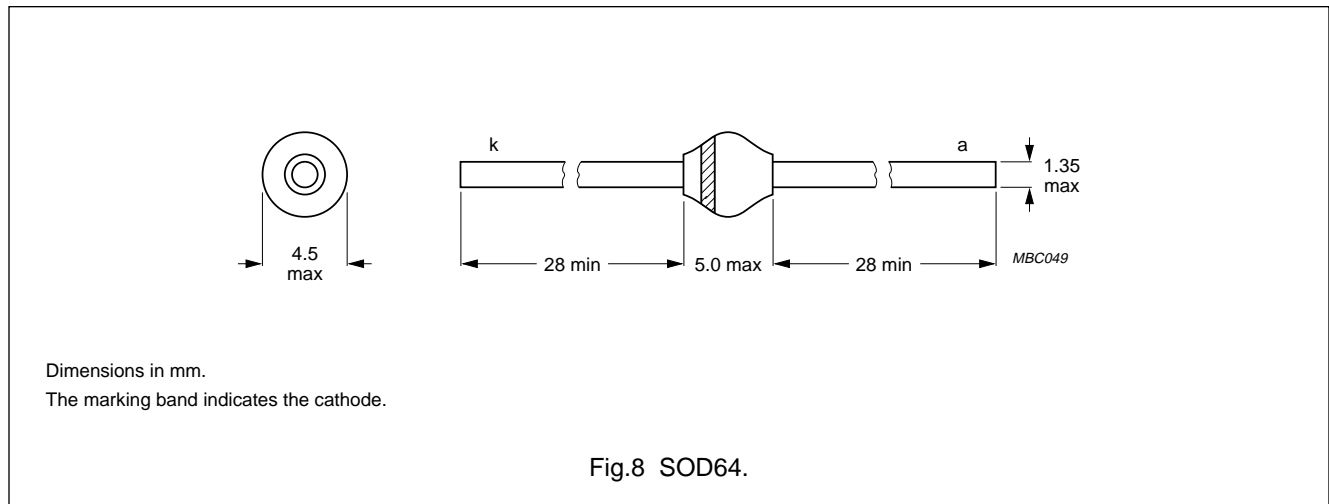

DEFINITIONS

Data sheet status	
Objective specification	This data sheet contains target or goal specifications for product development.
Preliminary specification	This data sheet contains preliminary data; supplementary data may be published later.
Product specification	This data sheet contains final product specifications.
Limiting values	
Limiting values given are in accordance with the Absolute Maximum Rating System (IEC 134). Stress above one or more of the limiting values may cause permanent damage to the device. These are stress ratings only and operation of the device at these or at any other conditions above those given in the Characteristics sections of the specification is not implied. Exposure to limiting values for extended periods may affect device reliability.	
Application information	
Where application information is given, it is advisory and does not form part of the specification.	

LIFE SUPPORT APPLICATIONS

These products are not designed for use in life support appliances, devices, or systems where malfunction of these products can reasonably be expected to result in personal injury. Philips customers using or selling these products for use in such applications do so at their own risk and agree to fully indemnify Philips for any damages resulting from such improper use or sale.