

# Triacs high commutation

## BTA208 series B

### GENERAL DESCRIPTION

Glass passivated high commutation triacs in a plastic envelope intended for use in motor control circuits or with other highly inductive loads. These devices will commute the full rated rms current at the maximum rated junction temperature, without the aid of a snubber.

### QUICK REFERENCE DATA

SYMBOL	PARAMETER	MAX.	MAX.	UNIT
		<b>600B</b>	<b>800B</b>	
$V_{DRM}$	Repetitive peak off-state voltages	600	800	V
$I_{T(RMS)}$	RMS on-state current	8	8	A
$I_{TSM}$	Non-repetitive peak on-state current	55	55	A

### PINNING - TO220AB

PIN	DESCRIPTION
1	main terminal 1
2	main terminal 2
3	gate
tab	main terminal 2

### PIN CONFIGURATION

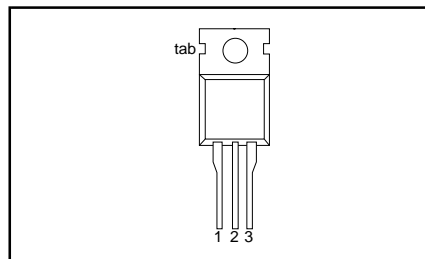

### SYMBOL

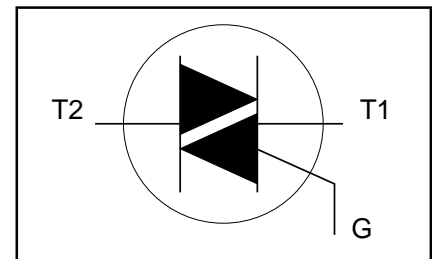

### LIMITING VALUES

Limiting values in accordance with the Absolute Maximum System (IEC 134).

SYMBOL	PARAMETER	CONDITIONS	MIN.	MAX.		UNIT
				-600 600 <sup>1</sup>	-800 800	
$V_{DRM}$	Repetitive peak off-state voltages		-			V
$I_{T(RMS)}$	RMS on-state current	full sine wave; $T_{mb} \leq 102^\circ\text{C}$	-	8		A
$I_{TSM}$	Non-repetitive peak on-state current	full sine wave; $T_j = 125^\circ\text{C}$ prior to surge; with reapplied $V_{DRM(max)}$ $t = 20\text{ ms}$	-	55		A
		$t = 16.7\text{ ms}$	-	60		A
$I^2t$	$I^2t$ for fusing	$t = 10\text{ ms}$	-	15		A <sup>2</sup> s
$di_T/dt$	Repetitive rate of rise of on-state current after triggering	$I_{TM} = 12\text{ A}$ ; $I_G = 0.2\text{ A}$ ; $di_G/dt = 0.2\text{ A}/\mu\text{s}$	-	100		A/ $\mu\text{s}$
$I_{GM}$	Peak gate current		-	2		A
$V_{GM}$	Peak gate voltage		-	5		V
$P_{GM}$	Peak gate power		-	5		W
$P_{G(AV)}$	Average gate power	over any 20 ms period	-	0.5		W
$T_{stg}$	Storage temperature		-40	150		$^\circ\text{C}$
$T_j$	Operating junction temperature		-	125		$^\circ\text{C}$

<sup>1</sup> Although not recommended, off-state voltages up to 800V may be applied without damage, but the triac may switch to the on-state. The rate of rise of current should not exceed 6 A/ $\mu\text{s}$ .

# Triacs

## high commutation

BTA208 series B

### THERMAL RESISTANCES

SYMBOL	PARAMETER	CONDITIONS	MIN.	TYP.	MAX.	UNIT
$R_{th\ j-mb}$	Thermal resistance junction to mounting base	full cycle	-	-	2.0	K/W
		half cycle	-	-	2.4	K/W
$R_{th\ j-a}$	Thermal resistance junction to ambient	in free air	-	60	-	K/W

### STATIC CHARACTERISTICS

 $T_j = 25\text{ }^\circ\text{C}$  unless otherwise stated

SYMBOL	PARAMETER	CONDITIONS	MIN.	TYP.	MAX.	UNIT
$I_{GT}$	Gate trigger current <sup>2</sup>	$V_D = 12\text{ V}$ ; $I_T = 0.1\text{ A}$				
		T2+ G+	2	18	50	mA
		T2+ G-	2	21	50	mA
		T2- G-	2	34	50	mA
$I_L$	Latching current	$V_D = 12\text{ V}$ ; $I_{GT} = 0.1\text{ A}$				
		T2+ G+	-	31	60	mA
		T2+ G-	-	34	90	mA
		T2- G-	-	30	60	mA
$I_H$	Holding current	$V_D = 12\text{ V}$ ; $I_{GT} = 0.1\text{ A}$	-	31	60	mA
$V_T$	On-state voltage	$I_T = 10\text{ A}$	-	1.3	1.65	V
$V_{GT}$	Gate trigger voltage	$V_D = 12\text{ V}$ ; $I_T = 0.1\text{ A}$	-	0.7	1.5	V
		$V_D = 400\text{ V}$ ; $I_T = 0.1\text{ A}$ ; $T_j = 125\text{ }^\circ\text{C}$	0.25	0.4	-	V
$I_D$	Off-state leakage current	$V_D = V_{DRM(max)}$ ; $T_j = 125\text{ }^\circ\text{C}$	-	0.1	0.5	mA

### DYNAMIC CHARACTERISTICS

 $T_j = 25\text{ }^\circ\text{C}$  unless otherwise stated

SYMBOL	PARAMETER	CONDITIONS	MIN.	TYP.	MAX.	UNIT
$dV_D/dt$	Critical rate of rise of off-state voltage	$V_{DM} = 67\% V_{DRM(max)}$ ; $T_j = 125\text{ }^\circ\text{C}$ ; exponential waveform; gate open circuit	1000	4000	-	V/ $\mu\text{s}$
$dI_{com}/dt$	Critical rate of change of commutating current	$V_{DM} = 400\text{ V}$ ; $T_j = 125\text{ }^\circ\text{C}$ ; $I_{T(RMS)} = 8\text{ A}$ ; without snubber; gate open circuit	-	14	-	A/ms
$t_{gt}$	Gate controlled turn-on time	$I_{TM} = 12\text{ A}$ ; $V_D = V_{DRM(max)}$ ; $I_G = 0.1\text{ A}$ ; $dI_G/dt = 5\text{ A}/\mu\text{s}$	-	2	-	$\mu\text{s}$

<sup>2</sup> Device does not trigger in the T2-, G+ quadrant.

Triacs  
high commutation

BTA208 series B

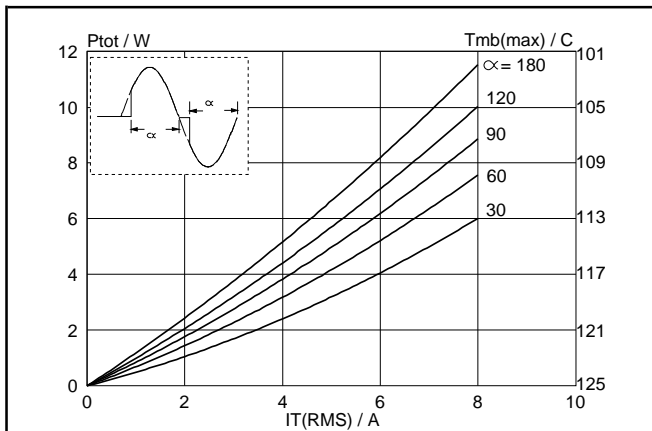

Fig.1. Maximum on-state dissipation,  $P_{tot}$ , versus rms on-state current,  $I_{T(RMS)}$ , where  $\alpha =$  conduction angle.

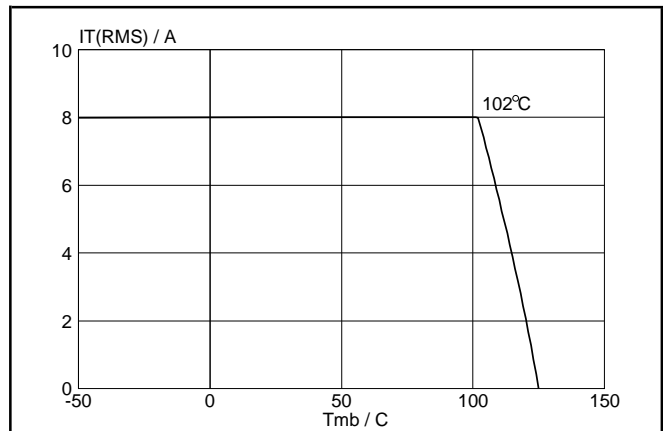

Fig.4. Maximum permissible rms current  $I_{T(RMS)}$ , versus mounting base temperature  $T_{mb}$ .

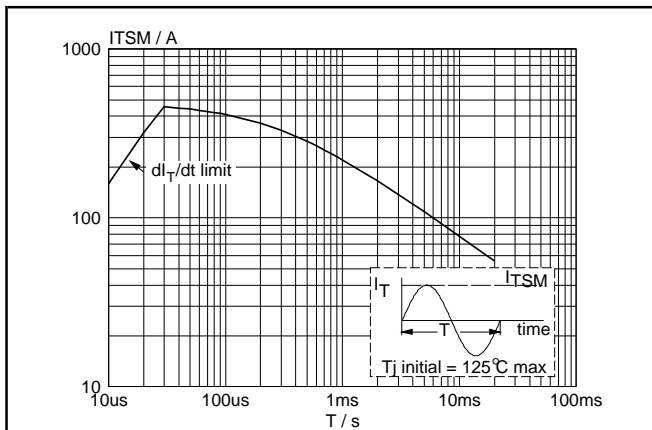

Fig.2. Maximum permissible non-repetitive peak on-state current  $I_{TSM}$ , versus pulse width  $t_p$ , for sinusoidal currents,  $t_p \leq 20$ ms.

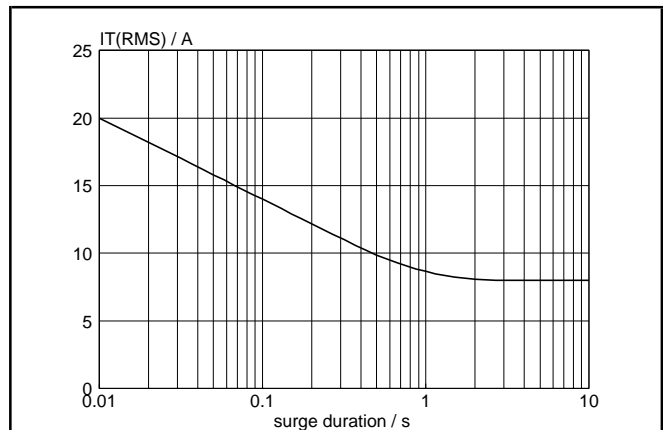

Fig.5. Maximum permissible repetitive rms on-state current  $I_{T(RMS)}$ , versus surge duration, for sinusoidal currents,  $f = 50$  Hz;  $T_{mb} \leq 102^\circ\text{C}$ .

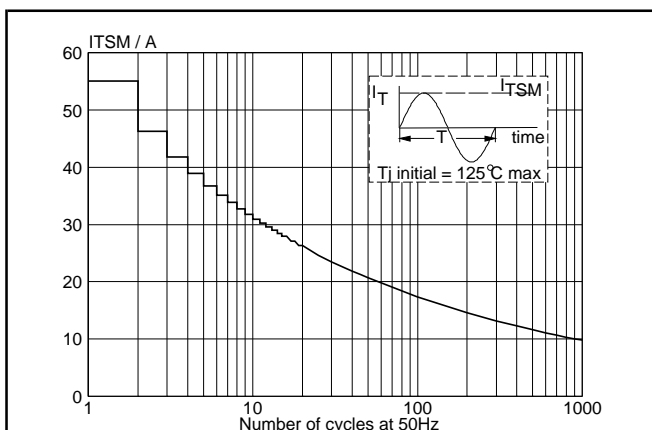

Fig.3. Maximum permissible non-repetitive peak on-state current  $I_{TSM}$ , versus number of cycles, for sinusoidal currents,  $f = 50$  Hz.

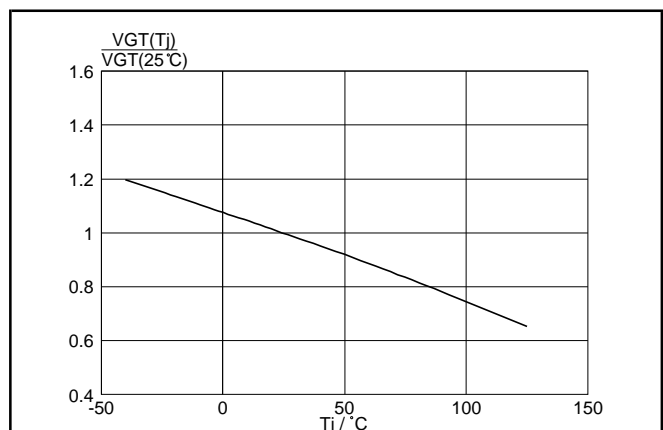
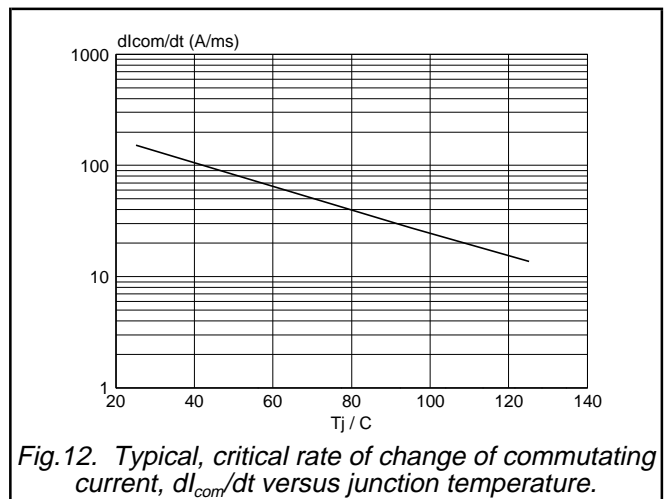
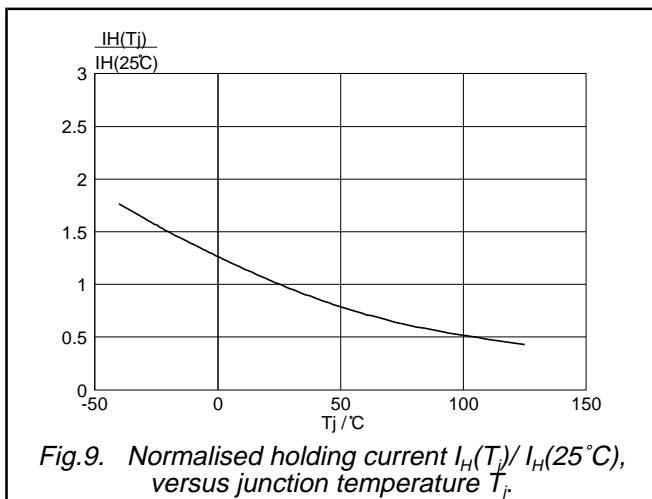
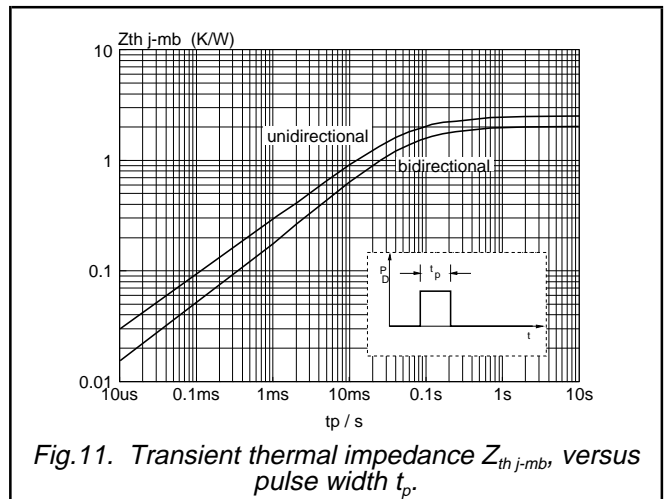
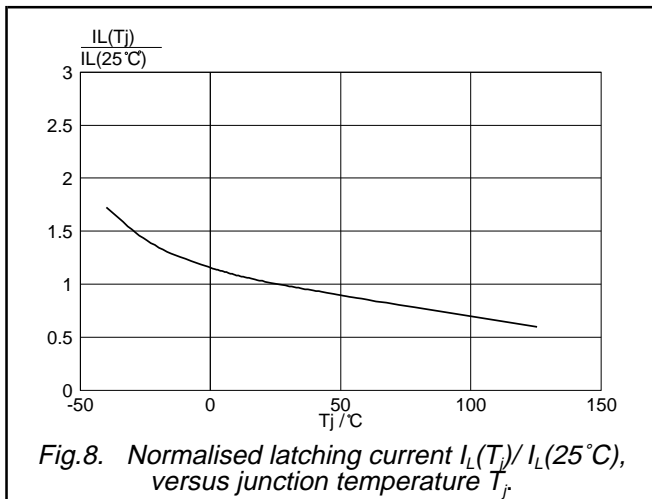
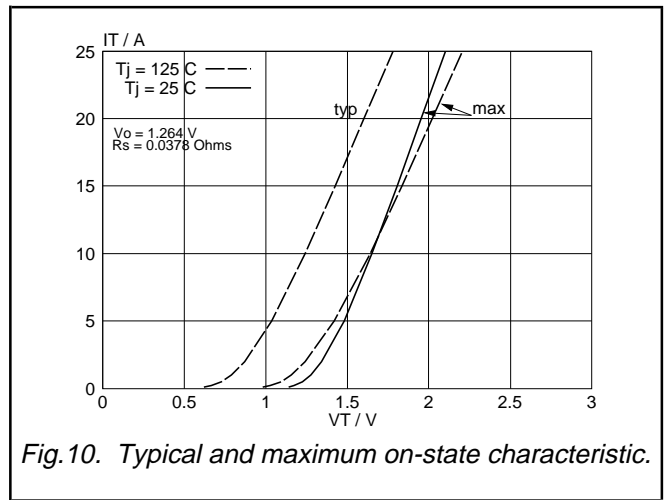
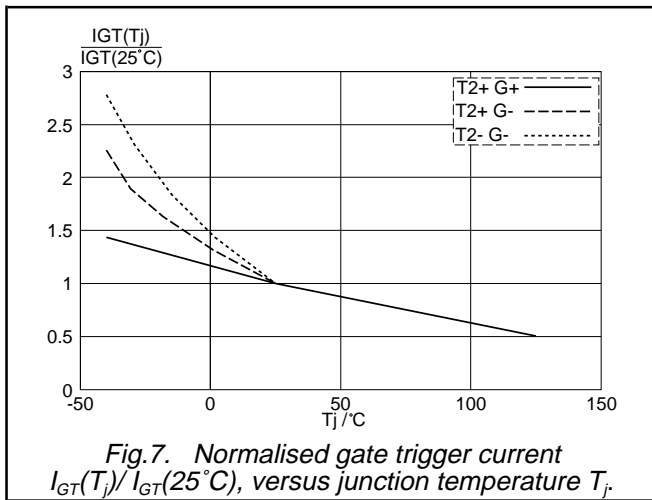

Fig.6. Normalised gate trigger voltage  $V_{GT}(T_j) / V_{GT}(25^\circ\text{C})$ , versus junction temperature  $T_j$ .

Triacs  
high commutation

BTA208 series B



Triacs  
high commutation

BTA208 series B

**MECHANICAL DATA**

*Dimensions in mm*

*Net Mass: 2 g*

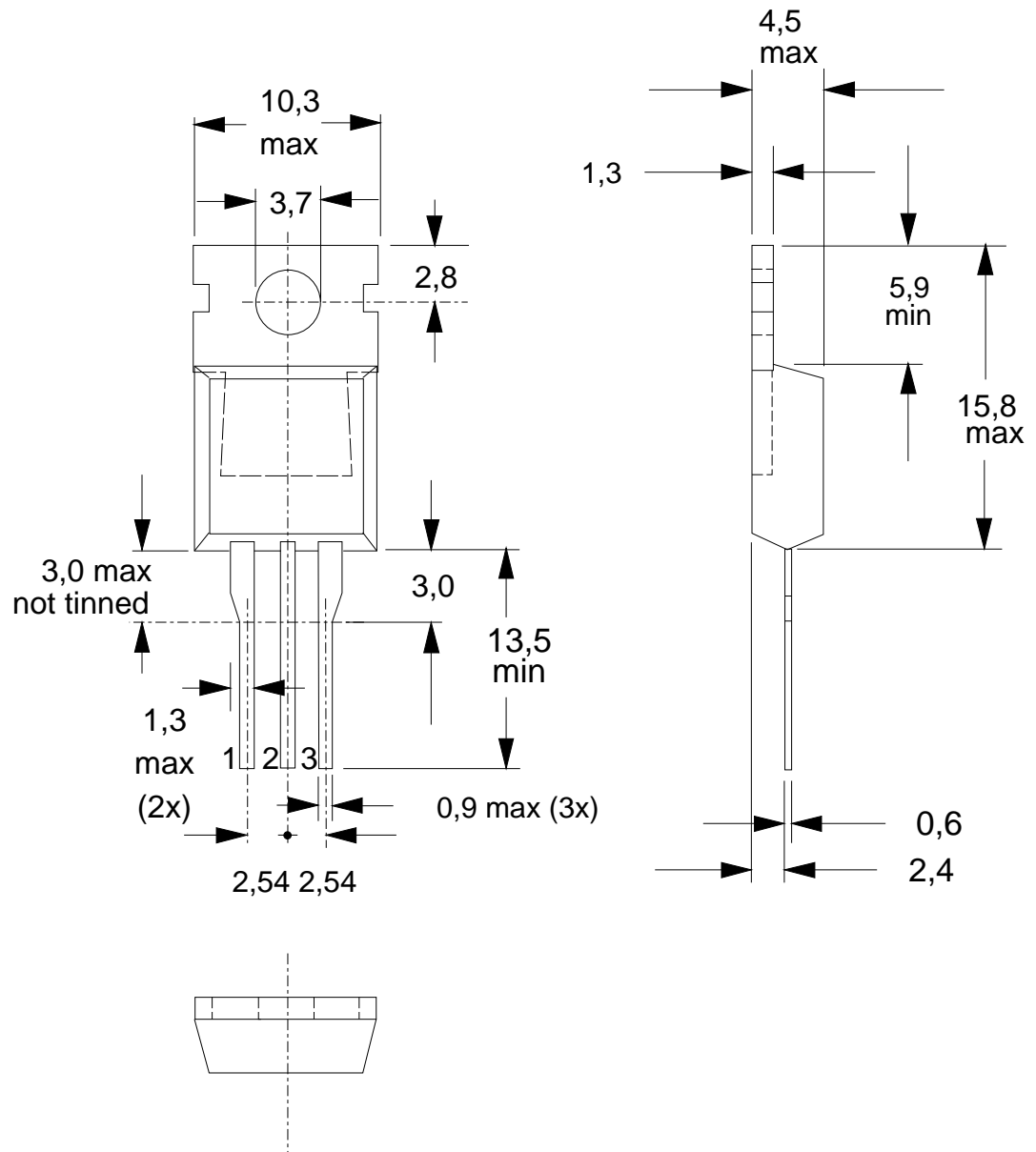

Fig.13. TO220AB; pin 2 connected to mounting base.

**Notes**

1. Accessories supplied on request: refer to mounting instructions for TO220 envelopes.
2. Epoxy meets UL94 V0 at 1/8".

# Triacs high commutation

BTA208 series B

## DEFINITIONS

<b>Data sheet status</b>	
Objective specification	This data sheet contains target or goal specifications for product development.
Preliminary specification	This data sheet contains preliminary data; supplementary data may be published later.
Product specification	This data sheet contains final product specifications.
<b>Limiting values</b>	
Limiting values are given in accordance with the Absolute Maximum Rating System (IEC 134). Stress above one or more of the limiting values may cause permanent damage to the device. These are stress ratings only and operation of the device at these or at any other conditions above those given in the Characteristics sections of this specification is not implied. Exposure to limiting values for extended periods may affect device reliability.	
<b>Application information</b>	
Where application information is given, it is advisory and does not form part of the specification.	
© Philips Electronics N.V. 1996	
All rights are reserved. Reproduction in whole or in part is prohibited without the prior written consent of the copyright owner.	
The information presented in this document does not form part of any quotation or contract, it is believed to be accurate and reliable and may be changed without notice. No liability will be accepted by the publisher for any consequence of its use. Publication thereof does not convey nor imply any license under patent or other industrial or intellectual property rights.	

## LIFE SUPPORT APPLICATIONS

These products are not designed for use in life support appliances, devices or systems where malfunction of these products can be reasonably expected to result in personal injury. Philips customers using or selling these products for use in such applications do so at their own risk and agree to fully indemnify Philips for any damages resulting from such improper use or sale.