

# DATA SHEET

## **BGY116D; BGY116E** UHF amplifier modules

Product specification  
Supersedes data of April 1994  
File under Discrete Semiconductors, SC09

1996 May 08

## UHF amplifier modules

## BGY116D; BGY116E

### FEATURES

- 12.5 V nominal supply voltage
- 6 W output power
- Easy control of output power by DC voltage.

### APPLICATIONS

- Mobile Radio equipment operating in the 800 to 870 and 890 to 950 MHz frequency ranges.

### DESCRIPTION

The BGY116D and BGY116E are five-stage UHF amplifier modules in a SOT278B package. Each module consists of 5 NPN silicon planar transistor dies mounted together with matching and bias circuit components on a metallized ceramic substrate.

### PINNING - SOT278B

PIN	DESCRIPTION
1	RF input
2	V <sub>C</sub>
3	V <sub>S</sub>
4	RF output
Flange	ground

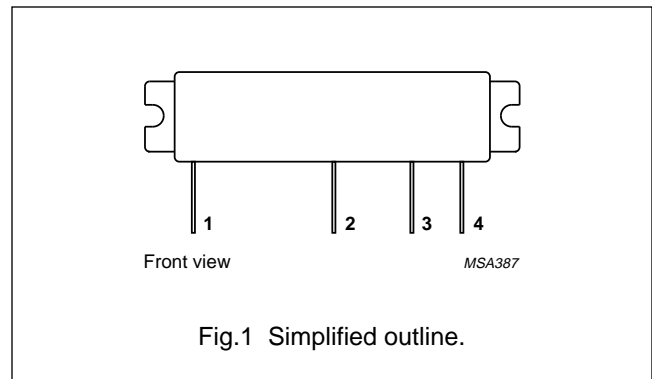

### QUICK REFERENCE DATA

RF performance at T<sub>mb</sub> = 25 °C.

TYPE NUMBER	MODE OF OPERATION	f (MHz)	V <sub>S</sub> (V)	P <sub>L</sub> (W)	G <sub>p</sub> (dB)	η (%)	Z <sub>S</sub> ; Z <sub>L</sub> (Ω)
BGY116D	CW	800 to 870	12.5	6	≥37.8	typ. 40	50
BGY116E	CW	890 to 950	12.5	6	≥37.8	typ. 40	50

### WARNING

#### Product and environmental safety - toxic materials

This product contains beryllium oxide. The product is entirely safe provided that the BeO slab is not damaged. All persons who handle, use or dispose of this product should be aware of its nature and of the necessary safety precautions. After use, dispose of as chemical or special waste according to the regulations applying at the location of the user. It must never be thrown out with the general or domestic waste.

UHF amplifier modules

BGY116D; BGY116E

**LIMITING VALUES**

In accordance with the Absolute Maximum Rating System (IEC 134).

SYMBOL	PARAMETER	MIN.	MAX.	UNIT
$V_S$	DC supply voltage	–	16	V
$V_C$	DC control voltage	–	8	V
$P_D$	input drive power	–	10	mW
$P_L$	load power	–	10	W
$T_{stg}$	storage temperature	–40	+100	°C
$T_{mb}$	operating mounting base temperature	–30	+100	°C

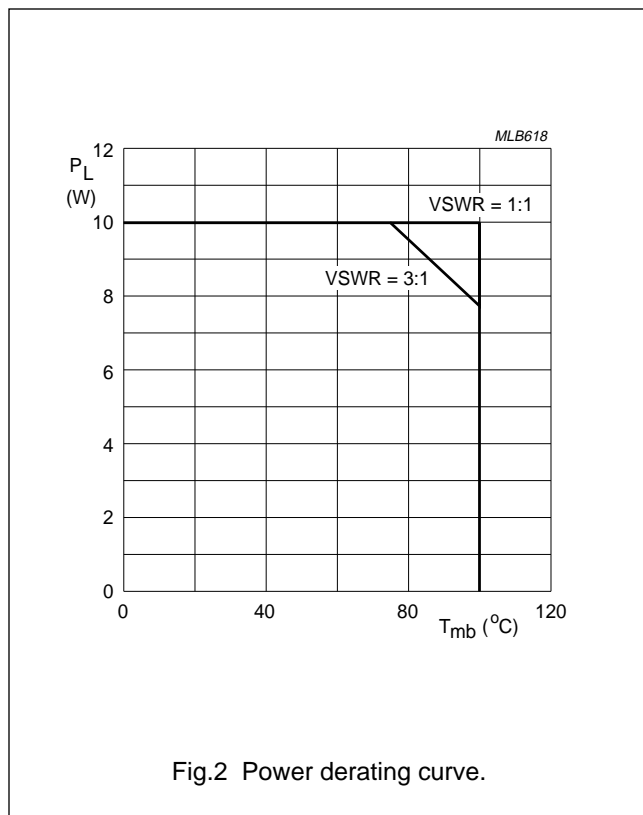

## UHF amplifier modules

## BGY116D; BGY116E

**CHARACTERISTICS**

$Z_S = Z_L = 50 \Omega$ ;  $P_D = 0$  dBm;  $V_S = 12.5$  V;  $V_C \leq 6$  V;  $T_{mb} = 25$  °C; unless otherwise specified.

SYMBOL	PARAMETER	CONDITIONS	MIN.	TYP.	MAX.	UNIT
f	frequency					
	BGY116D		800	–	870	MHz
	BGY116E		890	–	950	MHz
$I_Q$	quiescent current	$V_C = 0$ ; $P_D = 0$	–	–	1	mA
$I_C$	control current		–	–	0.5	mA
$P_L$	load power		6	–	–	W
$G_p$	power gain	adjust $V_C$ for $P_L = 6$ W	37.8	–	–	dB
$\eta$	efficiency	adjust $V_C$ for $P_L = 6$ W	33	40	–	%
$H_2$	second harmonic	adjust $V_C$ for $P_L = 6$ W	–	–	–35	dBc
$H_3$	third harmonic	adjust $V_C$ for $P_L = 6$ W	–	–	–35	dBc
$V_{SWR_{in}}$	input VSWR	adjust $V_C$ for $P_L = 6$ W	–	–	3 : 1	
	isolation	$V_C = 0$	–	–50	–40	dBm
	stability	$P_D = -3$ to $+3$ dBm; $V_S = 10$ to $16$ V; $V_C = 0$ to $6$ V; adjust $V_C$ for $P_L \leq 7$ W; $V_{SWR} \leq 6 : 1$	–	–	–60	dBc
	ruggedness	$V_S = 16$ V; adjust $V_C$ for $P_L = 7$ W; $V_{SWR} \leq 20 : 1$	no degradation			

UHF amplifier modules

BGY116D; BGY116E

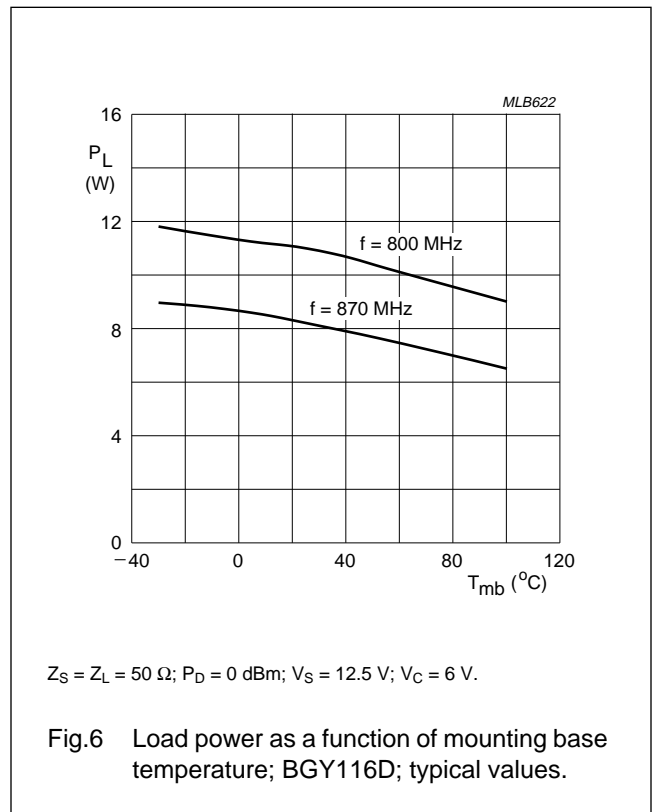
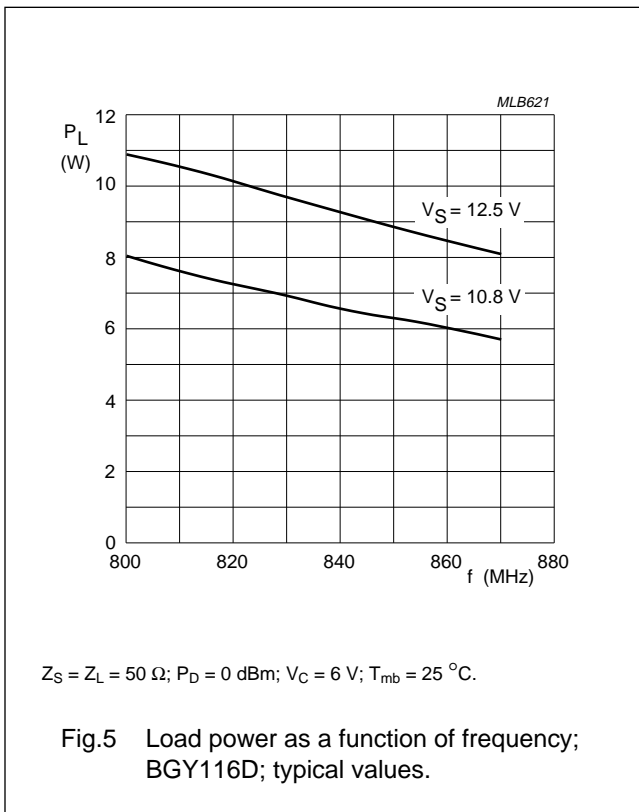
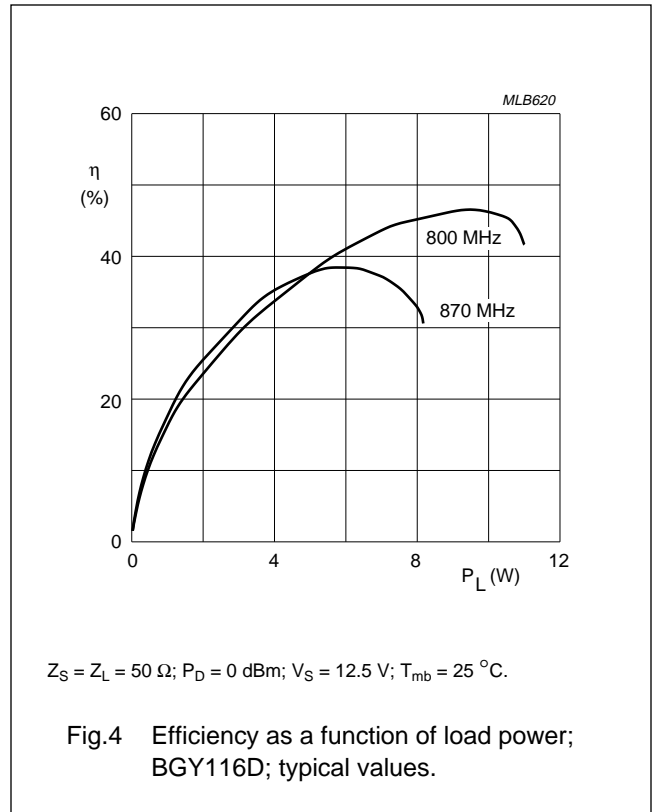
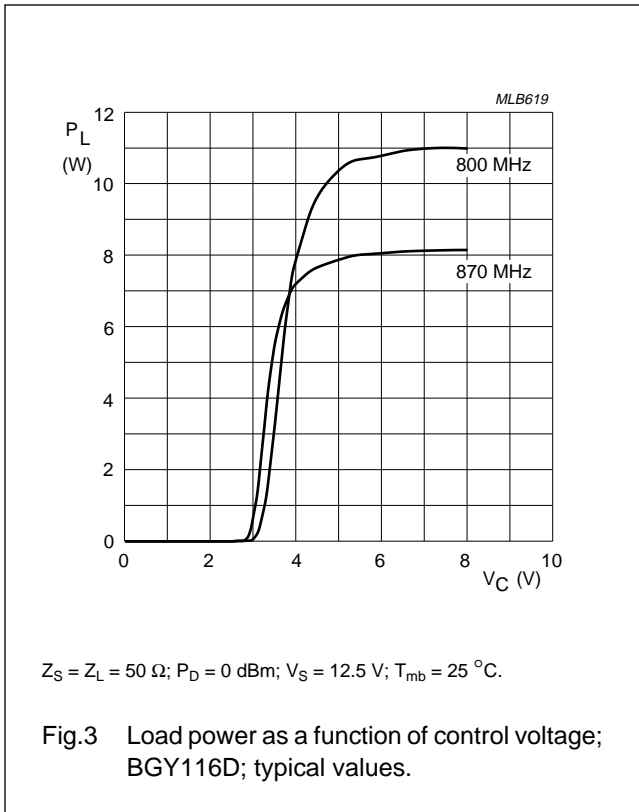

UHF amplifier modules

BGY116D; BGY116E

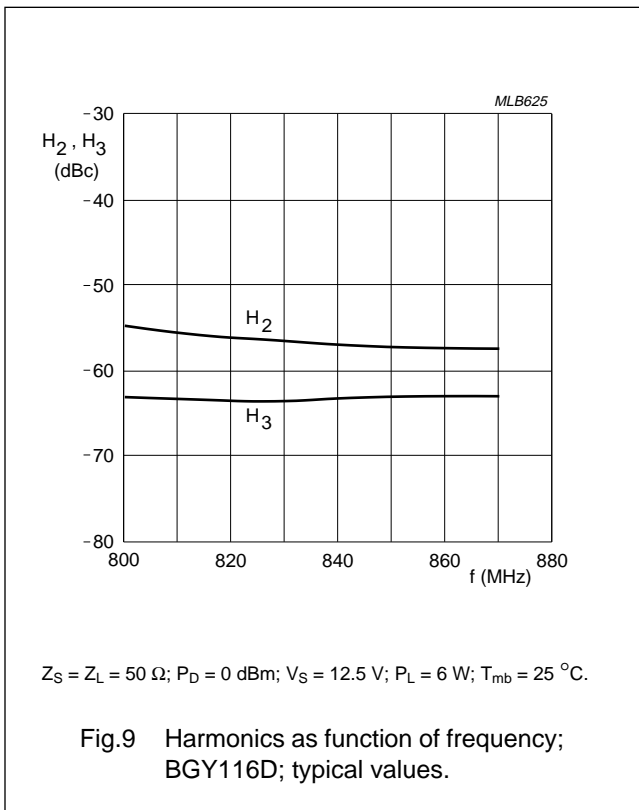
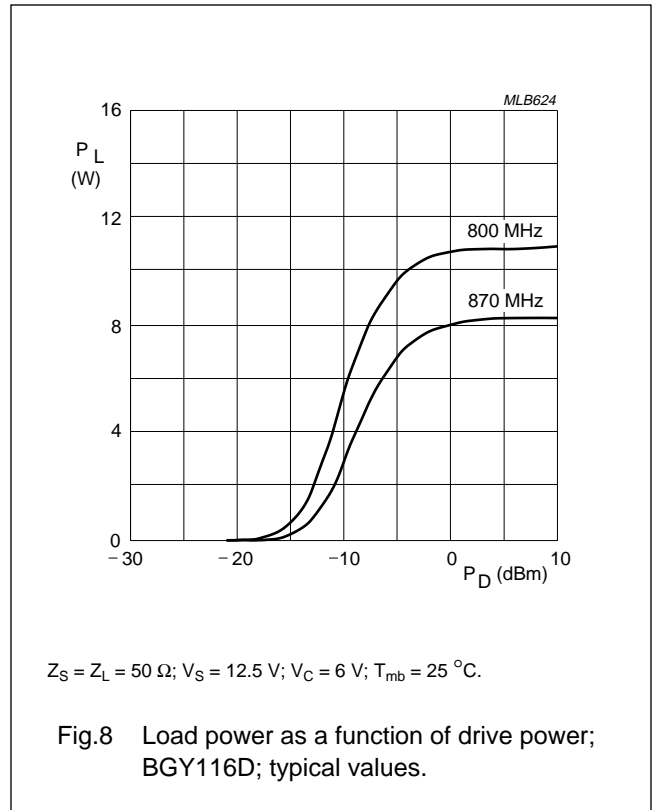
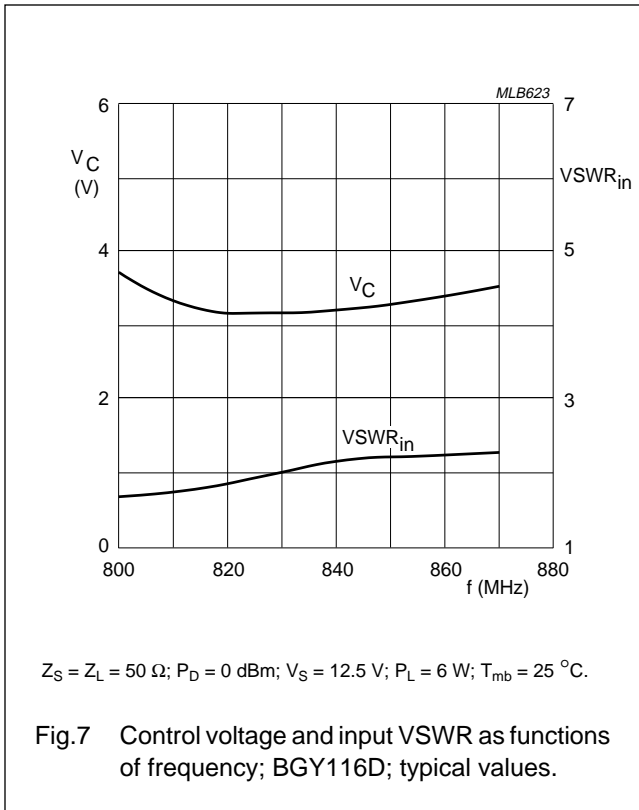

UHF amplifier modules

BGY116D; BGY116E

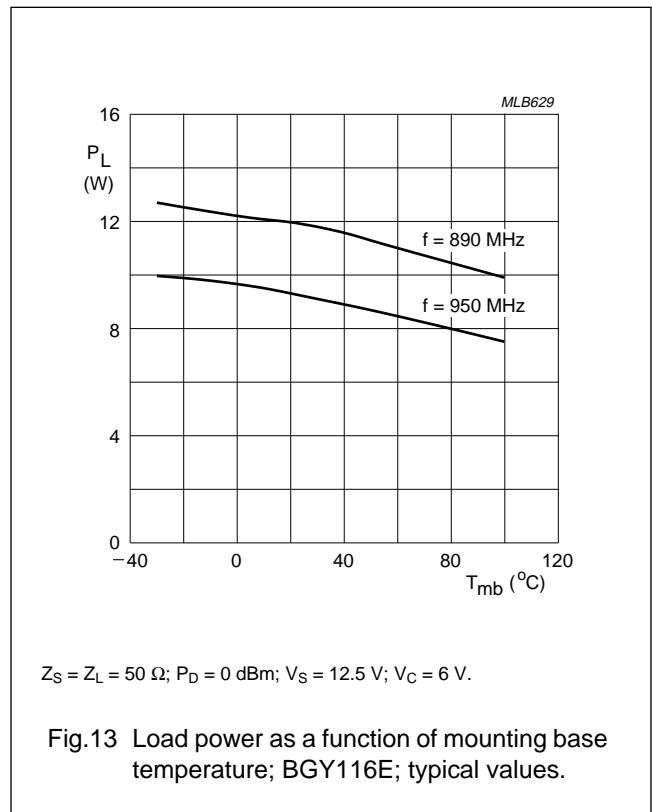
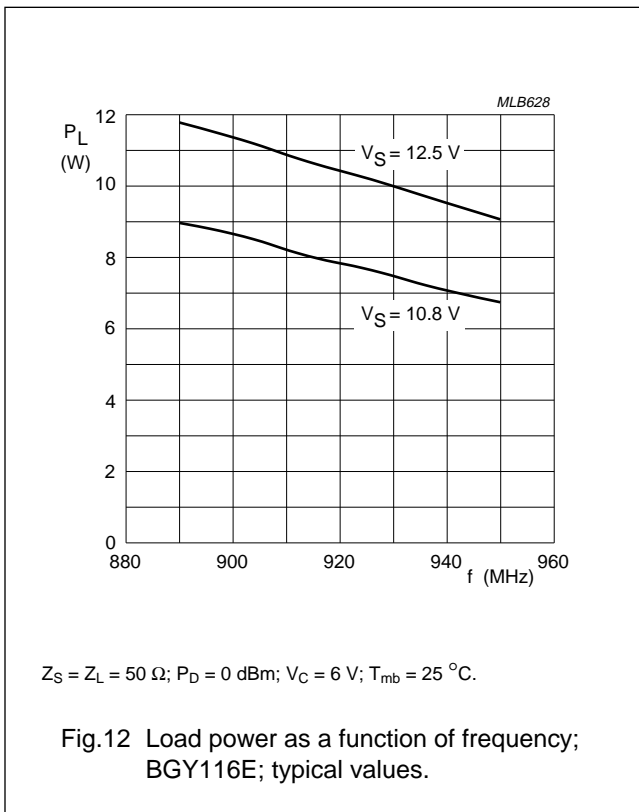
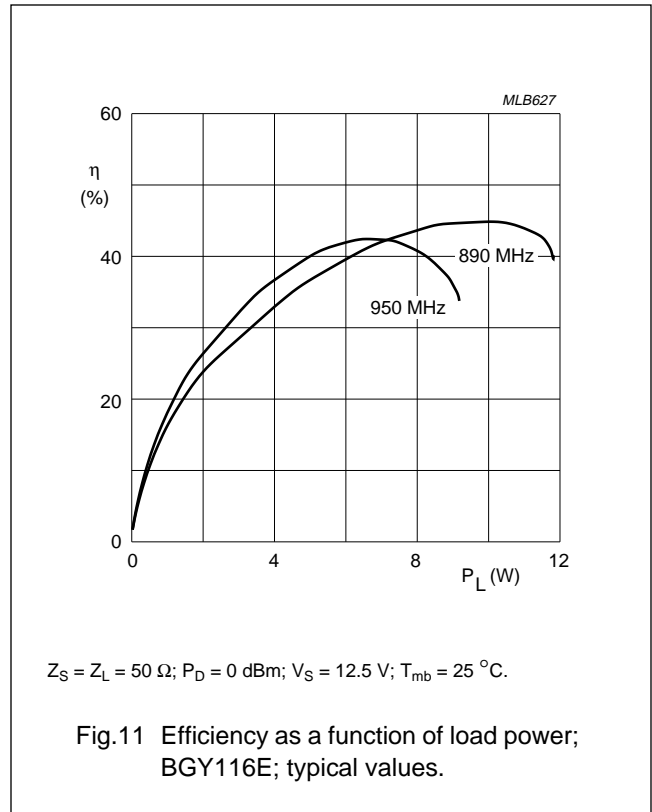
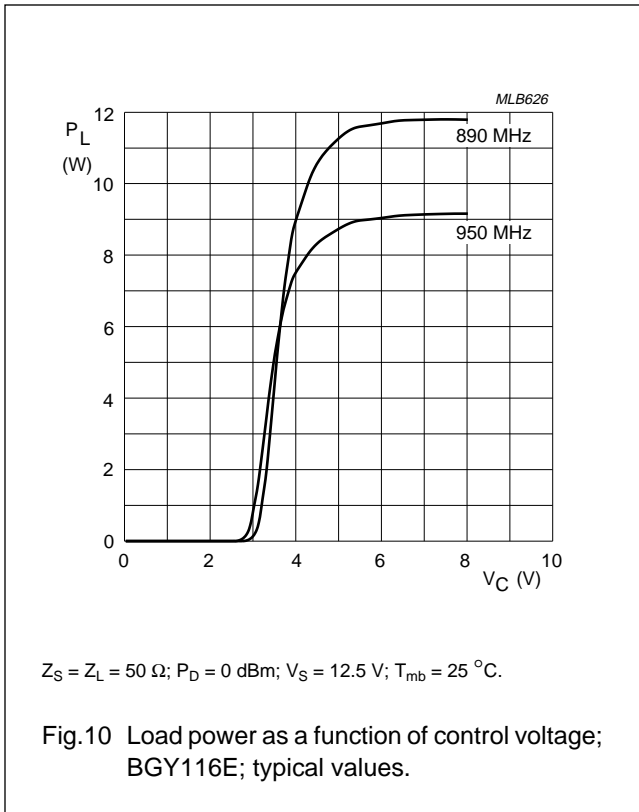

UHF amplifier modules

BGY116D; BGY116E

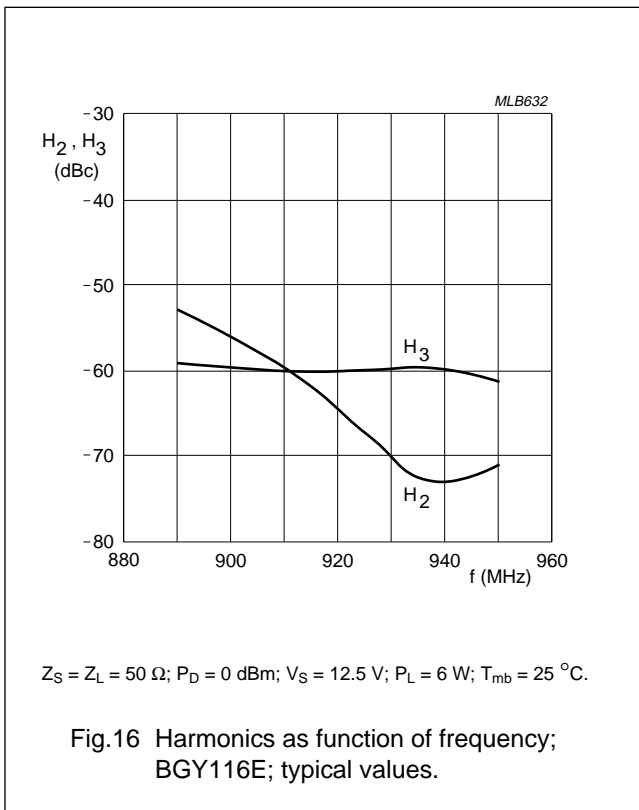
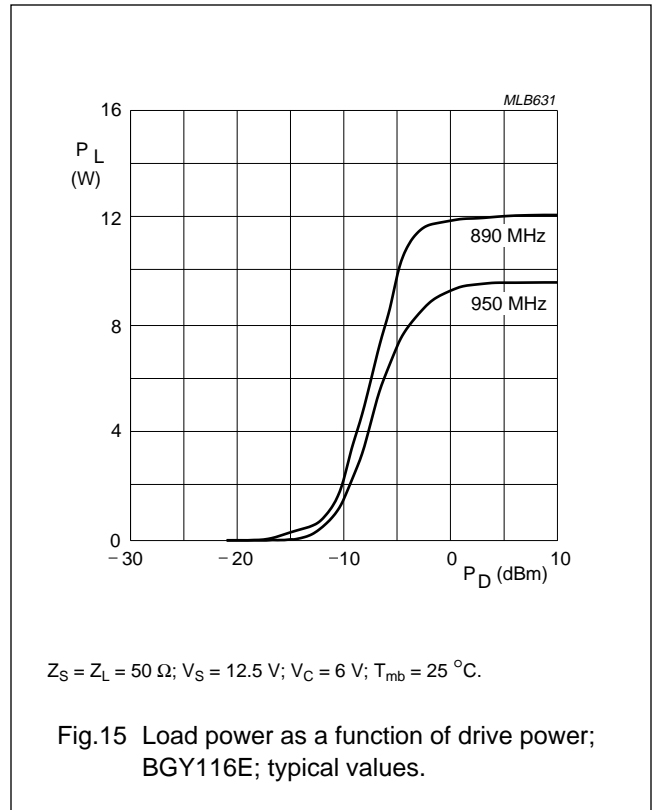
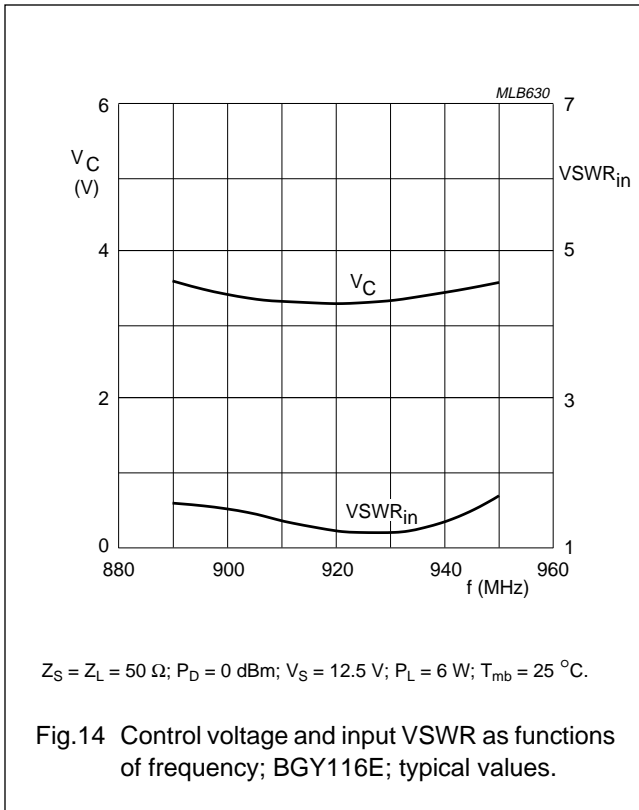



UHF amplifier modules

BGY116D; BGY116E

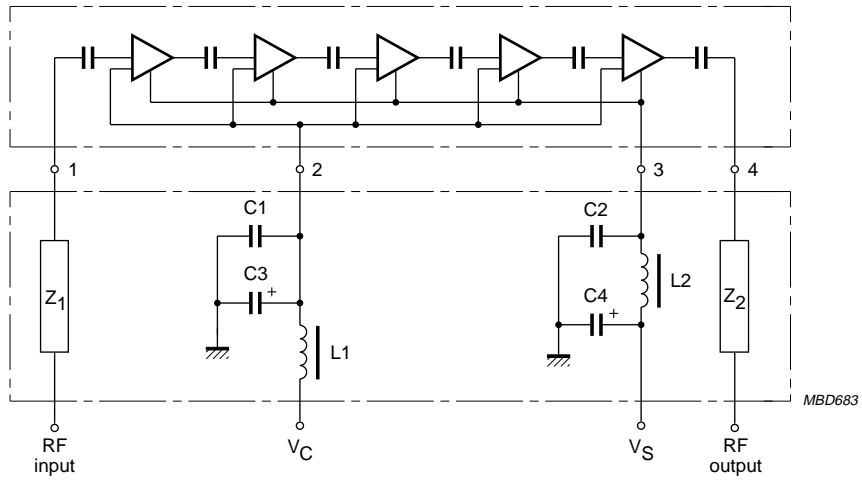
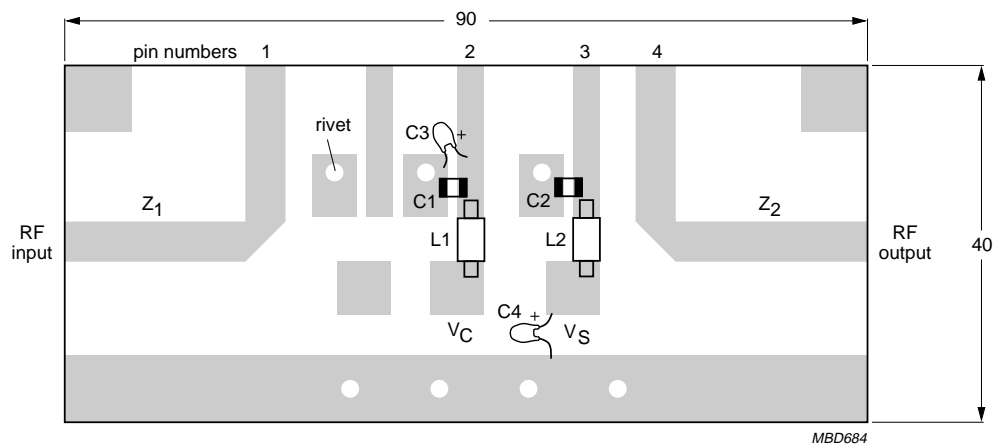

Fig.17 Test circuit.



Dimensions in mm.

Fig.18 Printed-circuit board component layout.

## UHF amplifier modules

## BGY116D; BGY116E

**List of components** (see Fig.17)

COMPONENT	DESCRIPTION	VALUE	DIMENSION	CATALOGUE NO.
C1, C2	multilayer ceramic chip capacitor	1 nF	–	–
C3, C4	tantalum capacitor	35 V; 4.7 $\mu$ F	–	–
L1, L2	micro choke	1 $\mu$ H	–	3122 108 20153
Z <sub>1</sub> , Z <sub>2</sub>	stripline; note 1	50 $\Omega$	width 4.7 mm	–

**Note**

1. The striplines are on a double copper-clad printed-circuit board with PTFE fibre-glass dielectric ( $\epsilon_r = 2.2$ ); thickness  $\frac{1}{16}$  inch.

# UHF amplifier modules

# BGY116D; BGY116E

## PACKAGE OUTLINE

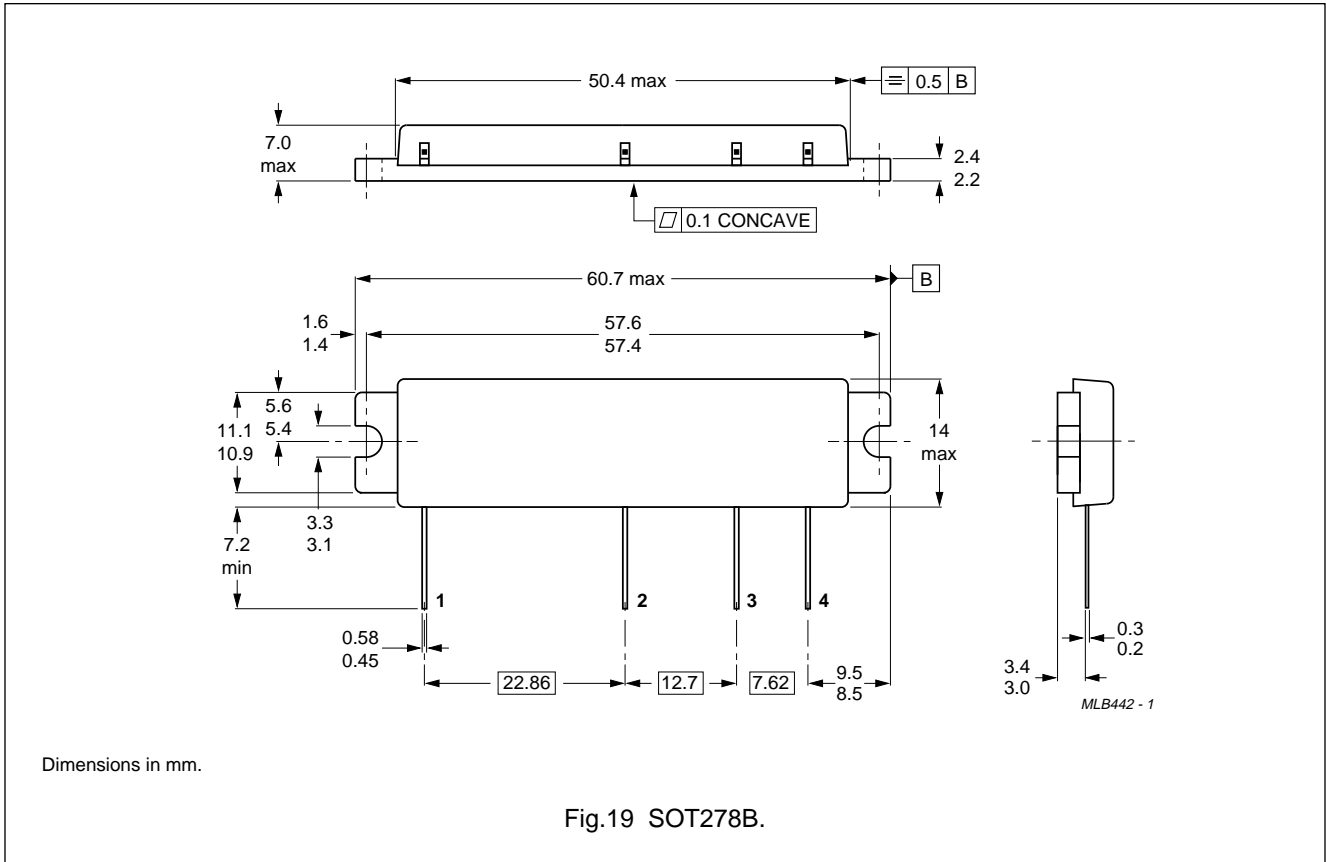

## UHF amplifier modules

## BGY116D; BGY116E

**DEFINITIONS**

<b>Data Sheet Status</b>	
Objective specification	This data sheet contains target or goal specifications for product development.
Preliminary specification	This data sheet contains preliminary data; supplementary data may be published later.
Product specification	This data sheet contains final product specifications.
<b>Limiting values</b>	
Limiting values given are in accordance with the Absolute Maximum Rating System (IEC 134). Stress above one or more of the limiting values may cause permanent damage to the device. These are stress ratings only and operation of the device at these or at any other conditions above those given in the Characteristics sections of the specification is not implied. Exposure to limiting values for extended periods may affect device reliability.	
<b>Application information</b>	
Where application information is given, it is advisory and does not form part of the specification.	

**LIFE SUPPORT APPLICATIONS**

These products are not designed for use in life support appliances, devices, or systems where malfunction of these products can reasonably be expected to result in personal injury. Philips customers using or selling these products for use in such applications do so at their own risk and agree to fully indemnify Philips for any damages resulting from such improper use or sale.