

**Rectifier diodes  
schottky barrier**

**PBYR2545CTF series**

**GENERAL DESCRIPTION**

Dual, low leakage, platinum barrier, schottky barrier rectifier diodes in a full pack, plastic envelope featuring low forward voltage drop and absence of stored charge. These devices can withstand reverse voltage transients and have guaranteed reverse surge capability. The devices are intended for use in switched mode power supplies and high frequency circuits in general where low conduction and zero switching losses are important.

**QUICK REFERENCE DATA**

SYMBOL	PARAMETER	MAX.			UNIT
		35CTF	40CTF	45CTF	
$V_{RRM}$	Repetitive peak reverse voltage	35	40	45	V
$V_F$	Forward voltage	0.65	0.65	0.65	V
$I_{O(AV)}$	Output current (both diodes conducting)	20	20	20	A

**PINNING - SOT186**

PIN	DESCRIPTION
1	anode 1 (a)
2	cathode (k)
3	anode 2 (a)

**PIN CONFIGURATION**

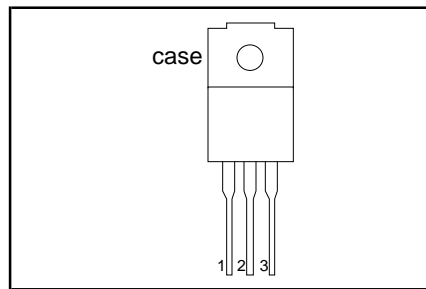

**SYMBOL**

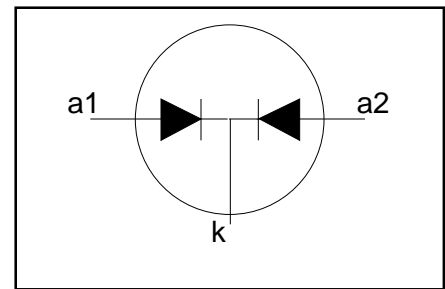

**LIMITING VALUES**

Limiting values in accordance with the Absolute Maximum System (IEC 134).

SYMBOL	PARAMETER	CONDITIONS	MIN.	MAX.			UNIT
				-35	-40	-45	
$V_{RRM}$	Repetitive peak reverse voltage	$T_{hs} \leq 111\text{ }^\circ\text{C}$	-	35	40	45	V
$V_{RWM}$	Crest working reverse voltage		-	35	40	45	V
$V_R$	Continuous reverse voltage		-	35	40	45	V
$I_{O(AV)}$	Output current (both diodes conducting)	square wave; $\delta = 0.5$ ; $T_{hs} \leq 104\text{ }^\circ\text{C}$	-	20			A
$I_{O(RMS)}$	RMS forward current	$t = 25\text{ }\mu\text{s}$ ; $\delta = 0.5$ ; $T_{hs} \leq 104\text{ }^\circ\text{C}$	-	20			A
$I_{FRM}$	Repetitive peak forward current per diode		-	20			A
$I_{FSM}$	Non-repetitive peak forward current per diode		$t = 10\text{ ms}$ $t = 8.3\text{ ms}$	-	135		
		sinusoidal; $T_j = 125\text{ }^\circ\text{C}$ prior to surge; with reapplied	-	150			A
$I^2t$	$I^2t$ for fusing	$V_{RWM(max)}$ $t = 10\text{ ms}$	-	91			$\text{A}^2\text{s}$
$I_{RRM}$	Repetitive peak reverse current per diode.	$t_p = 2\text{ }\mu\text{s}$ ; $\delta = 0.001$	-	1			A
$I_{RSM}$	Non-repetitive peak reverse current per diode.	$t_p = 100\text{ }\mu\text{s}$	-	1			A
$T_{stg}$	Storage temperature		-65	175			$^\circ\text{C}$
$T_j$	Operating junction temperature		-	150			$^\circ\text{C}$

**Rectifier diodes  
schottky barrier**
**PBYR2545CTF series**
**ISOLATION**
 $T_{hs} = 25\text{ °C}$  unless otherwise specified

SYMBOL	PARAMETER	CONDITIONS	MIN.	TYP.	MAX.	UNIT
$V_{isol}$	Repetitive peak voltage from all three terminals to external heatsink	R.H. $\leq$ 65% ; clean and dustfree	-	-	1500	V
$C_{isol}$	Capacitance from T2 to external heatsink	$f = 1\text{ MHz}$	-	12	-	pF

**THERMAL RESISTANCES**

SYMBOL	PARAMETER	CONDITIONS	MIN.	TYP.	MAX.	UNIT
$R_{th\ j-hs}$	Thermal resistance junction to heatsink	per diode both diodes (with heatsink compound)	-	-	4.8	K/W
$R_{th\ j-a}$	Thermal resistance junction to ambient	in free air.	-	55	-	K/W

**STATIC CHARACTERISTICS**
 $T_j = 25\text{ °C}$  unless otherwise stated

SYMBOL	PARAMETER	CONDITIONS	MIN.	TYP.	MAX.	UNIT
$V_F$	Forward voltage (per diode)	$I_F = 20\text{ A}$ ; $T_j = 125\text{ °C}$	-	0.58	0.65	V
$I_R$	Reverse current (per diode)	$I_F = 20\text{ A}$ $V_R = V_{RWM}$	-	0.63	0.68	V
		$V_R = V_{RWM}$ ; $T_j = 125\text{ °C}$	-	100	200	$\mu\text{A}$
$C_d$	Junction capacitance (per diode)	$f = 1\text{ MHz}$ ; $V_R = 5\text{ V}$ ; $T_j = 25\text{ °C}$ to $125\text{ °C}$	-	12	40	mA
			-	800	-	pF

Rectifier diodes  
schottky barrier

PBYR2545CTF series

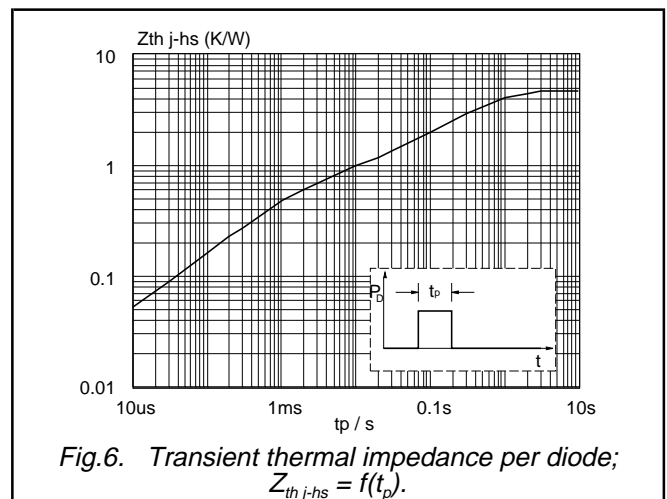
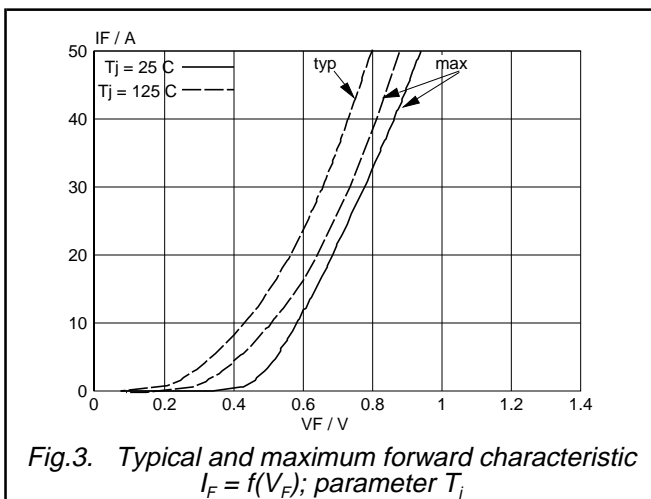
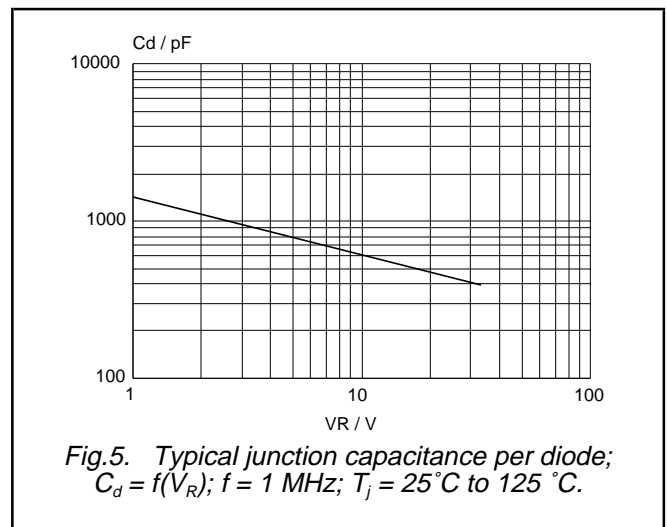
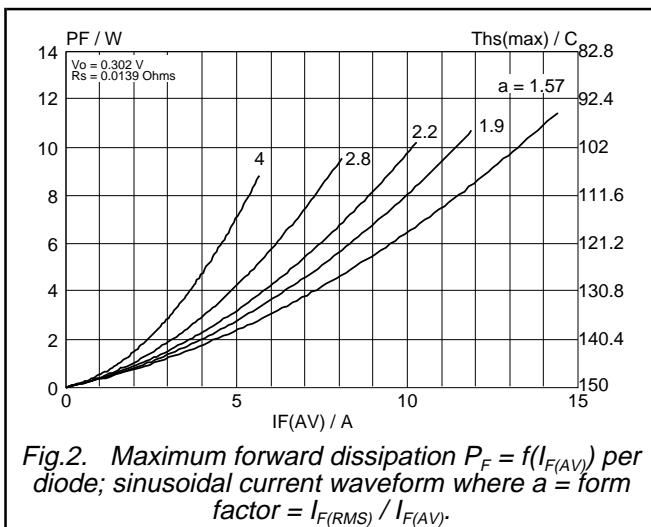
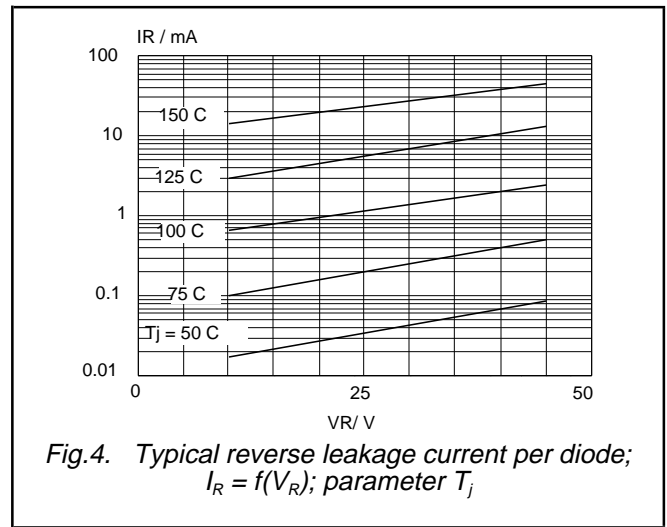
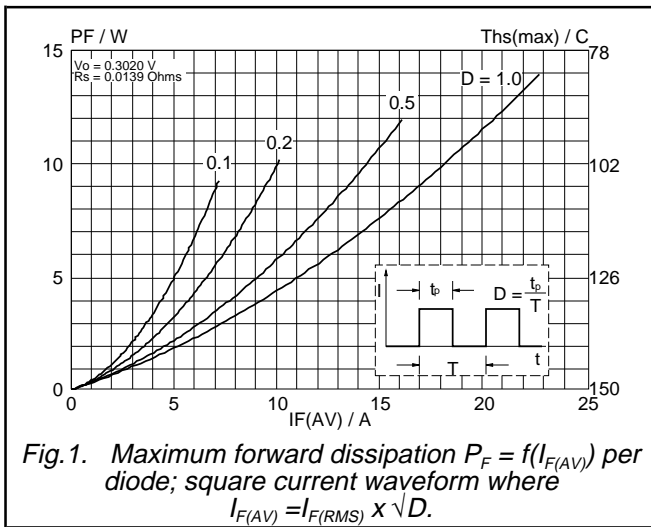

Rectifier diodes  
schottky barrier

PBYR2545CTF series

MECHANICAL DATA

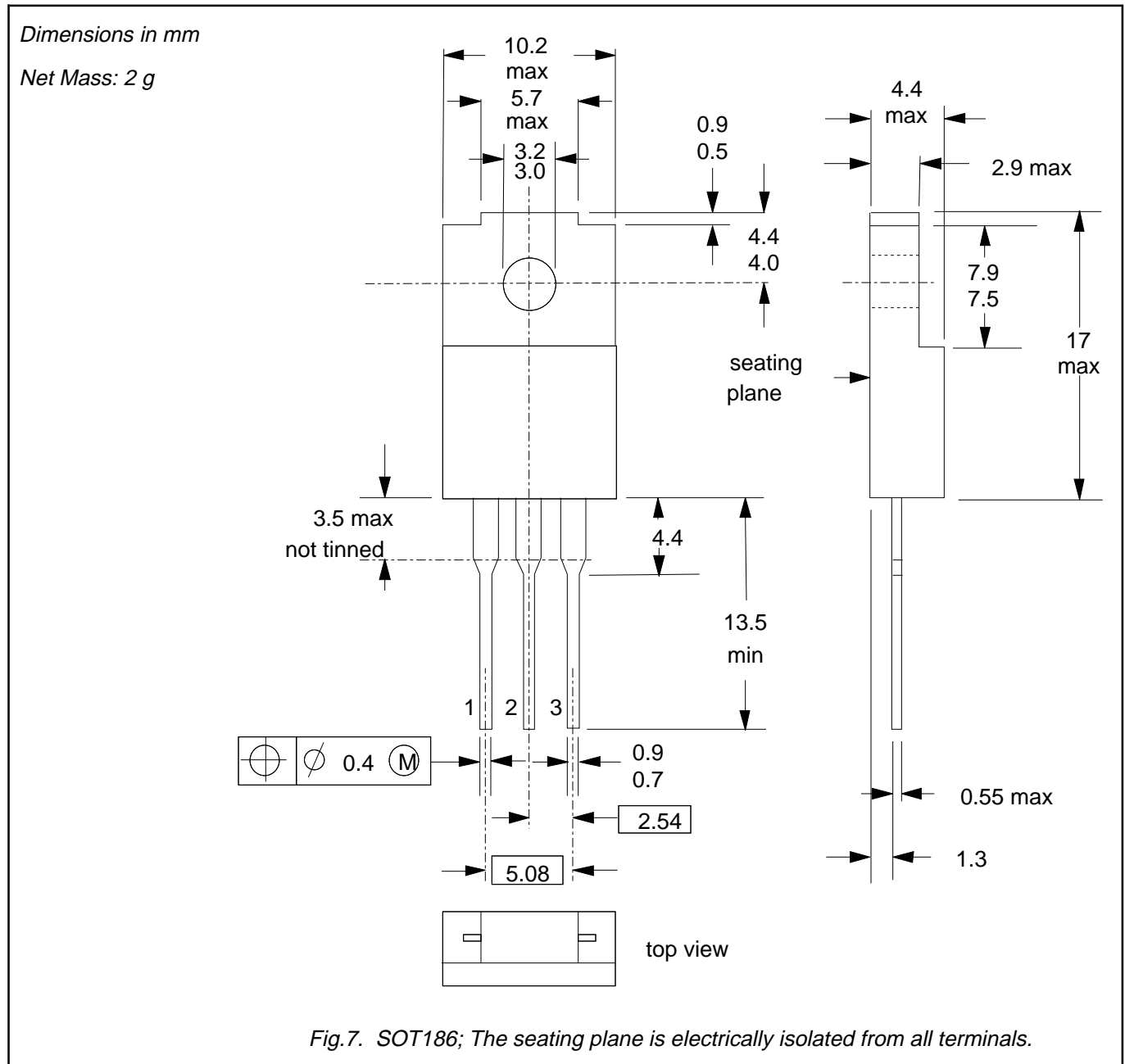

Notes

- 1. Accessories supplied on request: refer to mounting instructions for F-pack envelopes.
- 2. Epoxy meets UL94 V0 at 1/8".

---

**Rectifier diodes  
schottky barrier**

---

**PBYR2545CTF series**

---

**DEFINITIONS**

<b>Data sheet status</b>	
Objective specification	This data sheet contains target or goal specifications for product development.
Preliminary specification	This data sheet contains preliminary data; supplementary data may be published later.
Product specification	This data sheet contains final product specifications.
<b>Limiting values</b>	
Limiting values are given in accordance with the Absolute Maximum Rating System (IEC 134). Stress above one or more of the limiting values may cause permanent damage to the device. These are stress ratings only and operation of the device at these or at any other conditions above those given in the Characteristics sections of this specification is not implied. Exposure to limiting values for extended periods may affect device reliability.	
<b>Application information</b>	
Where application information is given, it is advisory and does not form part of the specification.	
<b>© Philips Electronics N.V. 1994</b>	
All rights are reserved. Reproduction in whole or in part is prohibited without the prior written consent of the copyright owner.	
The information presented in this document does not form part of any quotation or contract, it is believed to be accurate and reliable and may be changed without notice. No liability will be accepted by the publisher for any consequence of its use. Publication thereof does not convey nor imply any license under patent or other industrial or intellectual property rights.	

**LIFE SUPPORT APPLICATIONS**

These products are not designed for use in life support appliances, devices or systems where malfunction of these products can be reasonably expected to result in personal injury. Philips customers using or selling these products for use in such applications do so at their own risk and agree to fully indemnify Philips for any damages resulting from such improper use or sale.