

**Rectifier diodes
schottky barrier**

PBYR1545CTF series

GENERAL DESCRIPTION

Dual, low leakage, platinum barrier, schottky barrier rectifier diodes in a full pack, plastic envelope featuring low forward voltage drop and absence of stored charge. These devices can withstand reverse voltage transients and have guaranteed reverse surge capability. The devices are intended for use in switched mode power supplies and high frequency circuits in general where low conduction and zero switching losses are important.

QUICK REFERENCE DATA

SYMBOL	PARAMETER	MAX.			UNIT
		35CTF	40CTF	45CTF	
V_{RRM}	Repetitive peak reverse voltage	35	40	45	V
V_F	Forward voltage	0.57	0.57	0.57	V
$I_{O(AV)}$	Output current (both diodes conducting)	15	15	15	A

PINNING - SOT186

PIN	DESCRIPTION
1	anode 1 (a)
2	cathode (k)
3	anode 2 (a)

PIN CONFIGURATION

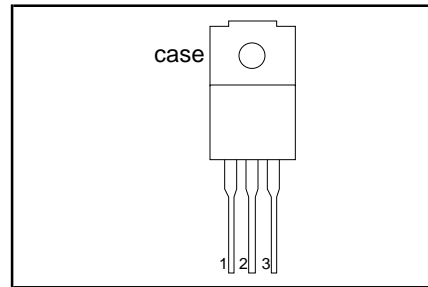

SYMBOL

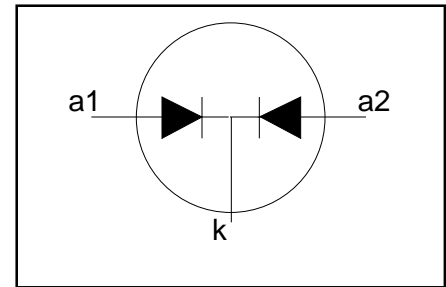

LIMITING VALUES

Limiting values in accordance with the Absolute Maximum System (IEC 134).

SYMBOL	PARAMETER	CONDITIONS	MIN.	MAX.			UNIT
				-35	-40	-45	
V_{RRM}	Repetitive peak reverse voltage	$T_{hs} \leq 117\text{ }^\circ\text{C}$	-	35	40	45	V
V_{RWM}	Crest working reverse voltage		-	35	40	45	V
V_R	Continuous reverse voltage		-	35	40	45	V
$I_{O(AV)}$	Output current) both diodes conducting)	square wave; $\delta = 0.5$; $T_{hs} \leq 100\text{ }^\circ\text{C}$	-	15			A
$I_{O(RMS)}$	RMS forward current	$t = 25\text{ }\mu\text{s}$; $\delta = 0.5$; $T_{hs} \leq 100\text{ }^\circ\text{C}$	-	21			A
I_{FRM}	Repetitive peak forward current per diode		-	15			A
I_{FSM}	Non-repetitive peak forward current per diode.		$t = 10\text{ ms}$ $t = 8.3\text{ ms}$ sinusoidal; $T_j = 125\text{ }^\circ\text{C}$ prior to surge; with reapplied	-	100		
I^2t	I^2t for fusing	$V_{RWM(max)}$ $t = 10\text{ ms}$	-	50			A^2s
I_{RRM}	Repetitive peak reverse current per diode.	$t_p = 2\text{ }\mu\text{s}$; $\delta = 0.001$	-	1			A
I_{RSM}	Non-repetitive peak reverse current per diode.	$t_p = 100\text{ }\mu\text{s}$	-	1			A
T_{stg}	Storage temperature		-65	175			$^\circ\text{C}$
T_j	Operating junction temperature		-	150			$^\circ\text{C}$

**Rectifier diodes
schottky barrier**
PBYR1545CTF series
ISOLATION
 $T_{hs} = 25\text{ °C}$ unless otherwise specified

SYMBOL	PARAMETER	CONDITIONS	MIN.	TYP.	MAX.	UNIT
V_{isol}	Repetitive peak voltage from all three terminals to external heatsink	R.H. $\leq 65\%$; clean and dustfree	-	-	1500	V
C_{isol}	Capacitance from T2 to external heatsink	$f = 1\text{ MHz}$	-	12	-	pF

THERMAL RESISTANCES

SYMBOL	PARAMETER	CONDITIONS	MIN.	TYP.	MAX.	UNIT
$R_{th\ j-hs}$	Thermal resistance junction to heatsink	per diode both diodes (with heatsink compound)	-	-	6.1	K/W
$R_{th\ j-a}$	Thermal resistance junction to ambient	in free air.	-	55	-	K/W

STATIC CHARACTERISTICS
 $T_j = 25\text{ °C}$ unless otherwise stated

SYMBOL	PARAMETER	CONDITIONS	MIN.	TYP.	MAX.	UNIT
V_F	Forward voltage (per diode)	$I_F = 7.5\text{ A}; T_j = 125\text{ °C}$ $I_F = 15\text{ A}; T_j = 125\text{ °C}$	-	0.50	0.57	V
		$I_F = 15\text{ A}$	-	0.62	0.72	V
I_R	Reverse current (per diode)	$V_R = V_{RWM}$	-	50	100	μA
		$V_R = V_{RWM}; T_j = 125\text{ °C}$	-	12	22	mA
C_d	Junction capacitance (per diode)	$f = 1\text{ MHz}; V_R = 5\text{ V}; T_j = 25\text{ °C to } 125\text{ °C}$	-	350	-	pF

Rectifier diodes
schottky barrier

PBYR1545CTF series

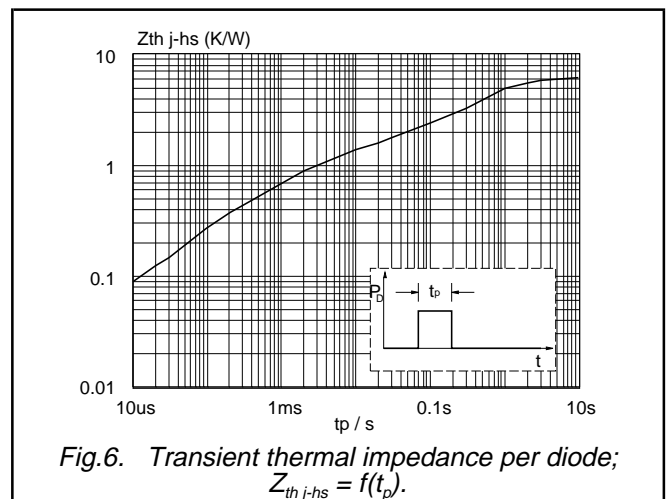
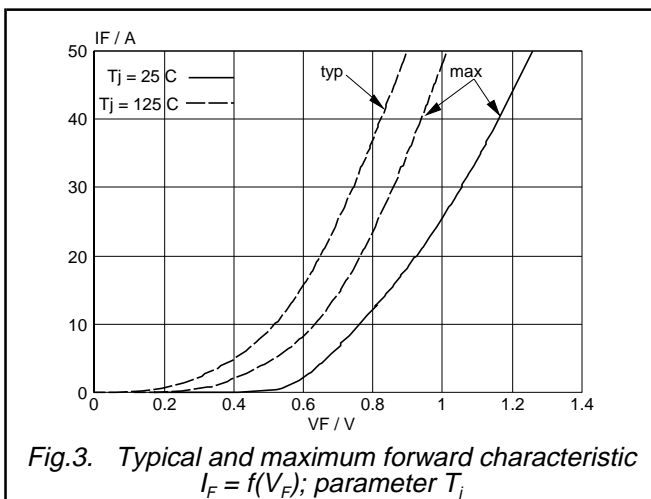
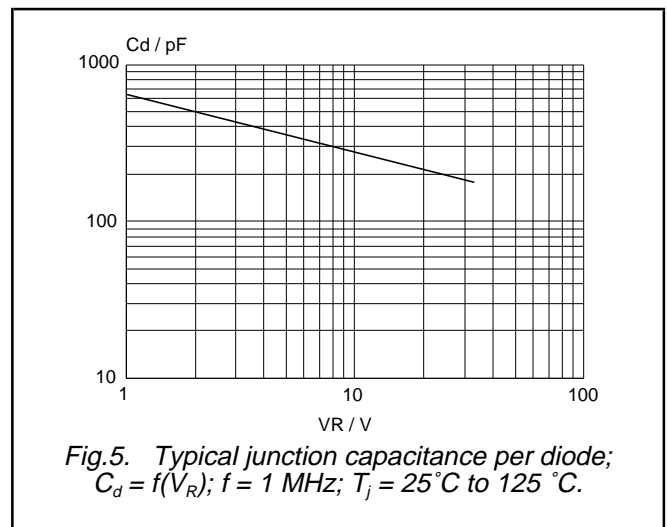
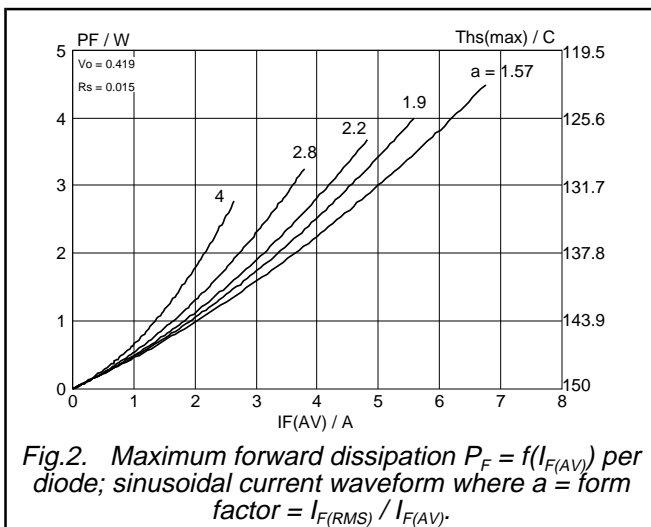
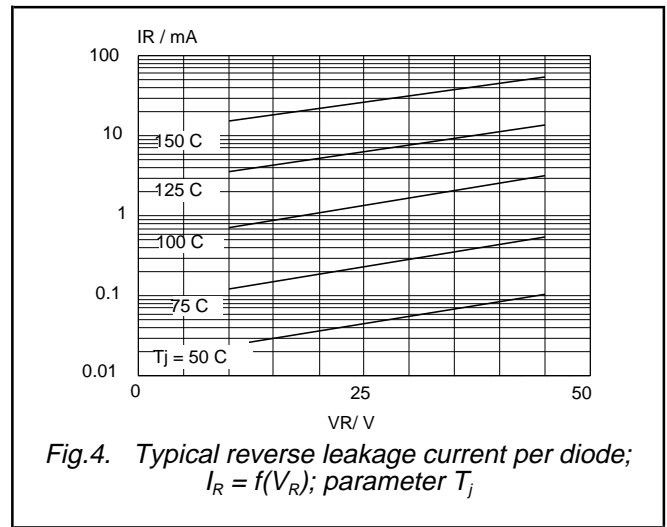
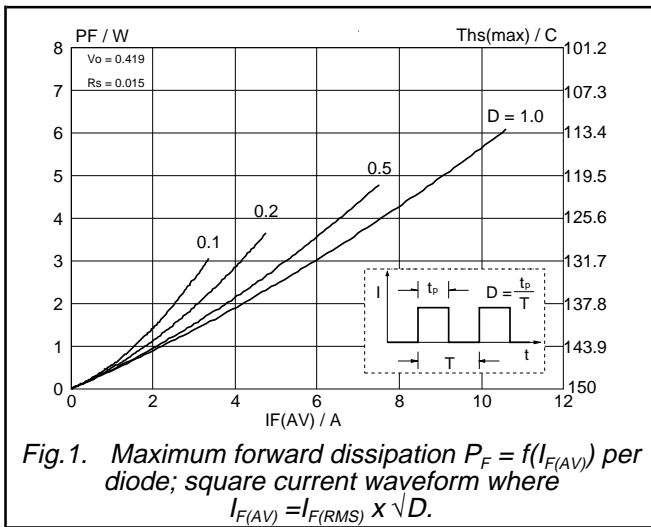

Rectifier diodes
schottky barrier

PBYR1545CTF series

MECHANICAL DATA

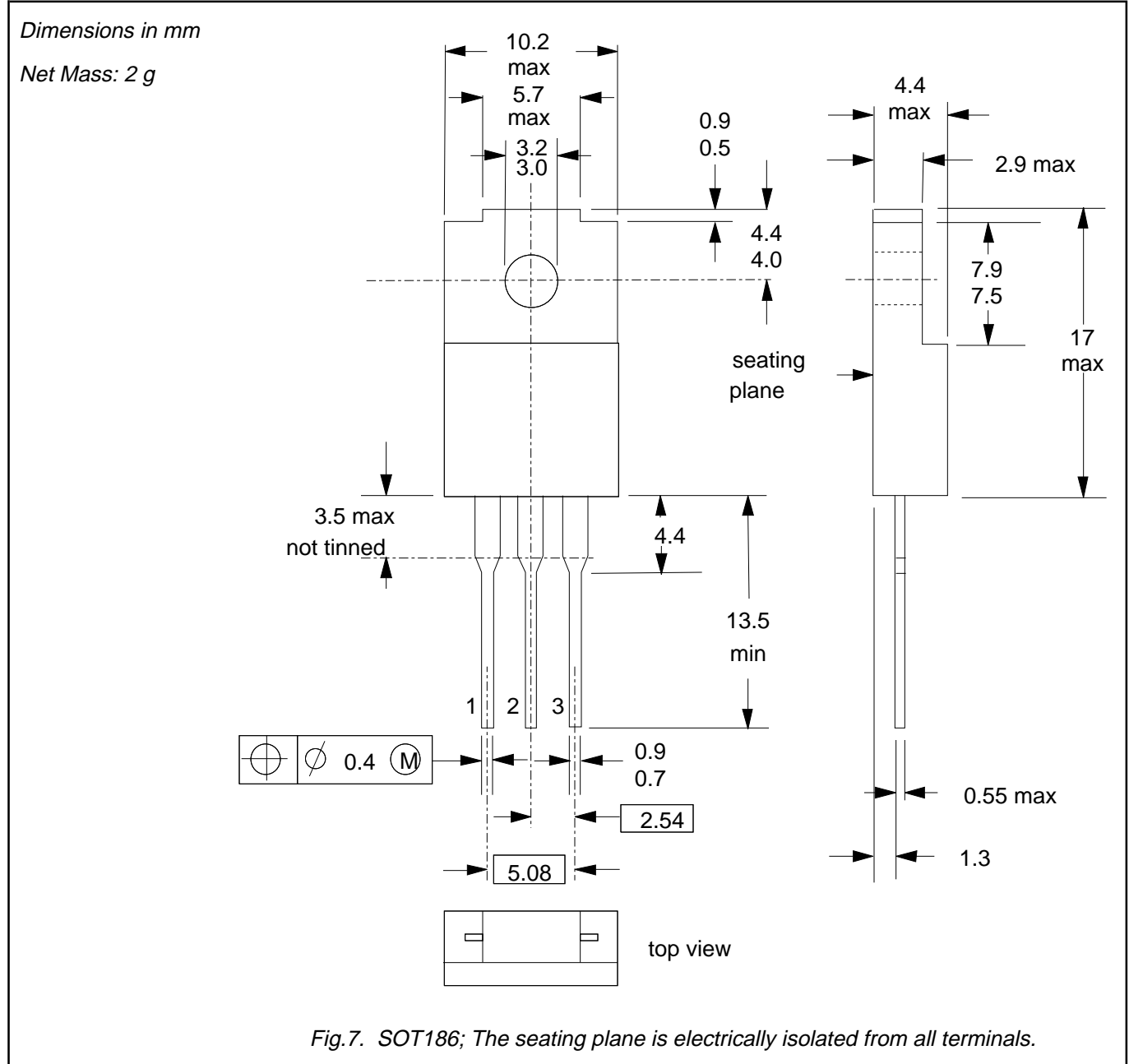

Notes

- 1. Accessories supplied on request: refer to mounting instructions for F-pack envelopes.
- 2. Epoxy meets UL94 V0 at 1/8".

**Rectifier diodes
schottky barrier**

PBYR1545CTF series

DEFINITIONS

Data sheet status	
Objective specification	This data sheet contains target or goal specifications for product development.
Preliminary specification	This data sheet contains preliminary data; supplementary data may be published later.
Product specification	This data sheet contains final product specifications.
Limiting values	
Limiting values are given in accordance with the Absolute Maximum Rating System (IEC 134). Stress above one or more of the limiting values may cause permanent damage to the device. These are stress ratings only and operation of the device at these or at any other conditions above those given in the Characteristics sections of this specification is not implied. Exposure to limiting values for extended periods may affect device reliability.	
Application information	
Where application information is given, it is advisory and does not form part of the specification.	
© Philips Electronics N.V. 1994	
All rights are reserved. Reproduction in whole or in part is prohibited without the prior written consent of the copyright owner.	
The information presented in this document does not form part of any quotation or contract, it is believed to be accurate and reliable and may be changed without notice. No liability will be accepted by the publisher for any consequence of its use. Publication thereof does not convey nor imply any license under patent or other industrial or intellectual property rights.	

LIFE SUPPORT APPLICATIONS

These products are not designed for use in life support appliances, devices or systems where malfunction of these products can be reasonably expected to result in personal injury. Philips customers using or selling these products for use in such applications do so at their own risk and agree to fully indemnify Philips for any damages resulting from such improper use or sale.