

DATA SHEET

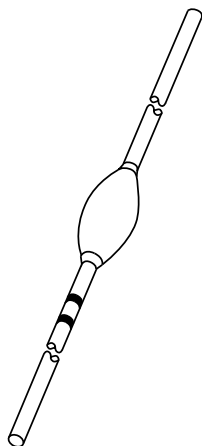

BY8000 series

Fast high-voltage soft-recovery
controlled avalanche rectifiers

Product specification
Supersedes data of June 1994
File under Discrete Semiconductors, SC01

1996 May 24

Fast high-voltage soft-recovery controlled avalanche rectifiers

BY8000 series

FEATURES

- Glass passivated
- High maximum operating temperature
- Low leakage current
- Excellent stability
- Guaranteed avalanche energy absorption capability
- Soft-recovery switching characteristics
- Compact construction.

APPLICATIONS

- For colour television and monitors up to 25 kHz
- High-voltage applications for:
 - Multipliers
 - Layer-wound diode-split-transformers where controlled avalanche is required.

DESCRIPTION

Rugged glass package, using a high temperature alloyed construction. This package is hermetically sealed and fatigue free as coefficients of

expansion of all used parts are matched.

The package is designed to be used in an insulating medium such as resin, oil or SF6 gas.

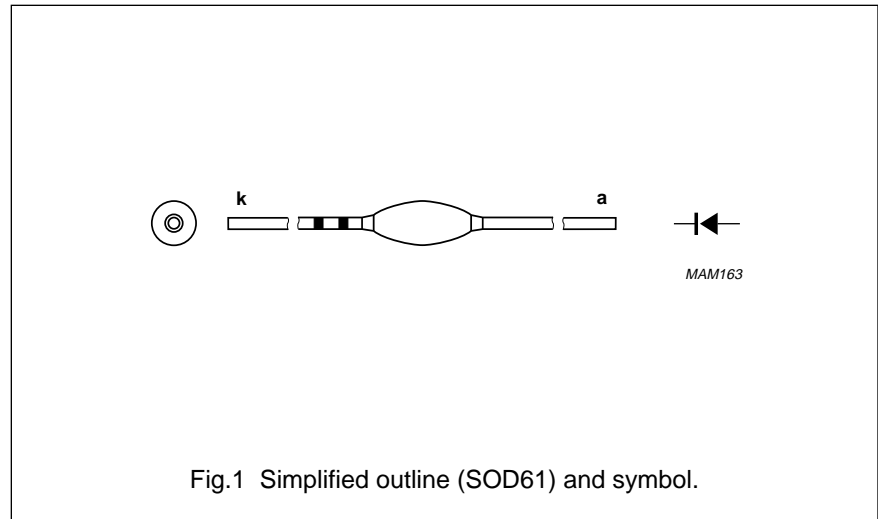

MARKING

Cathode band colour codes

TYPE NUMBER	PACKAGE CODE	INNER BAND	OUTER BAND
BY8004	SOD61AC	violet	black
BY8006	SOD61AD	violet	green
BY8008	SOD61AE	violet	red
BY8010	SOD61AF	violet	violet
BY8012	SOD61AH	violet	orange
BY8014	SOD61AI	violet	lilac
BY8016	SOD61AJ	violet	grey

Fast high-voltage soft-recovery controlled avalanche rectifiers

BY8000 series

LIMITING VALUES

In accordance with the Absolute Maximum Rating System (IEC 134).

SYMBOL	PARAMETER	CONDITIONS	MIN.	MAX.	UNIT	
V _{RRM}	repetitive peak reverse voltage					
	BY8004		–	5	kV	
	BY8006		–	8	kV	
	BY8008		–	10	kV	
	BY8010		–	12	kV	
	BY8012		–	14	kV	
	BY8014		–	17	kV	
V _{RW}	working reverse voltage					
	BY8004		–	4	kV	
	BY8006		–	6	kV	
	BY8008		–	8	kV	
	BY8010		–	10	kV	
	BY8012		–	12	kV	
	BY8014		–	14	kV	
I _{F(AV)}	average forward current	averaged over any 20 ms period; see Figs 2 to 8				
	BY8004		–	20	mA	
	BY8006		–	10	mA	
	BY8008		–	5	mA	
	BY8010		–	5	mA	
	BY8012		–	5	mA	
	BY8014		–	5	mA	
I _{FRM}	repetitive peak forward current	note 1	–	500	mA	
	P _{RSM}	non-repetitive peak reverse power dissipation	t = 20 μs half sinewave; T _j = T _{j max} prior to surge			
		BY8004		–	2.5	kW
		BY8006		–	3.5	kW
		BY8008		–	4.2	kW
		BY8010		–	5.2	kW
		BY8012		–	7.0	kW
BY8014			–	7.8	kW	
T _{stg}	storage temperature		–65	+120	°C	
	T _j	junction temperature	–65	+120	°C	

Note

1. Withstands peak currents during flash-over in a picture tube.

Fast high-voltage soft-recovery controlled avalanche rectifiers

BY8000 series

ELECTRICAL CHARACTERISTICS

$T_j = 25\text{ °C}$; unless otherwise specified.

SYMBOL	PARAMETER	CONDITIONS	MIN.	TYP.	MAX.	UNIT
V_F	forward voltage	$I_F = 100\text{ mA}$; $T_j = T_{j\text{ max}}$; see Figs 9 to 15	-	-	20	V
	BY8004					
	BY8006					
	BY8008					
	BY8010					
	BY8012					
	BY8014					
BY8016						
I_R	reverse current	$V_R = V_{RW\text{max}}$; $T_j = 120\text{ °C}$	-	-	3	μA
Q_r	recovery charge	when switched from $I_F = 100\text{ mA}$ to $V_R \geq 100\text{ V}$ and $dI_F/dt = -200\text{ mA}/\mu\text{s}$; see Fig.16	-	-	1	nC
t_f	fall time	when switched from $I_F = 100\text{ mA}$ to $V_R \geq 100\text{ V}$ and $dI_F/dt = -200\text{ mA}/\mu\text{s}$; see Fig.16	80	-	-	ns
t_{rr}	reverse recovery time	when switched from $I_F = 2\text{ mA}$ to $I_R = 4\text{ mA}$; measured at $I_R = 1\text{ mA}$; see Fig.17	-	-	100	ns
C_d	diode capacitance	$V_R = 0\text{ V}$; $f = 1\text{ MHz}$	-	0.90	-	pF
	BY8004					
	BY8006					
	BY8008					
	BY8010					
	BY8012					
	BY8014					
BY8016						

Fast high-voltage soft-recovery controlled avalanche rectifiers

BY8000 series

GRAPHICAL DATA

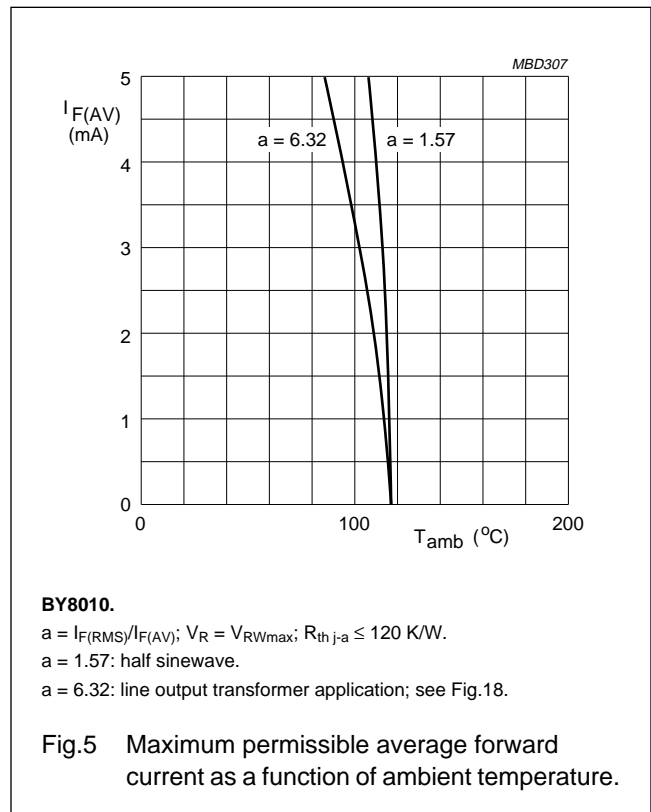
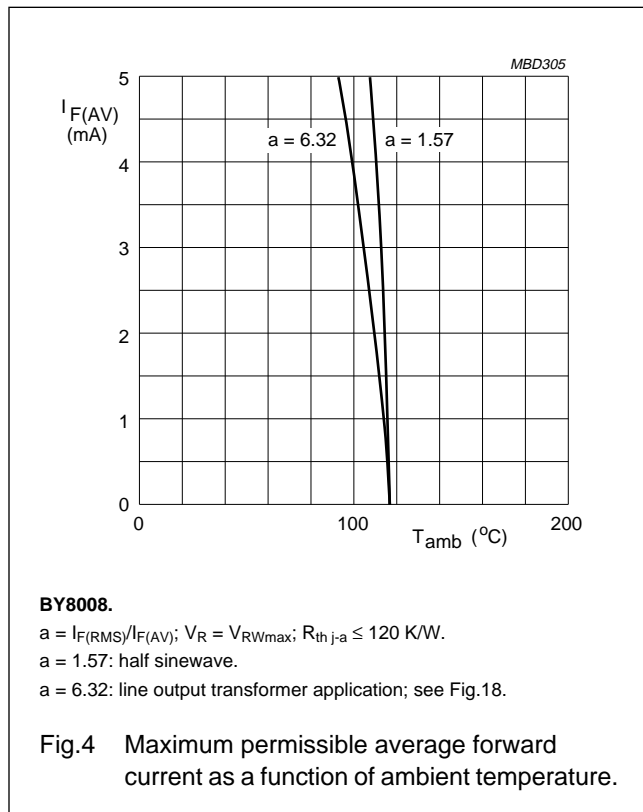
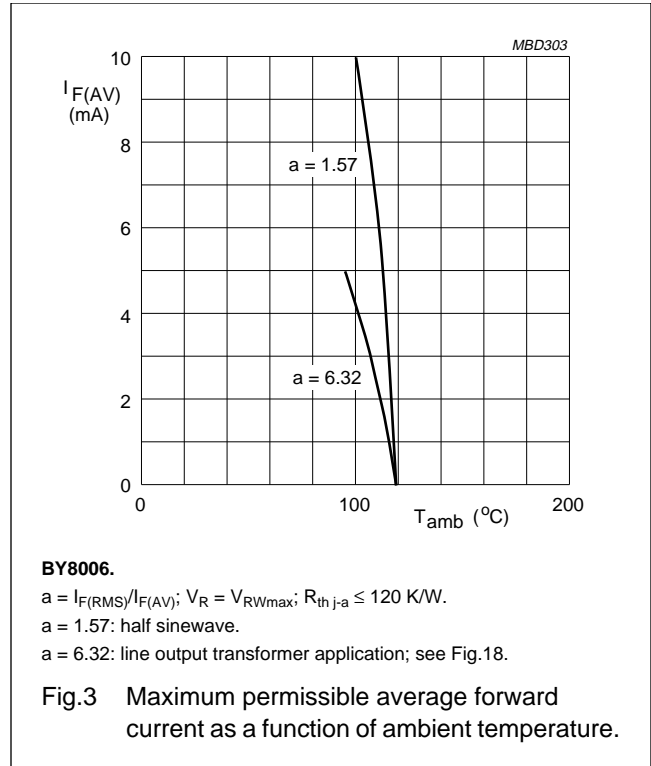
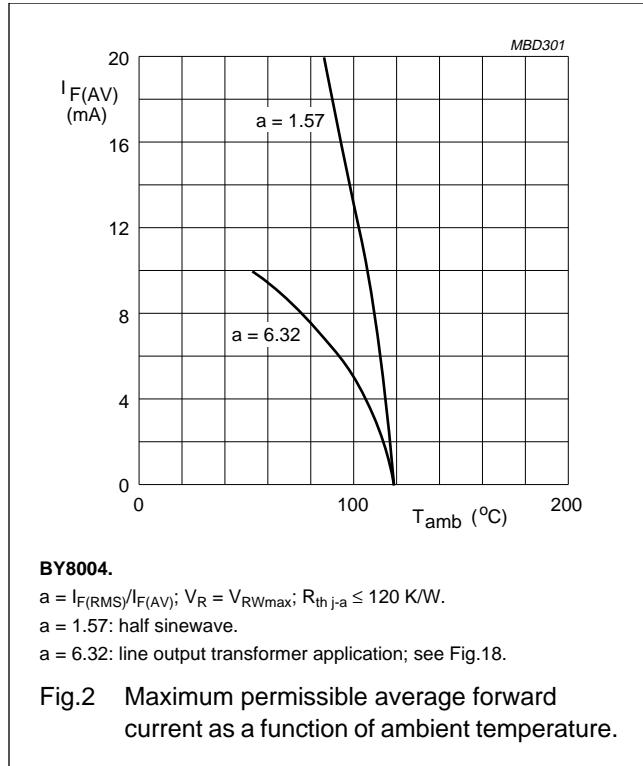

Fast high-voltage soft-recovery controlled avalanche rectifiers

BY8000 series

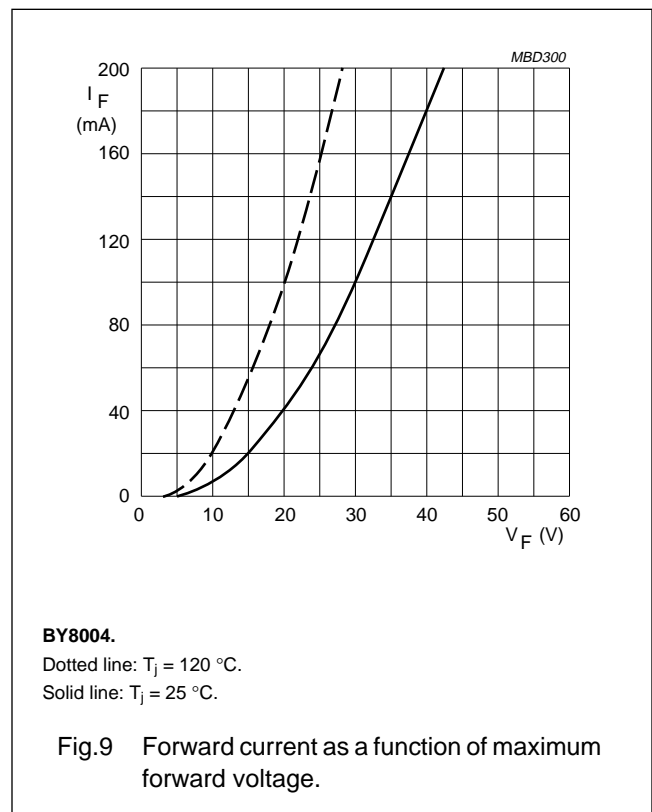
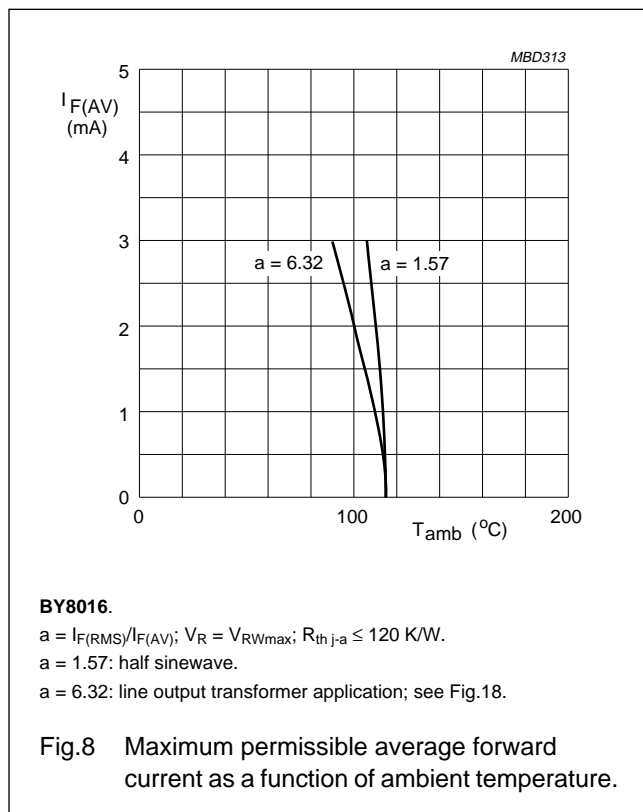
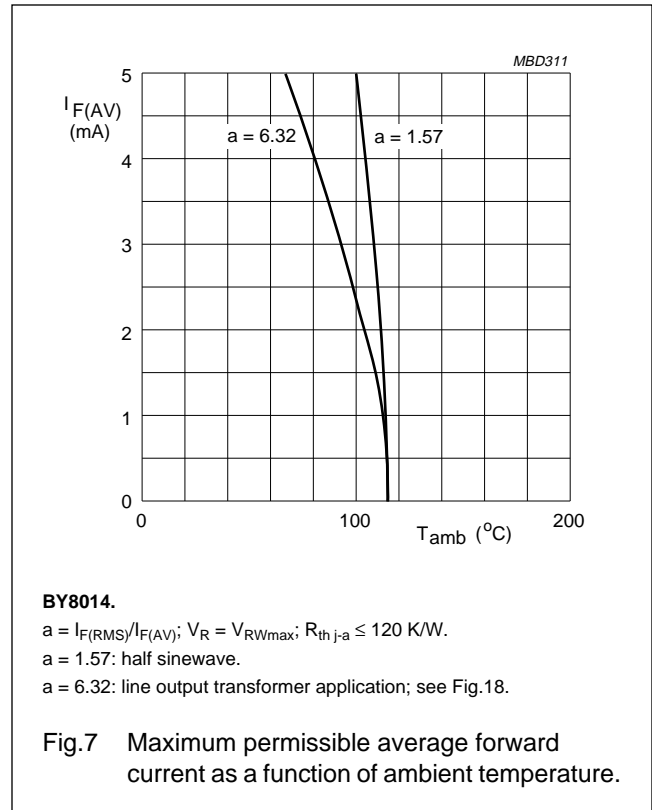
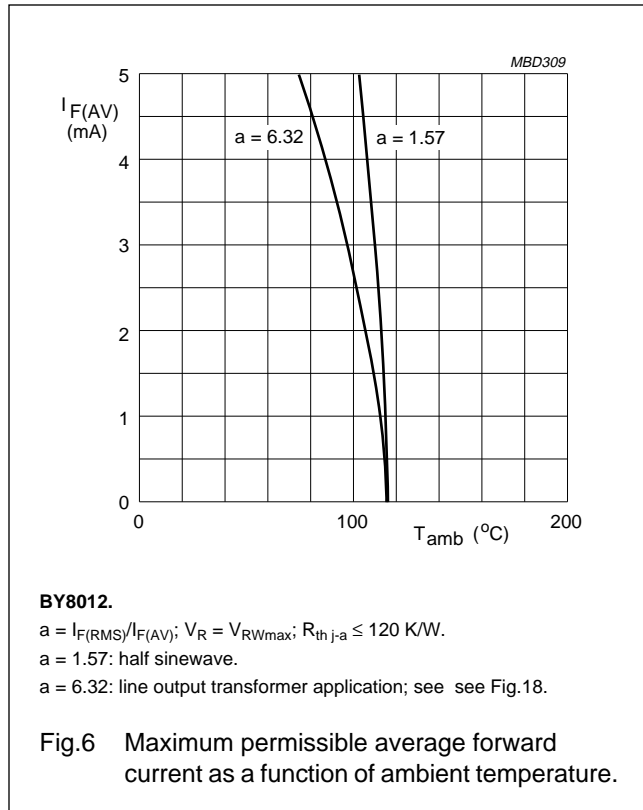

Fast high-voltage soft-recovery controlled avalanche rectifiers

BY8000 series

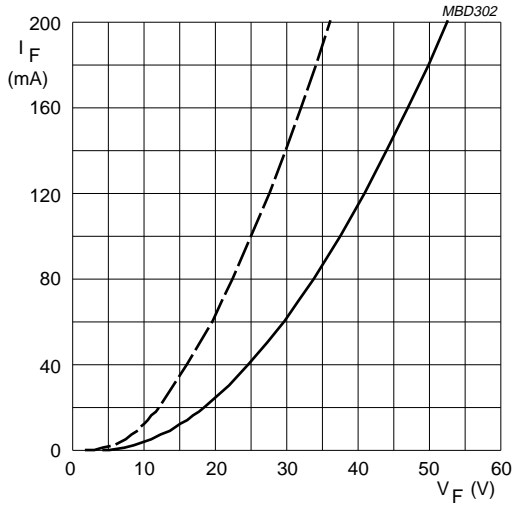

BY8006.
Dotted line: $T_j = 120\text{ }^\circ\text{C}$.
Solid line: $T_j = 25\text{ }^\circ\text{C}$.

Fig. 10 Forward current as a function of maximum forward voltage.

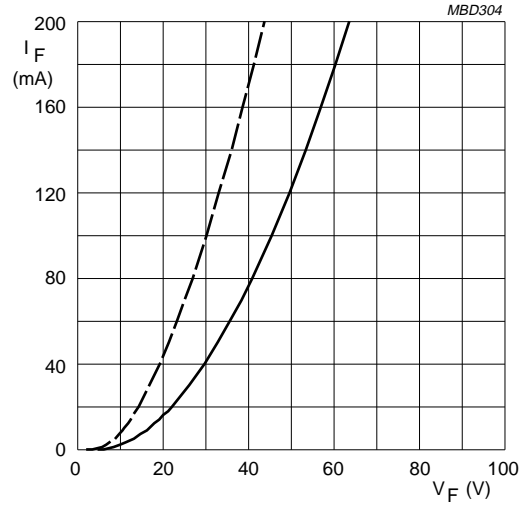

BY8008.
Dotted line: $T_j = 120\text{ }^\circ\text{C}$.
Solid line: $T_j = 25\text{ }^\circ\text{C}$.

Fig. 11 Forward current as a function of maximum forward voltage.

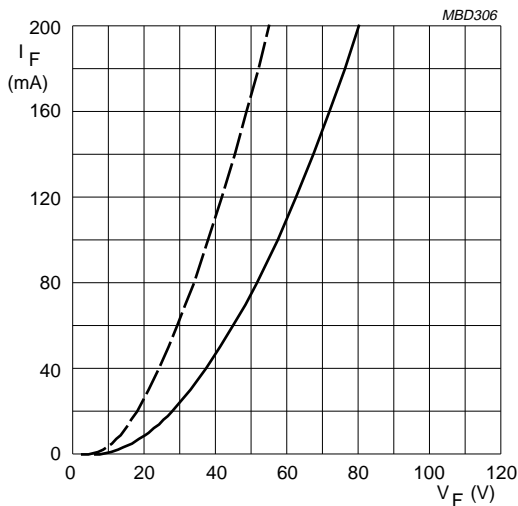

BY8010.
Dotted line: $T_j = 120\text{ }^\circ\text{C}$.
Solid line: $T_j = 25\text{ }^\circ\text{C}$.

Fig. 12 Forward current as a function of maximum forward voltage.

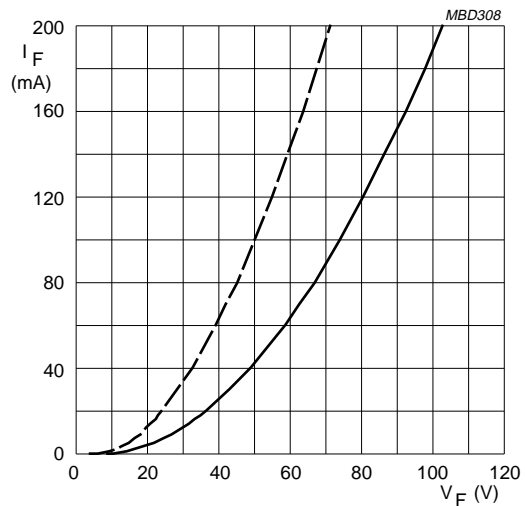

BY8012.
Dotted line: $T_j = 120\text{ }^\circ\text{C}$.
Solid line: $T_j = 25\text{ }^\circ\text{C}$.

Fig. 13 Forward current as a function of maximum forward voltage.

Fast high-voltage soft-recovery controlled avalanche rectifiers

BY8000 series

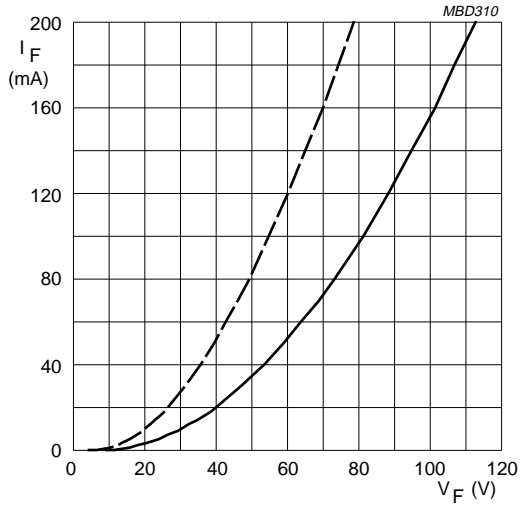

BY8014.
Dotted line: $T_j = 120\text{ }^\circ\text{C}$.
Solid line: $T_j = 25\text{ }^\circ\text{C}$.

Fig.14 Forward current as a function of maximum forward voltage.

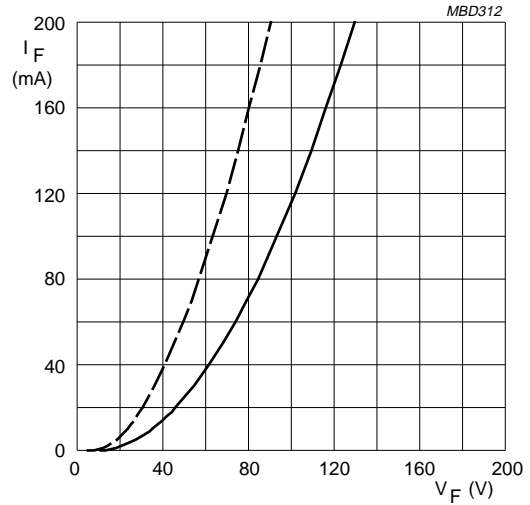

BY8016.
Dotted line: $T_j = 120\text{ }^\circ\text{C}$.
Solid line: $T_j = 25\text{ }^\circ\text{C}$.

Fig.15 Forward current as a function of maximum forward voltage.

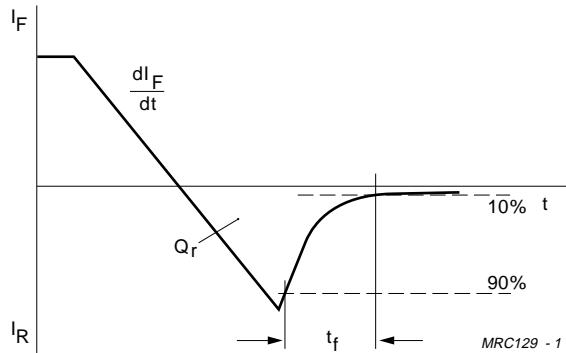
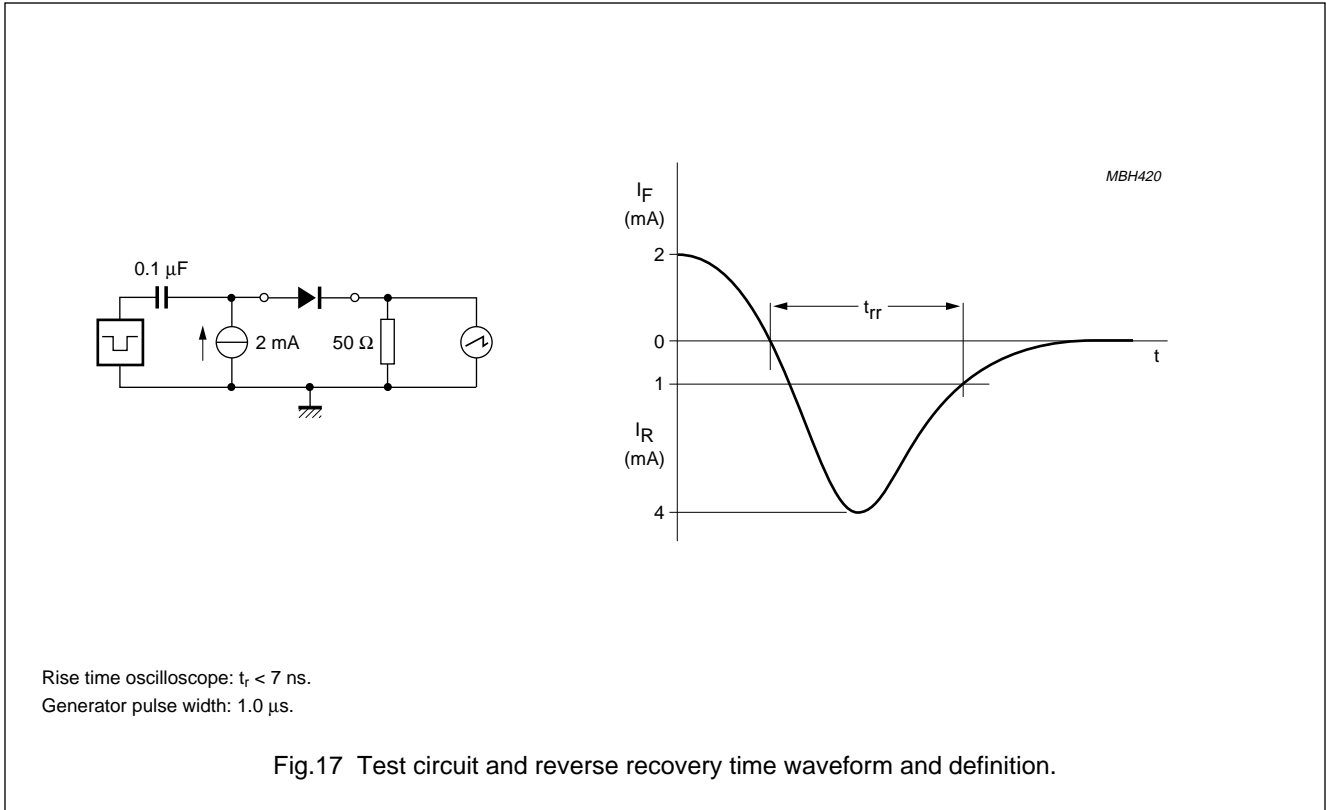

Fig.16 Reverse recovery definitions.

Fast high-voltage soft-recovery controlled avalanche rectifiers

BY8000 series



APPLICATION INFORMATION

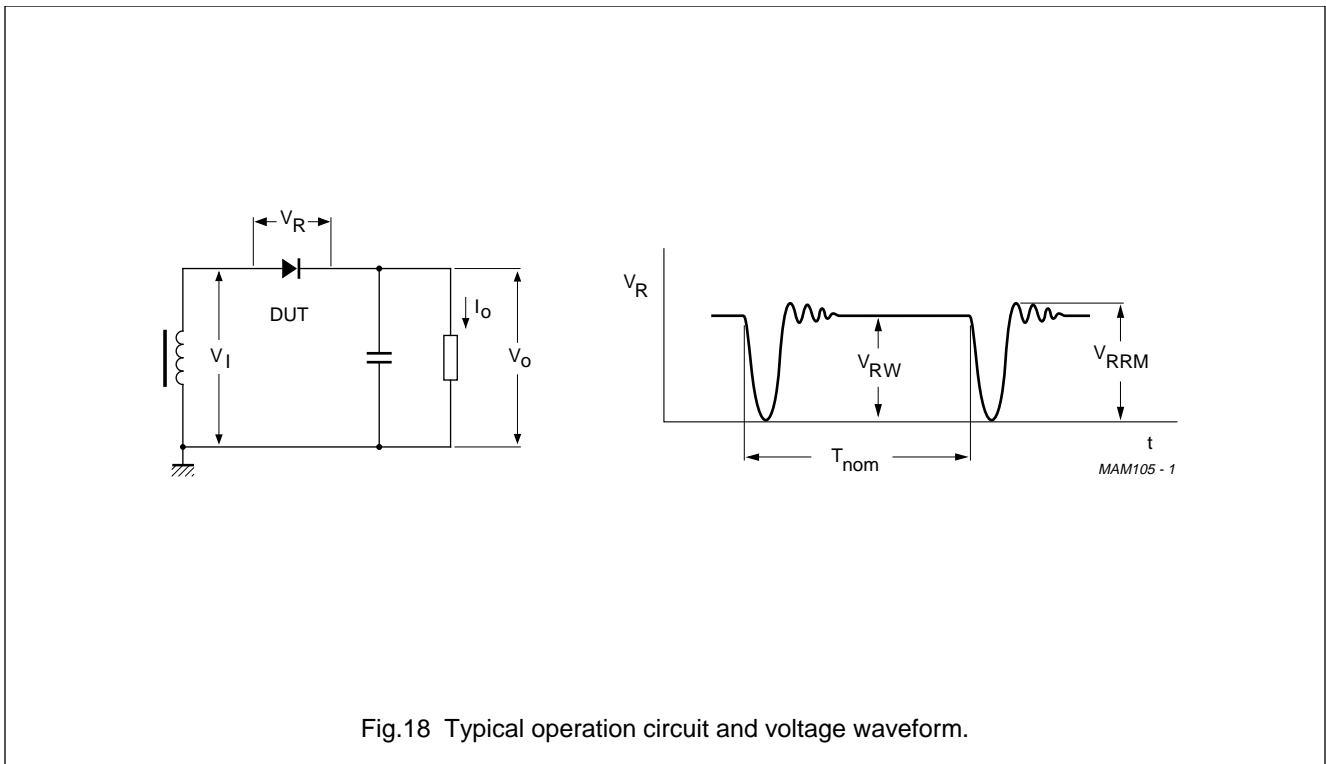

Fast high-voltage soft-recovery
controlled avalanche rectifiers

BY8000 series

PACKAGE OUTLINE

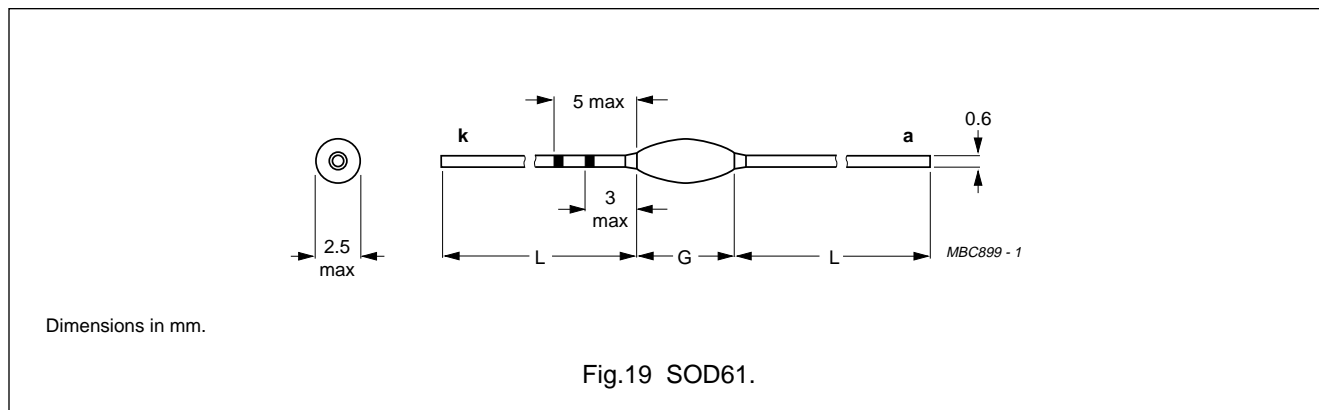

SOD61 package specification

TYPE NUMBER	PACKAGE CODE	L _{min} (mm)	G _{max} (mm)
BY8004	SOD61AC	30.4	8.3
BY8006	SOD61AD	30.2	8.7
BY8008	SOD61AE	30.0	9.1
BY8010	SOD61AF	29.8	9.5
BY8012	SOD61AH	29.3	10.5
BY8014	SOD61AI	28.8	11.5
BY8016	SOD61AJ	28.3	12.5

DEFINITIONS

Data Sheet Status	
Objective specification	This data sheet contains target or goal specifications for product development.
Preliminary specification	This data sheet contains preliminary data; supplementary data may be published later.
Product specification	This data sheet contains final product specifications.
Limiting values	
Limiting values given are in accordance with the Absolute Maximum Rating System (IEC 134). Stress above one or more of the limiting values may cause permanent damage to the device. These are stress ratings only and operation of the device at these or at any other conditions above those given in the Characteristics sections of the specification is not implied. Exposure to limiting values for extended periods may affect device reliability.	
Application information	
Where application information is given, it is advisory and does not form part of the specification.	

LIFE SUPPORT APPLICATIONS

These products are not designed for use in life support appliances, devices, or systems where malfunction of these products can reasonably be expected to result in personal injury. Philips customers using or selling these products for use in such applications do so at their own risk and agree to fully indemnify Philips for any damages resulting from such improper use or sale.