

**Silicon Diffused Power Transistor**

**BUX86P  
BUX87P**

**GENERAL DESCRIPTION**

High voltage, high speed glass passivated npn power transistors in a SOT82 envelope intended for use in converters, inverters, switching regulators, motor control systems and switching applications.

**QUICK REFERENCE DATA**

| SYMBOL      | PARAMETER                             | CONDITIONS                       | TYP. |     |      | UNIT    |
|-------------|---------------------------------------|----------------------------------|------|-----|------|---------|
|             |                                       |                                  | BUX  | 86P | 87P  |         |
| $V_{CESM}$  | Collector-emitter voltage peak value  | $V_{BE} = 0 V$                   | -    | 800 | 1000 | V       |
| $V_{CEO}$   | Collector-emitter voltage (open base) |                                  | -    | 400 | 450  | V       |
| $V_{CESAT}$ | Collector-emitter saturation voltage  | $I_C = 0.2 A; I_B = 20 mA$       | -    | 1   |      | V       |
| $I_C$       | Collector current (DC)                |                                  | -    | 0.5 |      | A       |
| $I_{CM}$    | Collector current peak value          |                                  | -    | 1   |      | A       |
| $P_{tot}$   | Total power dissipation               | $T_{mb} \leq 25 ^\circ C$        | -    | 42  |      | W       |
| $t_f$       | Fall time                             | $I_C = 0.2 A; I_{B(on)} = 20 mA$ | 0.28 | -   |      | $\mu s$ |

**PINNING - SOT82**

| PIN | DESCRIPTION |
|-----|-------------|
| 1   | emitter     |
| 2   | collector   |
| 3   | base        |

**PIN CONFIGURATION**

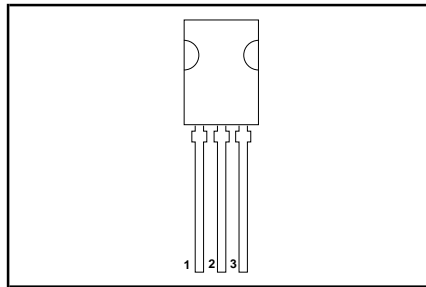

**SYMBOL**

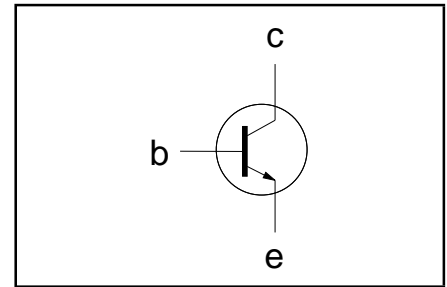

**LIMITING VALUES**

Limiting values in accordance with the Absolute Maximum Rating System (IEC 134)

| SYMBOL     | PARAMETER                                      | CONDITIONS                | MIN. |     |      | MAX. |     |      | UNIT       |
|------------|--|---------------------------|------|-----|------|------|-----|------|------------|
|            |  |                           | BUX  | 86P | 87P  | BUX  | 86P | 87P  |            |
| $V_{CESM}$ | Collector-emitter voltage peak value           | $V_{BE} = 0 V$            | -    | 800 | 1000 | -    | 800 | 1000 | V          |
| $V_{CEO}$  | Collector-emitter voltage (open base)          |                           | -    | 400 | 450  | -    | 400 | 450  | V          |
| $V_{EBO}$  | Emitter-base voltage (open collector)          | $T_{mb} \leq 25 ^\circ C$ | -    | 5   |      | -    | 5   |      | V          |
| $I_C$      | Collector current (DC)                         |                           | -    | 0.5 |      | -    | 0.5 |      | A          |
| $I_{CM}$   | Collector current (peak value) $t_p = 2 ms$    |                           | -    | 1   |      | -    | 1   |      | A          |
| $I_B$      | Base current (DC)                              |                           | -    | 0.2 |      | -    | 0.2 |      | A          |
| $I_{BM}$   | Base current (peak value)                      |                           | -    | 0.3 |      | -    | 0.3 |      | A          |
| $-I_{BM}$  | Reverse base current (peak value) <sup>1</sup> |                           | -    | 0.3 |      | -    | 0.3 |      | A          |
| $P_{tot}$  | Total power dissipation                        |                           | -    | 42  |      | -    | 42  |      | W          |
| $T_{stg}$  | Storage temperature                            | -                         | -40  | 150 |      | -    | 150 |      | $^\circ C$ |
| $T_j$      | Junction temperature                           | -                         | -    | 150 |      | -    | 150 |      | $^\circ C$ |

<sup>1</sup> Turn-off current.

## Silicon Diffused Power Transistor

BUX86P  
BUX87P

## THERMAL RESISTANCES

| SYMBOL         | PARAMETER                 | CONDITIONS  | TYP. | MAX. | UNIT |
|----------------|---------------------------|-------------|------|------|------|
| $R_{th\ j-mb}$ | Junction to mounting base |             | -    | 3    | K/W  |
| $R_{th\ j-a}$  | Junction to ambient       | in free air | 100  | -    | K/W  |

## STATIC CHARACTERISTICS

 $T_{mb} = 25\text{ }^{\circ}\text{C}$  unless otherwise specified

| SYMBOL        | PARAMETER                             | CONDITIONS   | MIN.                           | TYP. | MAX. | UNIT          |
|---------------|---------------------------------------|--|--------------------------------|------|------|---------------|
| $I_{CES}$     |                                       | $V_{BE} = 0\text{ V}; V_{CE} = V_{CESMmax}$                                    | -                              | -    | 100  | $\mu\text{A}$ |
| $I_{CES}$     |                                       | $V_{BE} = 0\text{ V}; V_{CE} = V_{CESMmax}$                                    | -                              | -    | 1.0  | mA            |
| $I_{EBO}$     | Emitter cut-off current               | $T_j = 125\text{ }^{\circ}\text{C}$<br>$V_{EB} = 5\text{ V}; I_C = 0\text{ A}$ | -                              | -    | 1    | mA            |
| $V_{CEsat}$   | Collector-emitter saturation voltages | $I_C = 0.1\text{ A}; I_B = 10\text{ mA}$                                       | -                              | -    | 0.8  | V             |
| $V_{CEsat}$   |                                       | $I_C = 0.2\text{ A}; I_B = 20\text{ mA}$                                       | -                              | -    | 1    | V             |
| $V_{BEsat}$   | Base-emitter saturation voltage       | $I_C = 0.2\text{ A}; I_B = 20\text{ mA}$                                       | -                              | -    | 1    | V             |
| $h_{FE}$      | DC current gain                       | $I_C = 50\text{ mA}; V_{CE} = 5\text{ V}$                                      | 26                             | 50   | 125  |               |
| $V_{CEOsust}$ | Collector-emitter sustaining voltage  | $I_C = 100\text{ mA};$   | 400                            | -    | -    | V             |
|               |                                       | $I_{Boff} = 0; L = 25\text{ mH}$   | <b>BUX86P</b><br><b>BUX87P</b> | 450  | -    | -             |

## DYNAMIC CHARACTERISTICS

 $T_{mb} = 25\text{ }^{\circ}\text{C}$  unless otherwise specified

| SYMBOL   | PARAMETER                         | CONDITIONS   | TYP. | MAX. | UNIT          |
|----------|-----------------------------------|--|------|------|---------------|
|          | Switching times (resistive load). | $I_C = 0.2\text{ A}; I_{Bon} = 20\text{ mA}; -I_{Boff} = 40\text{ mA};$<br>$V_{CC} = 250\text{ V}$ |      |      |               |
| $t_{on}$ | Turn-on time                      |  | 0.25 | 0.5  | $\mu\text{s}$ |
| $t_s$    | Turn-off storage time             |  | 2    | 3.5  | $\mu\text{s}$ |
| $t_f$    | Turn-off fall time                |  | 0.28 | -    | $\mu\text{s}$ |
| $t_f$    | Turn-off fall time                | $T_{mb} = 95\text{ }^{\circ}\text{C}$  | -    | 1.3  | $\mu\text{s}$ |

Silicon Diffused Power Transistor

BUX86P  
BUX87P

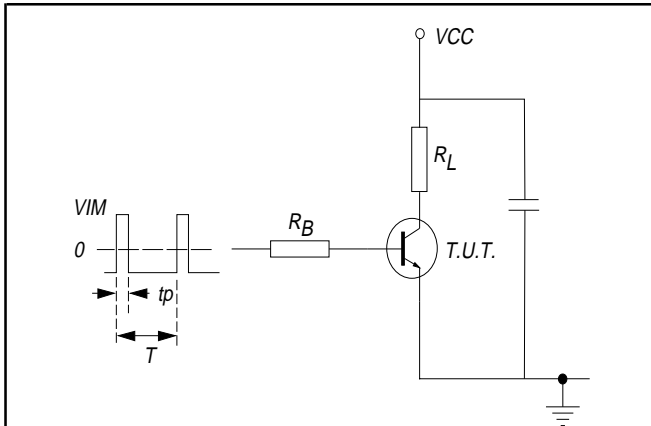

Fig. 1. Test circuit resistive load.  $V_{IM} = -6$  to  $+8$  V  
 $V_{CC} = 250$  V;  $t_p = 20 \mu s$ ;  $\delta = t_p / T = 0.01$ .  
 $R_B$  and  $R_L$  calculated from  $I_{Con}$  and  $I_{Bon}$  requirements.

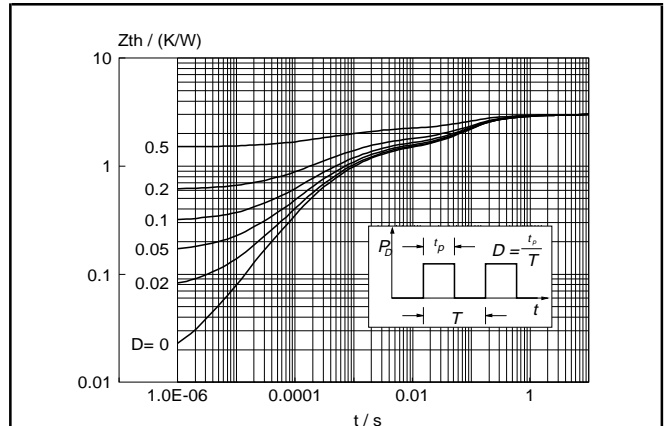

Fig. 4. Transient thermal impedance.  
 $Z_{thj-mb} = f(t)$ ; parameter  $D = t_p / T$

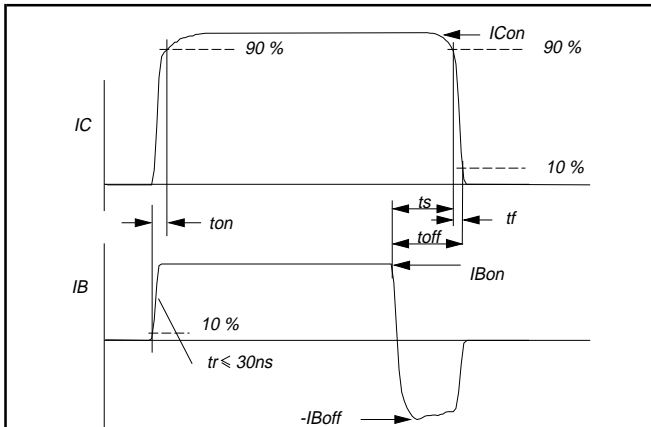

Fig. 2. Switching times waveforms with resistive load.

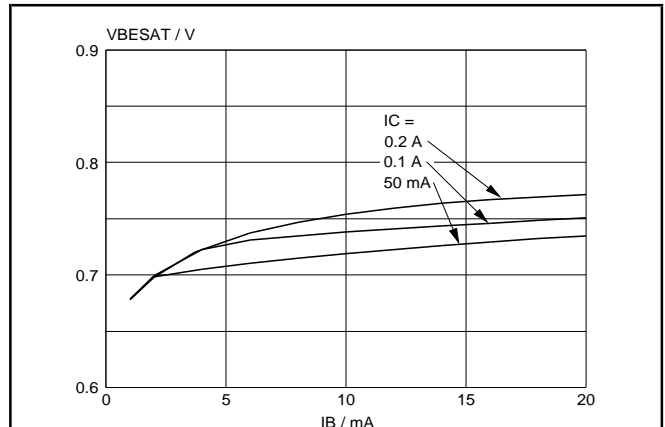

Fig. 5. Typical base-emitter saturation voltage.  
 $V_{BEsat} = f(I_B)$ ; parameter  $I_C$

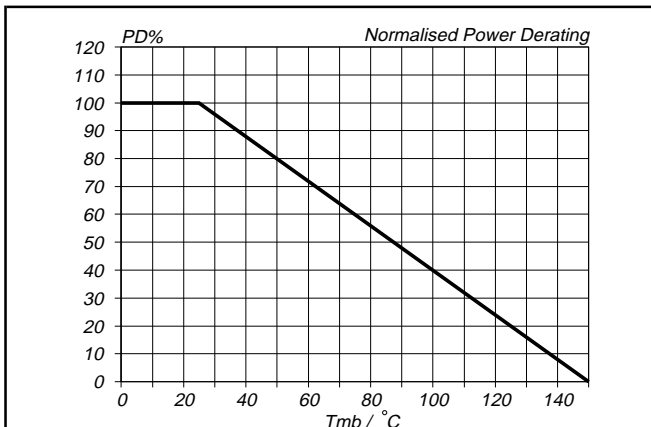

Fig. 3. Normalised power dissipation.  
 $PD\% = 100 \cdot PD / PD_{25^\circ C} = f(T_{mb})$

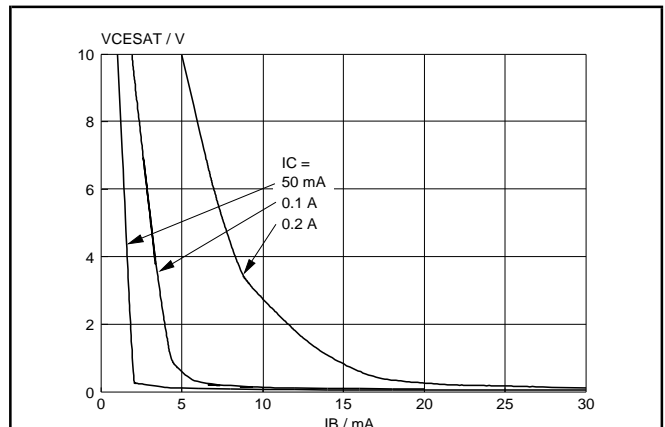
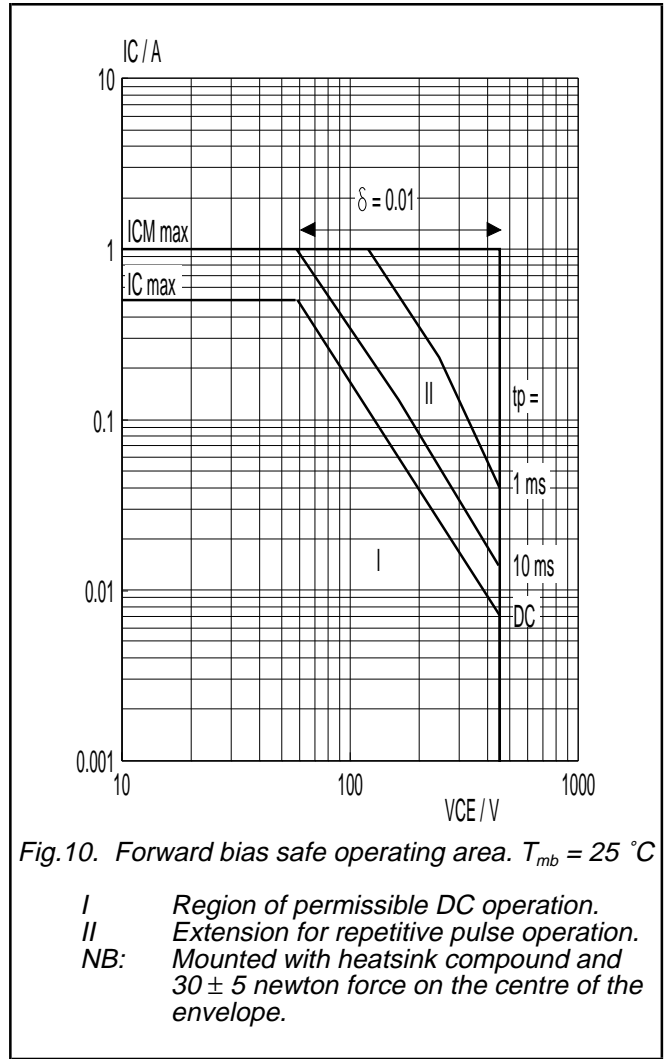
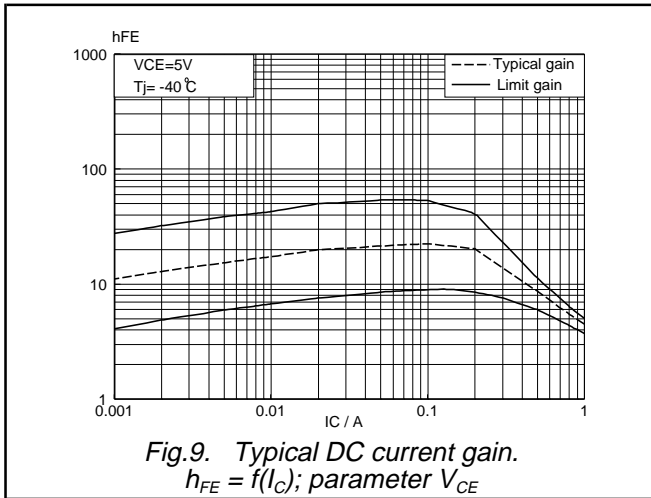
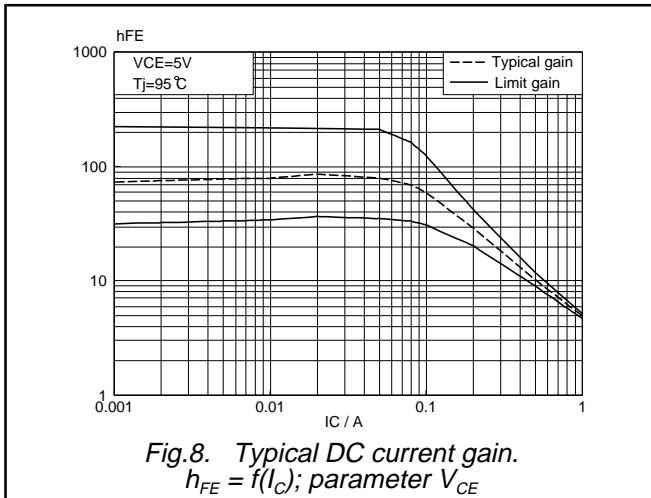
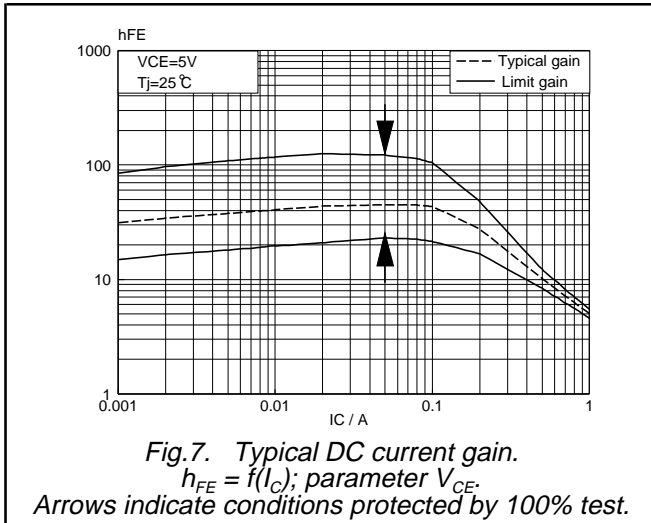

Fig. 6. Typical collector-emitter saturation voltage.  
 $V_{CEsat} = f(I_B)$ ; parameter  $I_C$

Silicon Diffused Power Transistor

BUX86P  
BUX87P



Silicon Diffused Power Transistor

BUX86P  
BUX87P

**MECHANICAL DATA**

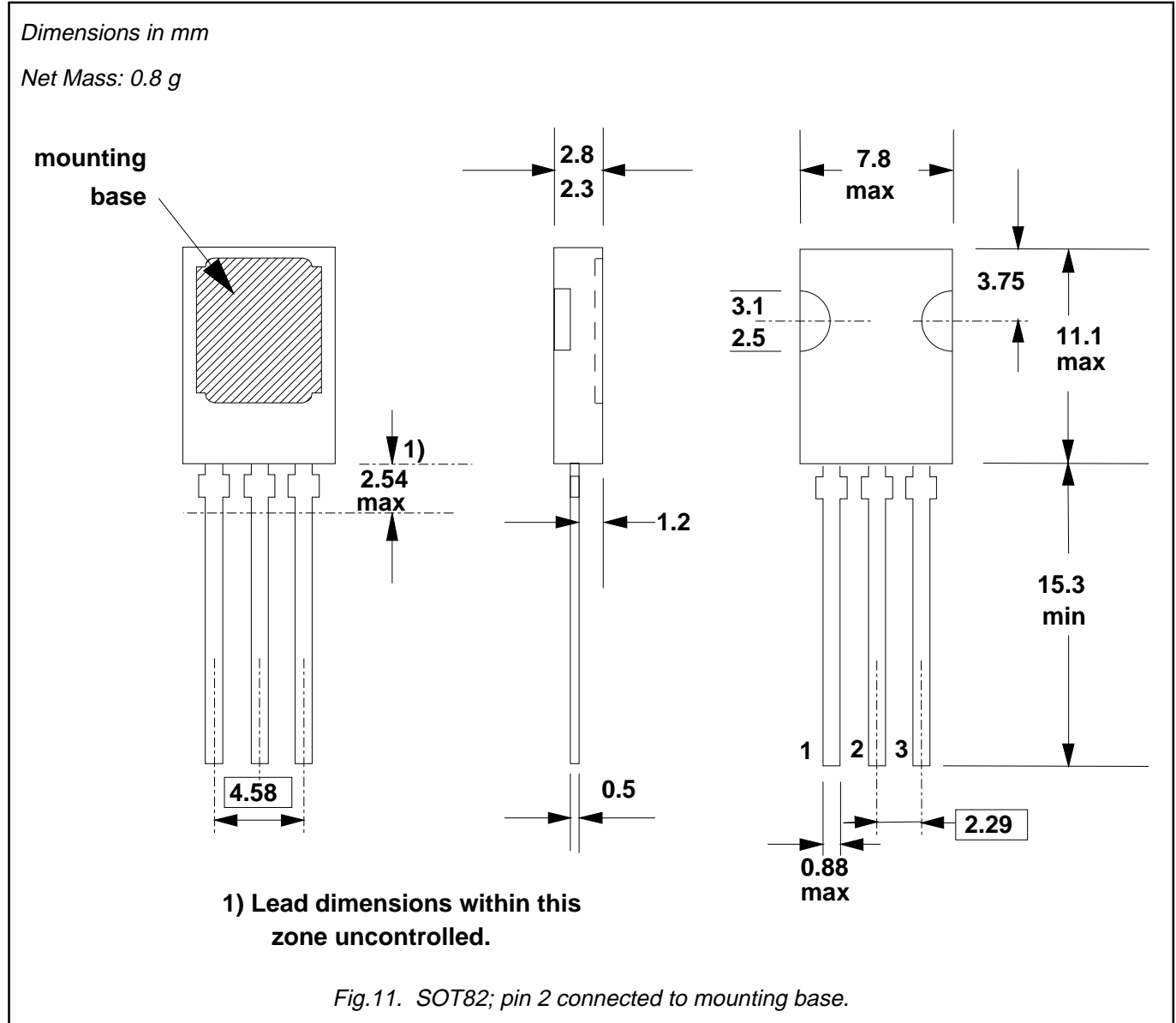

**Notes**

1. Refer to mounting instructions for SOT82 envelopes.
2. Epoxy meets UL94 V0 at 1/8".

## Silicon Diffused Power Transistor

BUX86P  
BUX87P**DEFINITIONS**

|  |   |
|--|---|
| <b>Data sheet status</b>   |   |
| Objective specification  | This data sheet contains target or goal specifications for product development.       |
| Preliminary specification  | This data sheet contains preliminary data; supplementary data may be published later. |
| Product specification  | This data sheet contains final product specifications.                                |
| <b>Limiting values</b>   |   |
| Limiting values are given in accordance with the Absolute Maximum Rating System (IEC 134). Stress above one or more of the limiting values may cause permanent damage to the device. These are stress ratings only and operation of the device at these or at any other conditions above those given in the Characteristics sections of this specification is not implied. Exposure to limiting values for extended periods may affect device reliability. |   |
| <b>Application information</b>   |   |
| Where application information is given, it is advisory and does not form part of the specification.  |   |
| © Philips Electronics N.V. 1995  |   |
| All rights are reserved. Reproduction in whole or in part is prohibited without the prior written consent of the copyright owner.  |   |
| The information presented in this document does not form part of any quotation or contract, it is believed to be accurate and reliable and may be changed without notice. No liability will be accepted by the publisher for any consequence of its use. Publication thereof does not convey nor imply any license under patent or other industrial or intellectual property rights.   |   |

**LIFE SUPPORT APPLICATIONS**

These products are not designed for use in life support appliances, devices or systems where malfunction of these products can be reasonably expected to result in personal injury. Philips customers using or selling these products for use in such applications do so at their own risk and agree to fully indemnify Philips for any damages resulting from such improper use or sale.