

DATA SHEET

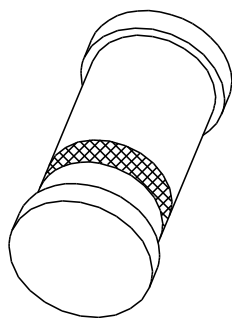

PMLL4148; PMLL4446; PMLL4448 High-speed diodes

Product specification
Supersedes data of November 1993
File under Discrete Semiconductors, SC01

1996 Apr 23

High-speed diodes

PMLL4148; PMLL4446; PMLL4448

FEATURES

- Small hermetically sealed glass SMD package
- High switching speed: max. 4 ns
- Continuous reverse voltage: max. 75 V
- Repetitive peak reverse voltage: max. 75 V
- Repetitive peak forward current: max. 450 mA
- Forward voltage: max. 1 V.

APPLICATIONS

- High-speed switching
- Fast logic applications.

DESCRIPTION

The PMLL4148, PMLL4446, PMLL4448 are high-speed switching diodes fabricated in planar technology, and encapsulated in small hermetically sealed glass SOD80C SMD packages.

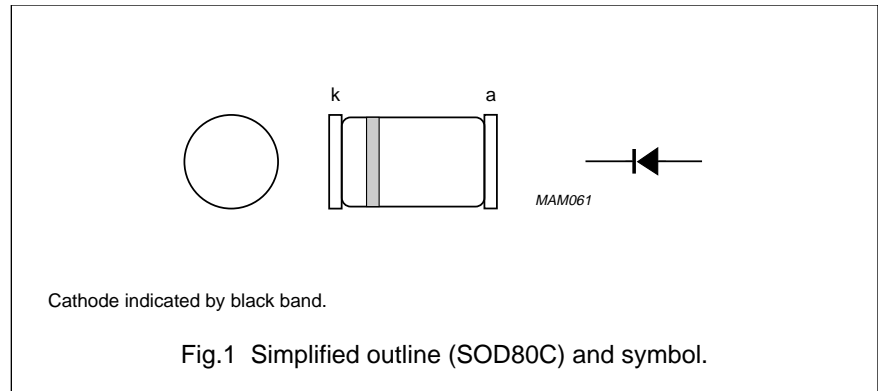

LIMITING VALUES

In accordance with the Absolute Maximum Rating System (IEC 134).

SYMBOL	PARAMETER	CONDITIONS	MIN.	MAX.	UNIT
V_{RRM}	repetitive peak reverse voltage		–	75	V
V_R	continuous reverse voltage		–	75	V
I_F	continuous forward current	see Fig.2; note 1	–	200	mA
I_{FRM}	repetitive peak forward current		–	450	mA
I_{FSM}	non-repetitive peak forward current	square wave; $T_j = 25\text{ °C}$ prior to surge; see Fig.4			
		$t = 1\ \mu\text{s}$	–	4	A
		$t = 1\ \text{ms}$	–	1	A
		$t = 1\ \text{s}$	–	0.5	A
P_{tot}	total power dissipation	$T_{amb} = 25\text{ °C}$; note 1	–	500	mW
T_{stg}	storage temperature		–65	+200	°C
T_j	junction temperature		–	200	°C

Note

1. Device mounted on an FR4 printed-circuit board.

High-speed diodes

PMLL4148; PMLL4446; PMLL4448

ELECTRICAL CHARACTERISTICS

$T_j = 25\text{ °C}$; unless otherwise specified.

SYMBOL	PARAMETER	CONDITIONS	MIN.	MAX.	UNIT
V_F	forward voltage	see Fig.3			
	PMLL4148	$I_F = 10\text{ mA}$	–	1.0	V
	PMLL4446	$I_F = 20\text{ mA}$	–	1.0	V
	PMLL4448	$I_F = 5\text{ mA}$	620	720	mV
		$I_F = 100\text{ mA}$	–	1.0	V
I_R	reverse current	$V_R = 20\text{ V}$; see Fig.5		25	nA
		$V_R = 20\text{ V}$; $T_j = 150\text{ °C}$; see Fig.5	–	50	μA
I_R	reverse current; PMLL4448	$V_R = 20\text{ V}$; $T_j = 100\text{ °C}$; see Fig.5	–	3	μA
C_d	diode capacitance	$f = 1\text{ MHz}$; $V_R = 0$; see Fig.6		4	pF
t_{rr}	reverse recovery time	when switched from $I_F = 10\text{ mA}$ to $I_R = 60\text{ mA}$; $R_L = 100\ \Omega$; measured at $I_R = 1\text{ mA}$; see Fig.7		4	ns
V_{fr}	forward recovery voltage	when switched from $I_F = 50\text{ mA}$; $t_r = 20\text{ ns}$; see Fig.8	–	2.5	V

THERMAL CHARACTERISTICS

SYMBOL	PARAMETER	CONDITIONS	VALUE	UNIT
$R_{th\ j\text{-tp}}$	thermal resistance from junction to tie-point		300	K/W
$R_{th\ j\text{-a}}$	thermal resistance from junction to ambient	note 1	350	K/W

Note

1. Device mounted on an FR4 printed-circuit board.

High-speed diodes

PMLL4148; PMLL4446; PMLL4448

GRAPHICAL DATA

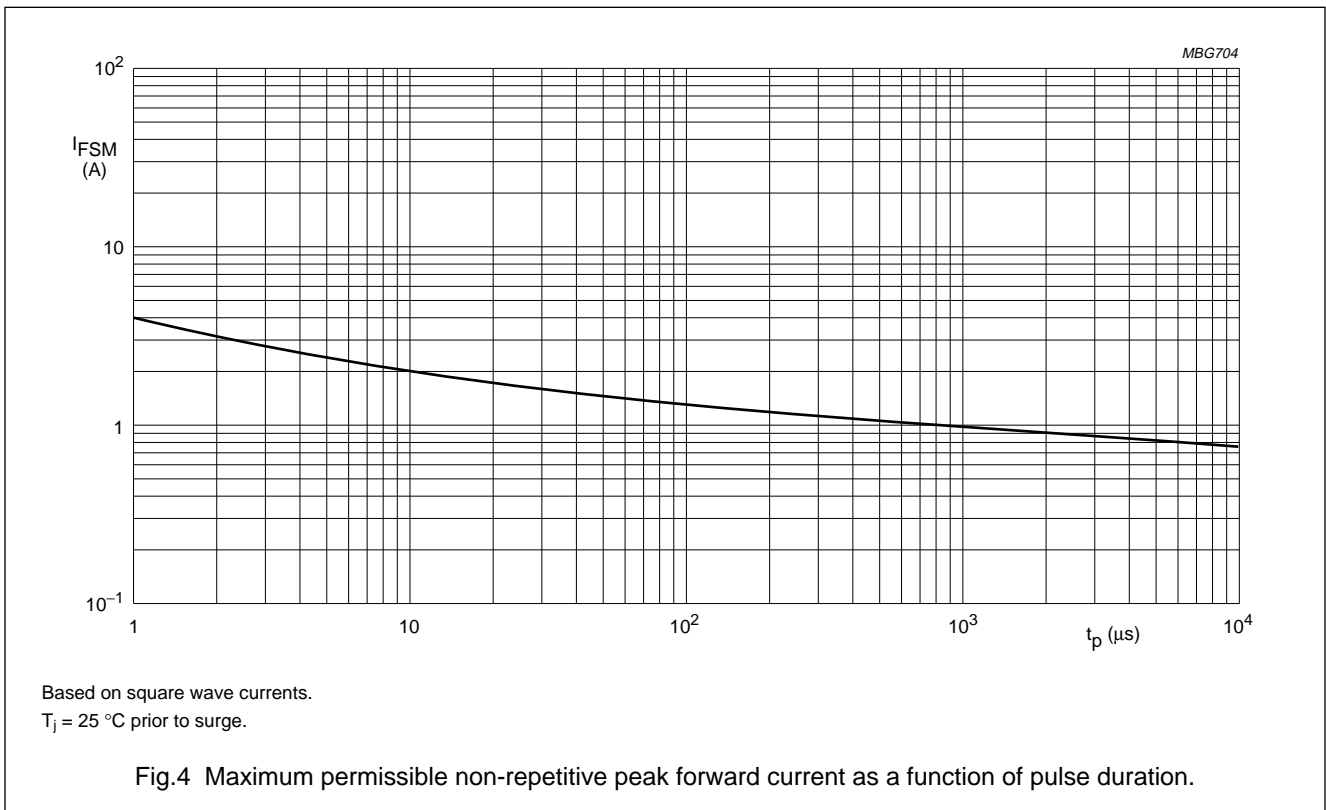
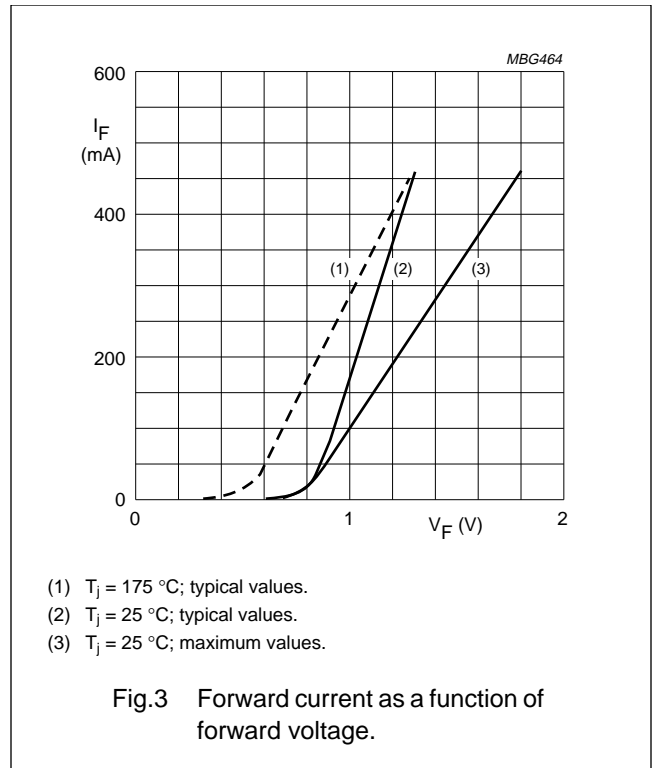
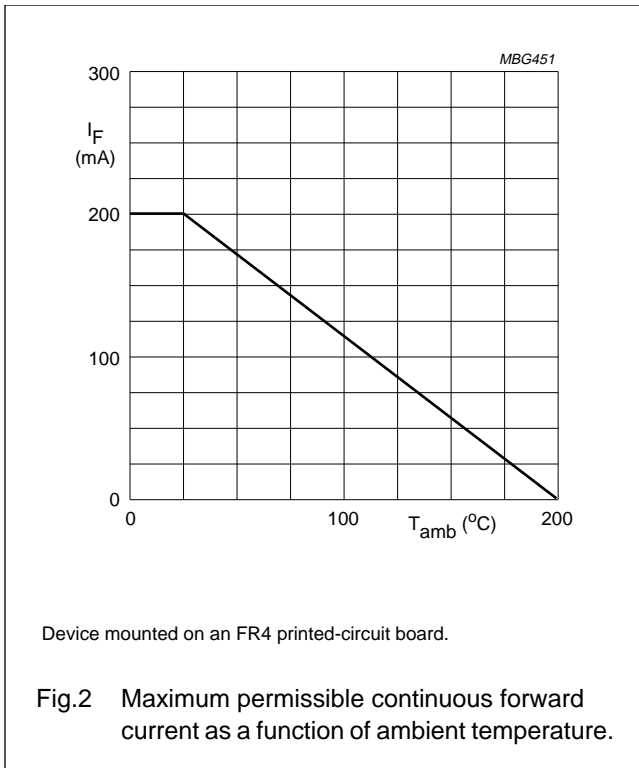

High-speed diodes

PMLL4148; PMLL4446; PMLL4448

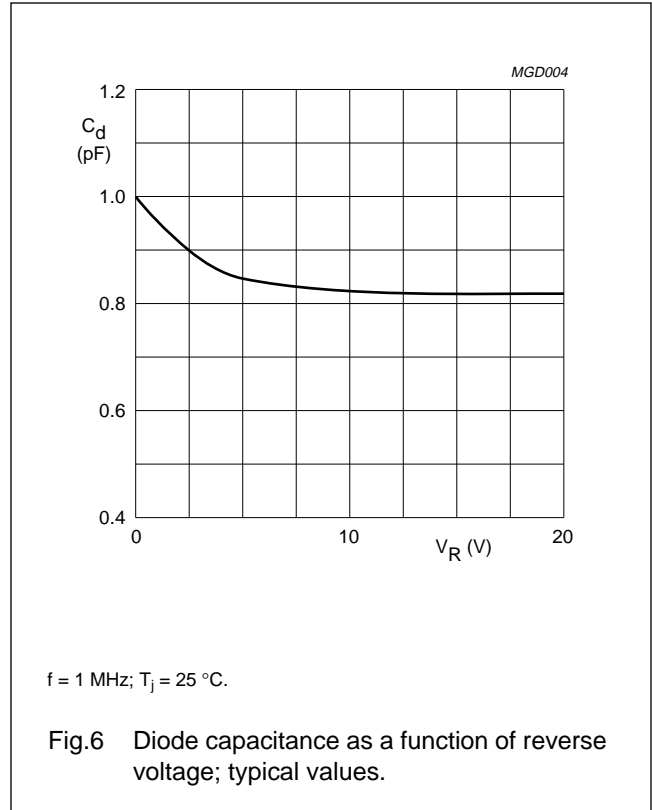
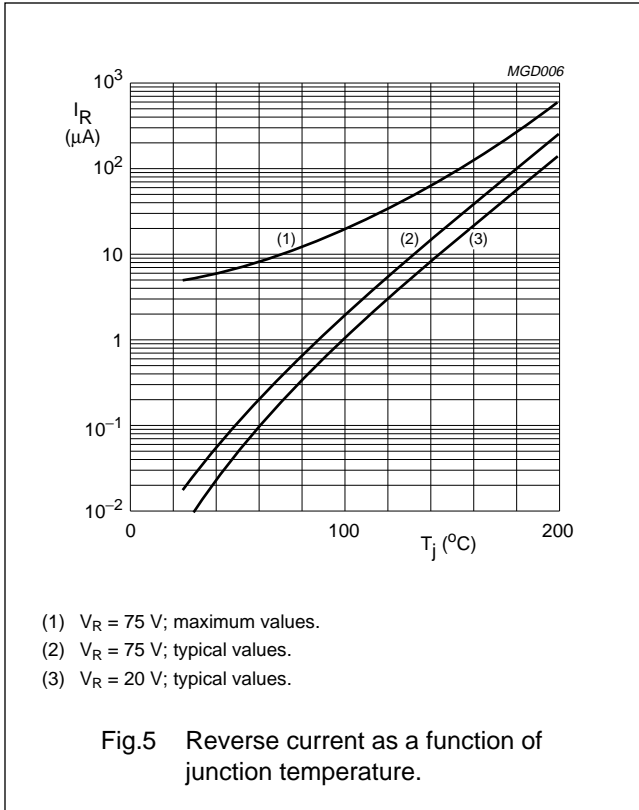

High-speed diodes

PMLL4148; PMLL4446; PMLL4448

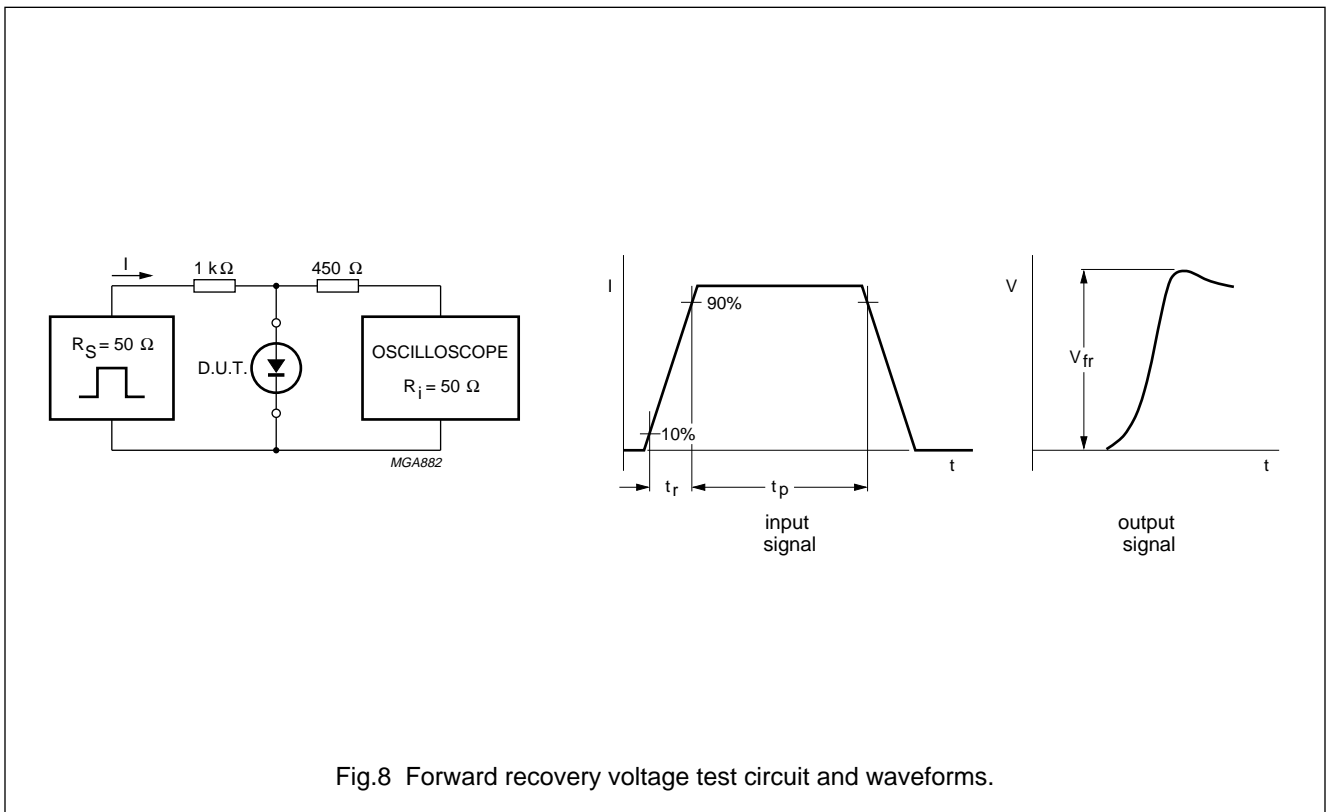
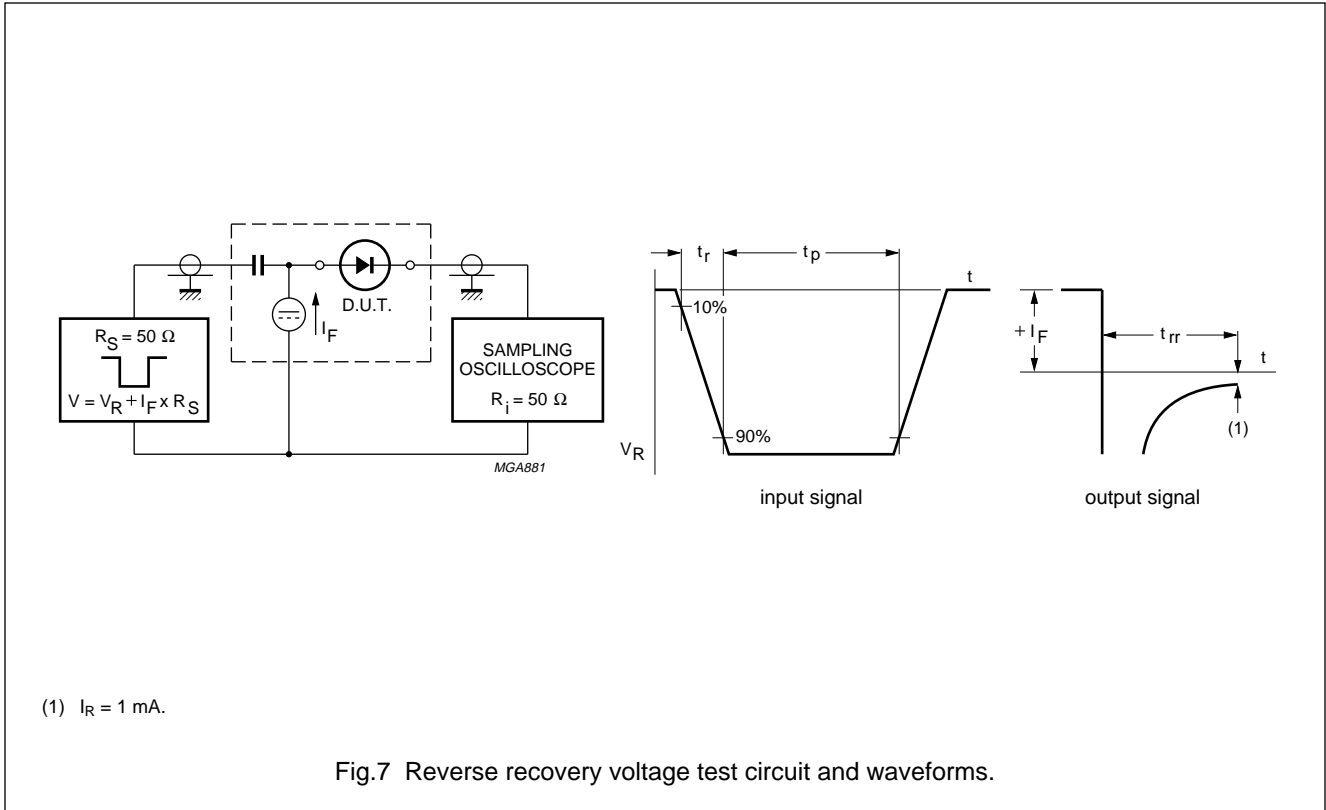

High-speed diodes

PMLL4148; PMLL4446; PMLL4448

PACKAGE OUTLINE

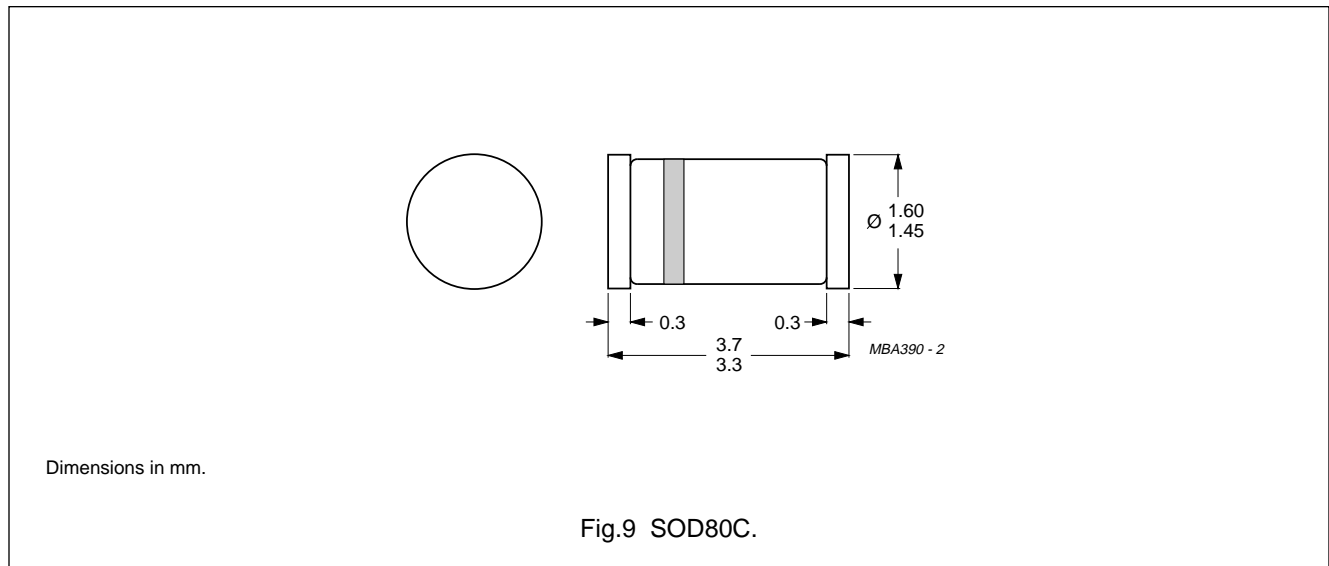

DEFINITIONS

Data Sheet Status	
Objective specification	This data sheet contains target or goal specifications for product development.
Preliminary specification	This data sheet contains preliminary data; supplementary data may be published later.
Product specification	This data sheet contains final product specifications.
Limiting values	
Limiting values given are in accordance with the Absolute Maximum Rating System (IEC 134). Stress above one or more of the limiting values may cause permanent damage to the device. These are stress ratings only and operation of the device at these or at any other conditions above those given in the Characteristics sections of the specification is not implied. Exposure to limiting values for extended periods may affect device reliability.	
Application information	
Where application information is given, it is advisory and does not form part of the specification.	

LIFE SUPPORT APPLICATIONS

These products are not designed for use in life support appliances, devices, or systems where malfunction of these products can reasonably be expected to result in personal injury. Philips customers using or selling these products for use in such applications do so at their own risk and agree to fully indemnify Philips for any damages resulting from such improper use or sale.