

DATA SHEET

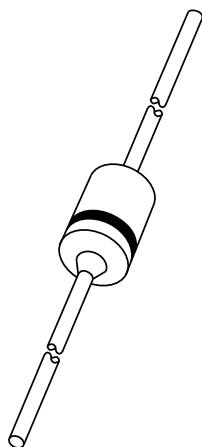

BYD43 series **Fast soft-recovery rectifiers**

Product specification
Supersedes data of February 1995
File under Discrete Semiconductors, SC01

1996 Jun 05

Fast soft-recovery rectifiers

BYD43 series

FEATURES

- Glass passivated
- High maximum operating temperature
- Low leakage current
- Excellent stability
- Available in ammo-pack.

DESCRIPTION

Cavity free cylindrical glass package through Implotec™⁽¹⁾ technology. This package is hermetically sealed

and fatigue free as coefficients of expansion of all used parts are matched.

(1) Implotec is a trademark of Philips.

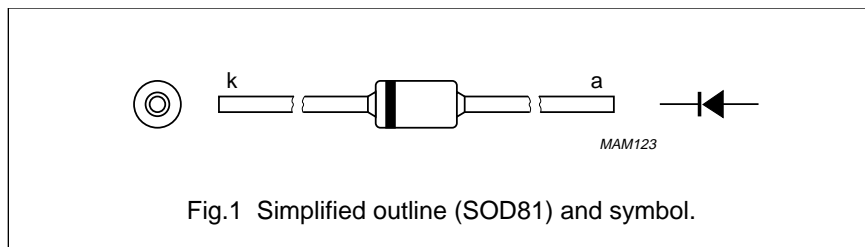

LIMITING VALUES

In accordance with the Absolute Maximum Rating System (IEC 134).

SYMBOL	PARAMETER	CONDITIONS	MIN.	MAX.	UNIT
V_{RSM}	non-repetitive peak reverse voltage				
	BYD43U		–	1300	V
	BYD43V		–	1500	V
	BYD43-16		–	1700	V
	BYD43-18		–	1900	V
BYD43-20		–	2100	V	
V_{RRM}	repetitive peak reverse voltage				
	BYD43U		–	1200	V
	BYD43V		–	1400	V
	BYD43-16		–	1600	V
	BYD43-18		–	1800	V
BYD43-20		–	2000	V	
$I_{F(AV)}$	average forward current	$T_{tp} = 55\text{ °C}$; lead length = 10 mm; see Figs 2 and 3;			
	BYD43U and V	averaged over any 20 ms period; see also Figs 10 and 11	–	1.20	A
$I_{F(AV)}$	average forward current	$T_{amb} = 65\text{ °C}$; PCB mounting (see Fig.20); see Figs 4 and 5;			
	BYD43-16 to 20	averaged over any 20 ms period; see also Figs 10 and 11	–	0.65	A
I_{FRM}	repetitive peak forward current	$T_{tp} = 55\text{ °C}$; see Figs 6 and 7			
	BYD43U and V		–	11	A
I_{FRM}	repetitive peak forward current	$T_{amb} = 65\text{ °C}$; see Figs 8 and 9			
	BYD43-16 to 20		–	6	A
I_{FRM}	repetitive peak forward current				
	BYD43U and V		–	6.0	A
I_{FRM}	repetitive peak forward current				
	BYD43-16 to 20		–	3.2	A

Fast soft-recovery rectifiers

BYD43 series

SYMBOL	PARAMETER	CONDITIONS	MIN.	MAX.	UNIT
I_{FSM}	non-repetitive peak forward current	$t = 10$ ms half sinewave; $T_j = T_{j\ max}$ prior to surge; $V_R = V_{RRM\ max}$	–	6	A
	BYD43U and V		–	6	A
T_{stg}	storage temperature		–65	+175	°C
T_j	junction temperature	see Figs 12 and 13	–65	+175	°C

ELECTRICAL CHARACTERISTICS

$T_j = 25$ °C unless otherwise specified.

SYMBOL	PARAMETER	CONDITIONS	MIN.	TYP.	MAX.	UNIT
V_F	forward voltage	$I_F = 1$ A; $T_j = T_{j\ max}$; see Figs 14 and 15	–	–	1.20	V
	BYD43U and V		–	–	2.05	V
V_F	forward voltage	$I_F = 1$ A; see Figs 14 and 15	–	–	1.5	V
	BYD43-16 to 20		–	–	2.4	V
I_R	reverse current	$V_R = V_{RRM\ max}$; see Figs 16 and 17	–	–	1	µA
	BYD43-16 to 20		–	–	5	µA
I_R	reverse current	$V_R = V_{RRM\ max}$ $T_j = 165$ °C; see Fig 16	–	–	100	µA
	BYD43-16 to 20		$T_j = 125$ °C; see Fig 17	–	–	50
t_{rr}	reverse recovery time	when switched from $I_F = 0.5$ A to $I_R = 1$ A; measured at $I_R = 0.25$ A; see Fig 22	–	–	250	ns
	BYD43-16 to 20		–	–	300	ns
C_d	diode capacitance	$f = 1$ MHz; $V_R = 0$ V; see Figs 18 and 19	–	20	–	pF
	BYD43-16 to 20		–	15	–	pF
$\left \frac{dI_R}{dt} \right $	maximum slope of reverse recovery current	when switched from $I_F = 1$ A to $V_R \geq 30$ V and $dI_F/dt = -1$ A/µs; see Fig.21	–	–	5	A/µs
	BYD43-16 to 20		–	–	5	A/µs

THERMAL CHARACTERISTICS

SYMBOL	PARAMETER	CONDITIONS	VALUE	UNIT
$R_{th\ j-tp}$	thermal resistance from junction to tie-point	lead length = 10 mm	60	K/W
$R_{th\ j-a}$	thermal resistance from junction to ambient	note 1	120	K/W

Note

- Device mounted on an epoxy-glass printed-circuit board, 1.5 mm thick; thickness of Cu-layer ≥ 40 µm, see Fig.20. For more information please refer to the 'General Part of Handbook SC01'.

Fast soft-recovery rectifiers

BYD43 series

GRAPHICAL DATA

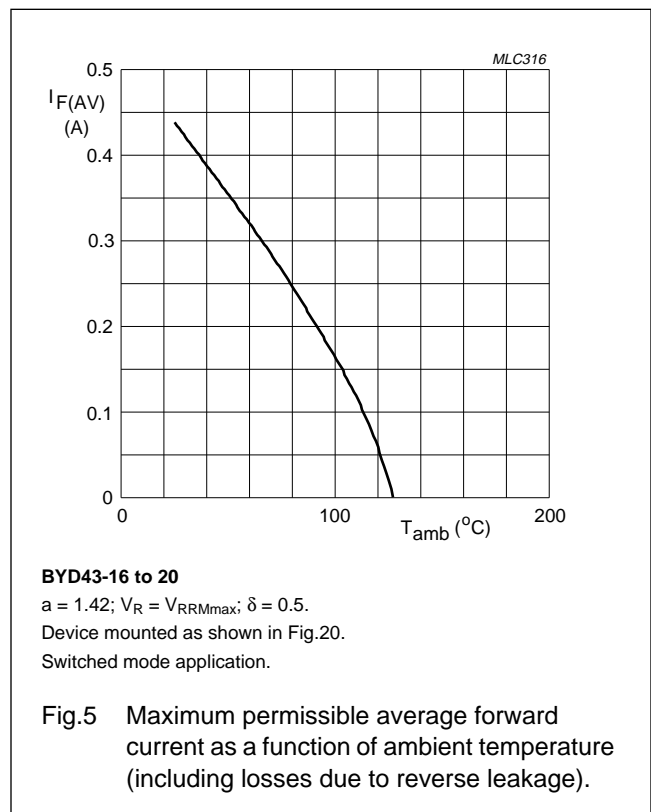
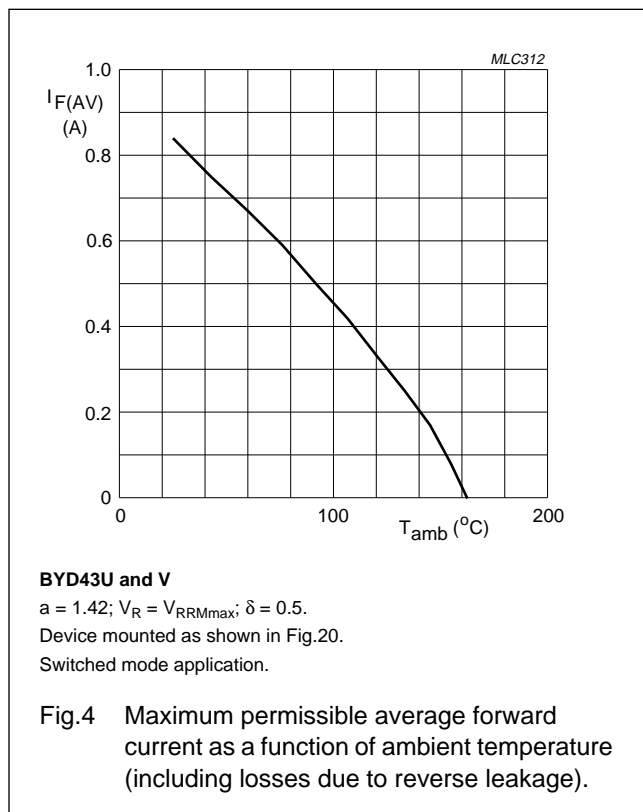
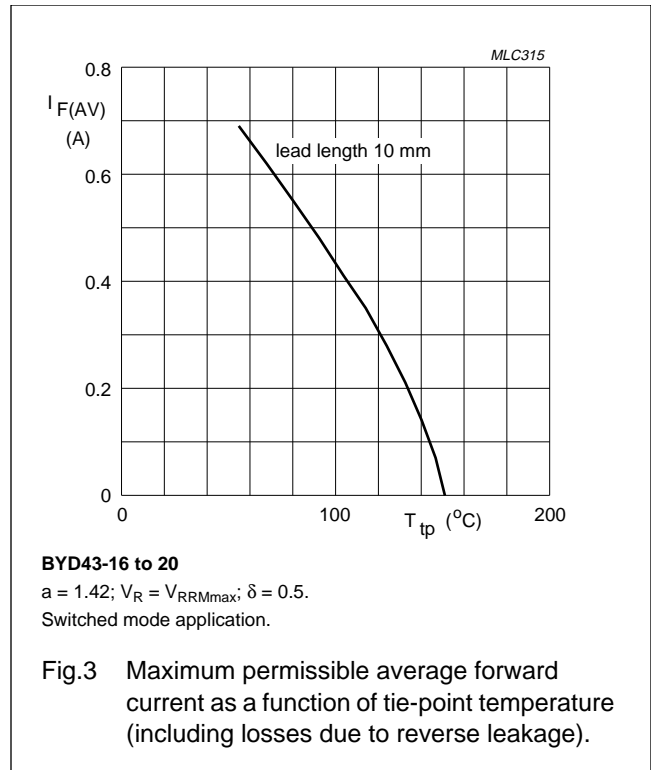
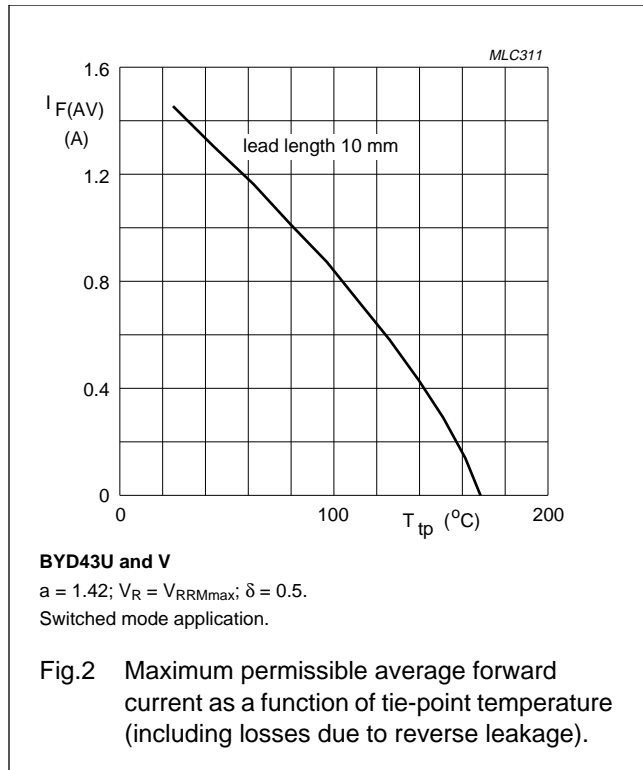

Fast soft-recovery rectifiers

BYD43 series

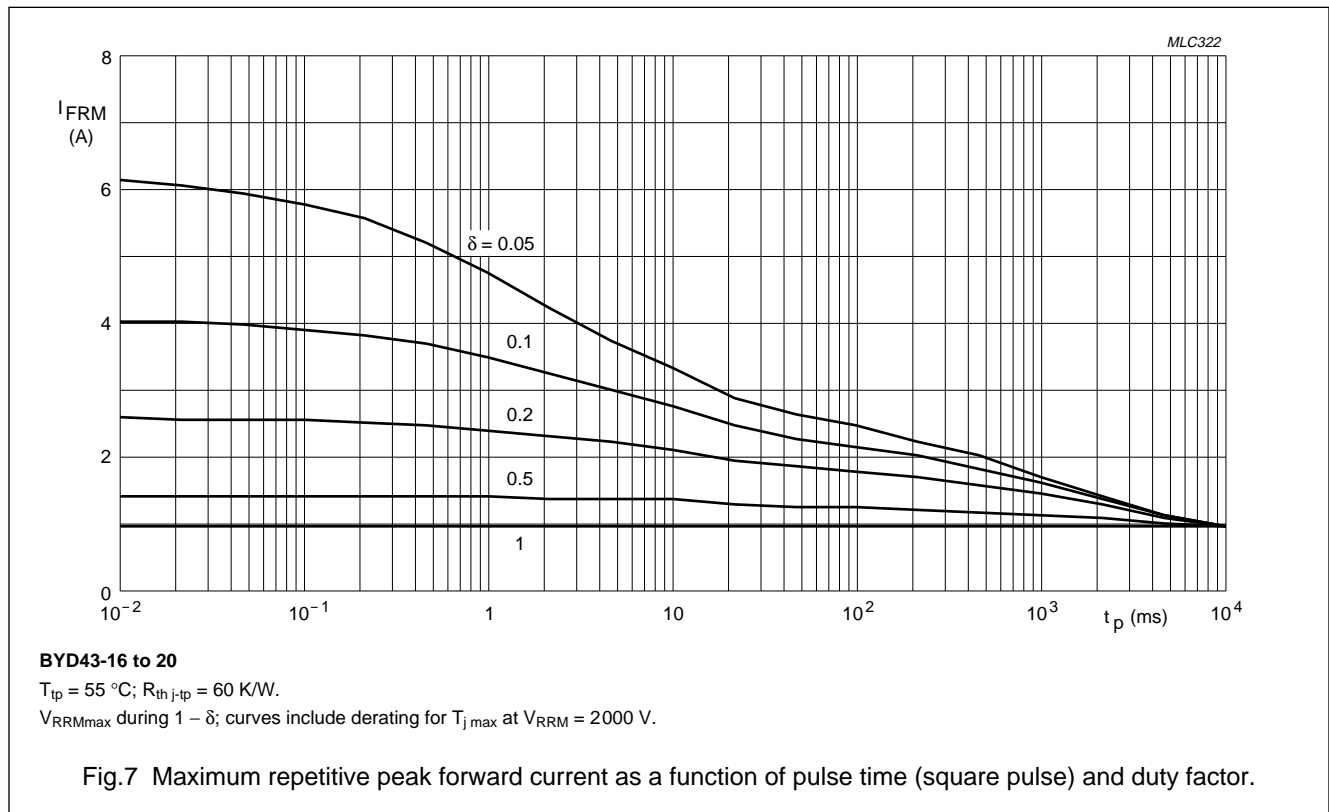
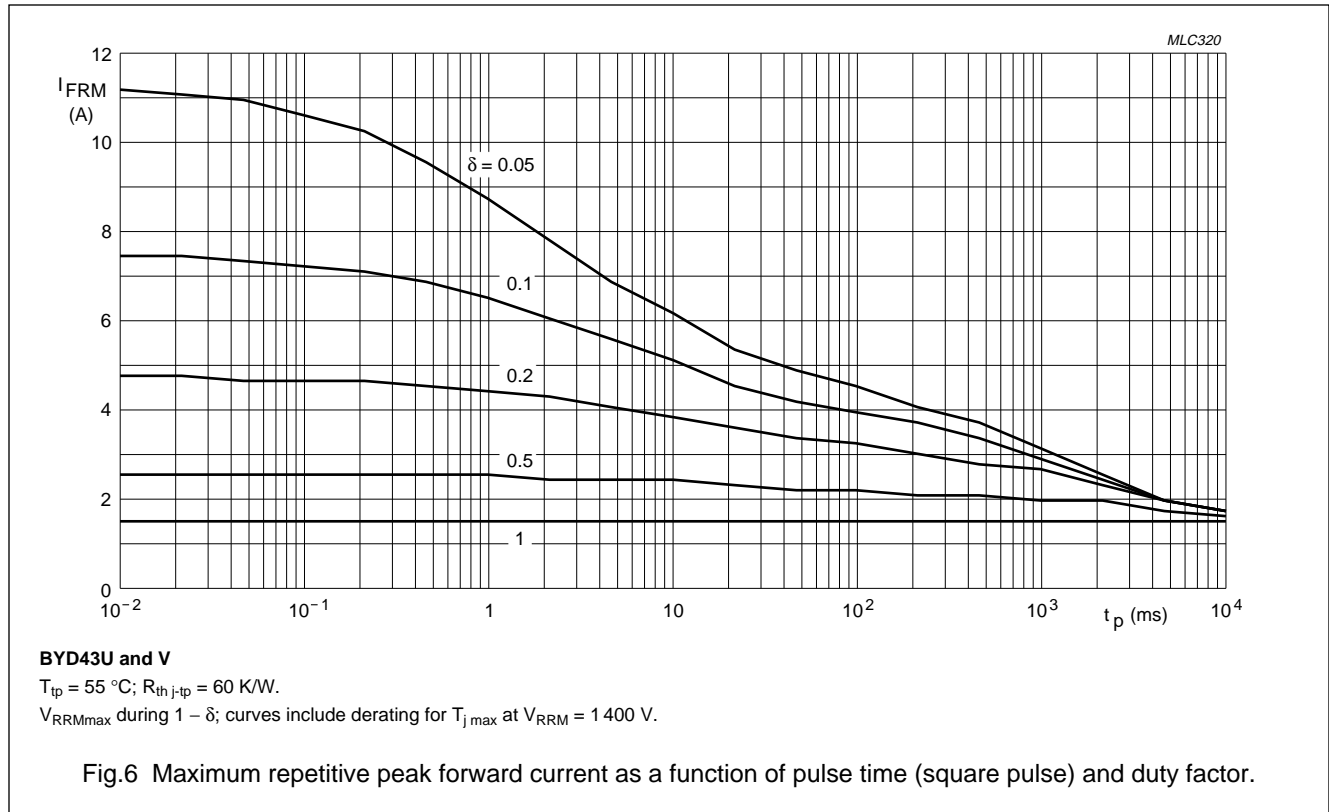

Fast soft-recovery rectifiers

BYD43 series

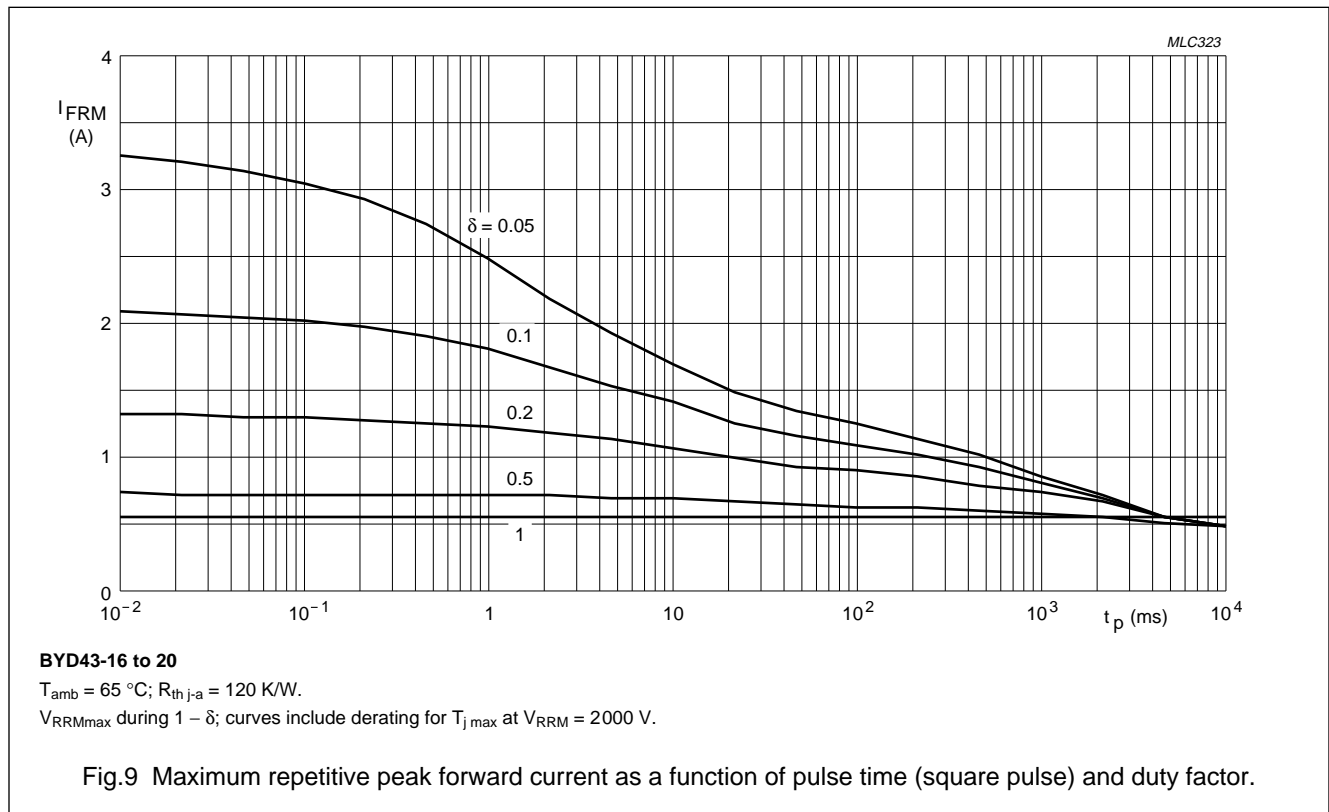
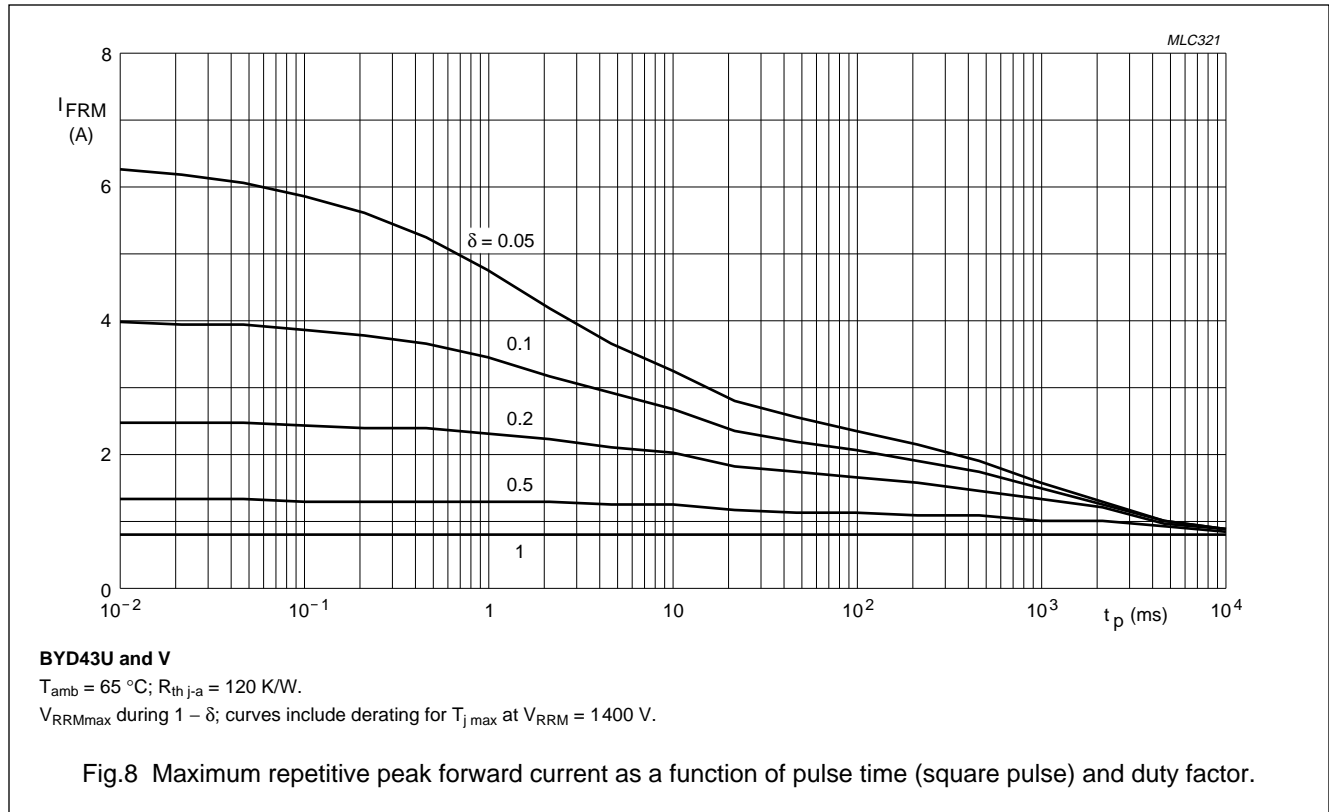

Fast soft-recovery rectifiers

BYD43 series

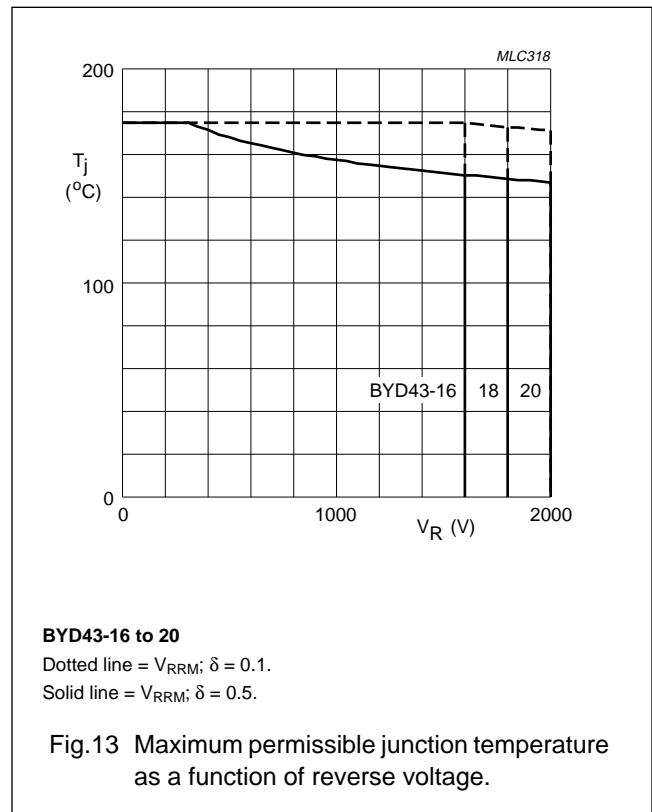
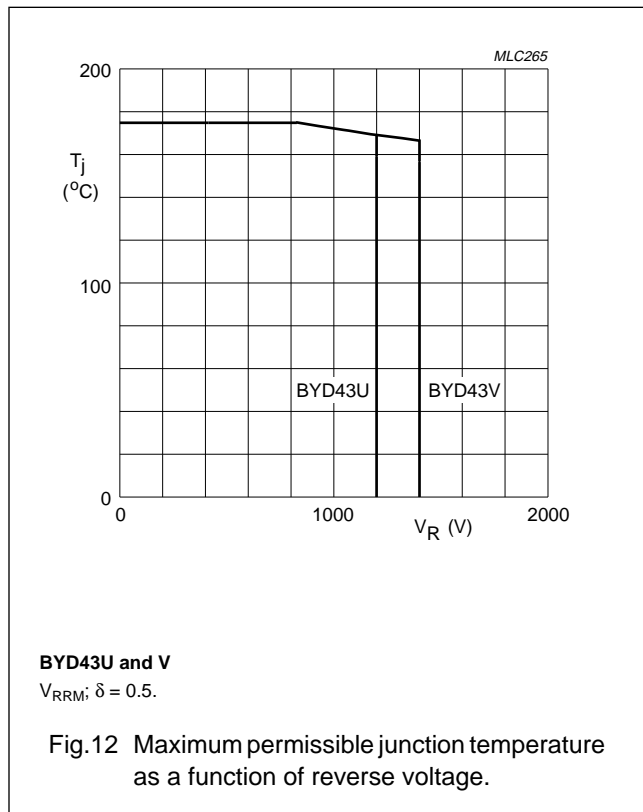
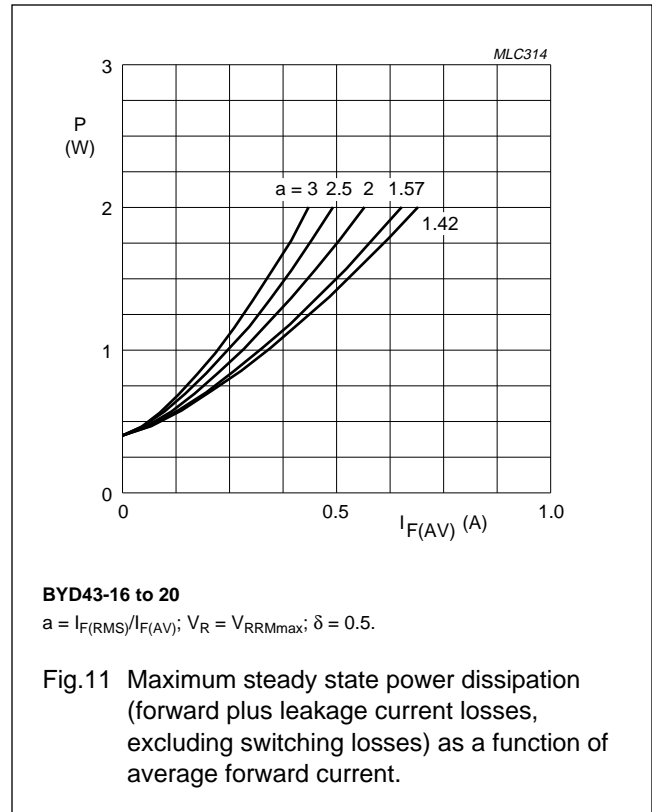
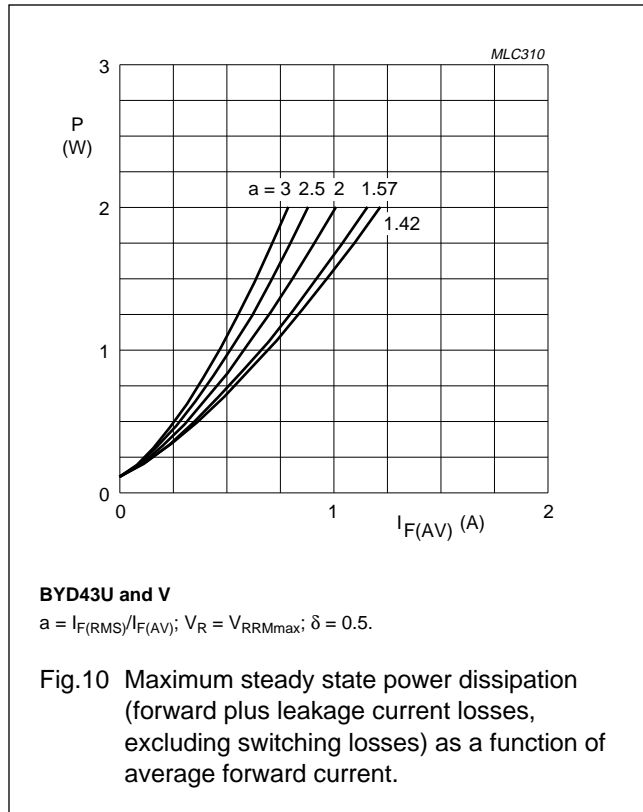

Fast soft-recovery rectifiers

BYD43 series

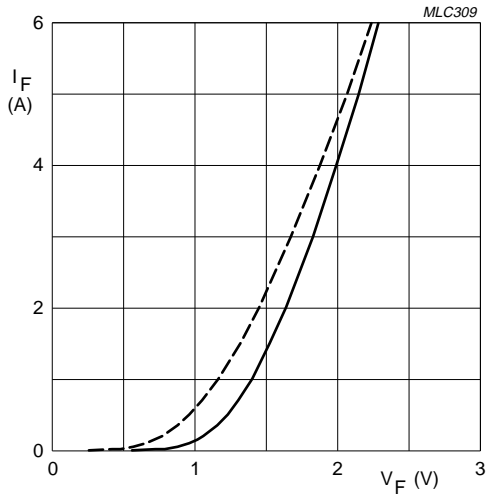

BYD43U and V
 Dotted line: $T_j = 175\text{ °C}$.
 Solid line: $T_j = 25\text{ °C}$.

Fig. 14 Forward current as a function of forward voltage; maximum values.

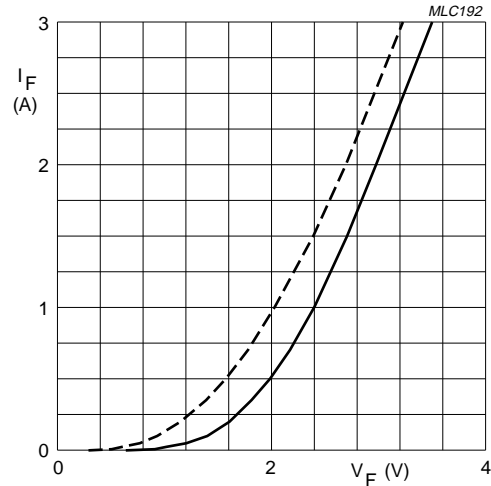

BYD43-16 to 20
 Dotted line: $T_j = 175\text{ °C}$.
 Solid line: $T_j = 25\text{ °C}$.

Fig. 15 Forward current as a function of forward voltage; maximum values.

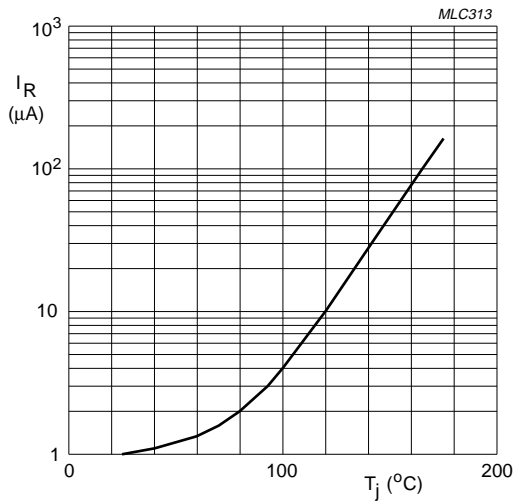

BYD43U and V
 $V_R = V_{RRMmax}$.

Fig. 16 Reverse current as a function of junction temperature; maximum values.

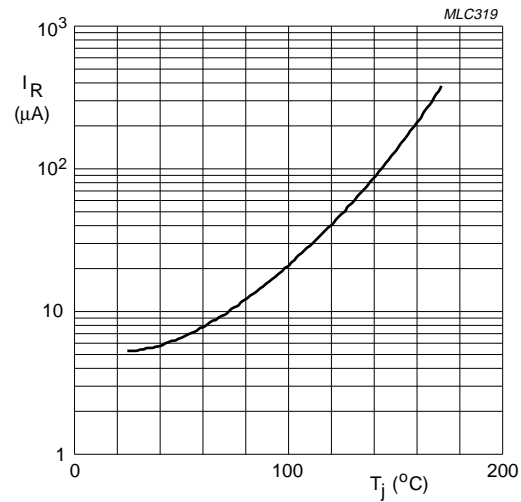

BYD43-16 to 20
 $V_R = V_{RRMmax}$.

Fig. 17 Reverse current as a function of junction temperature; maximum values.

Fast soft-recovery rectifiers

BYD43 series

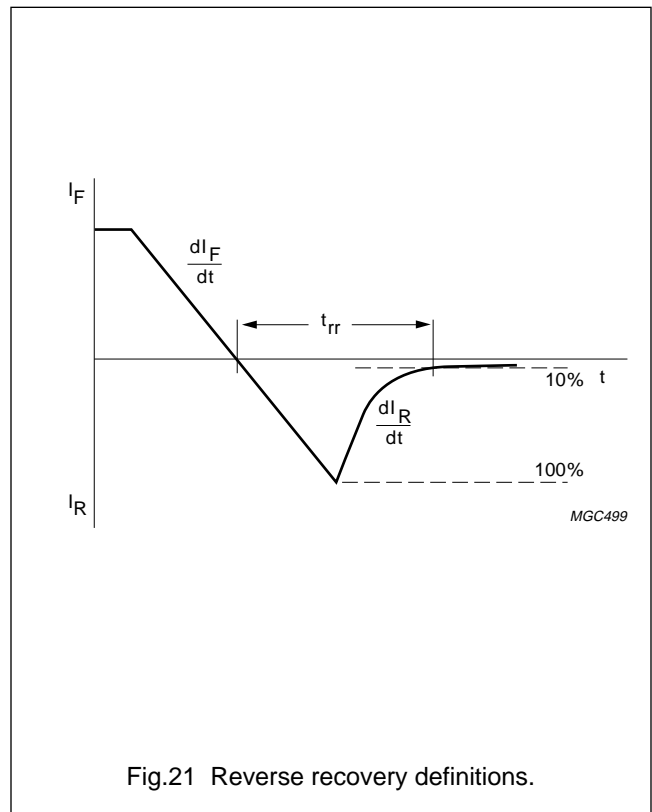
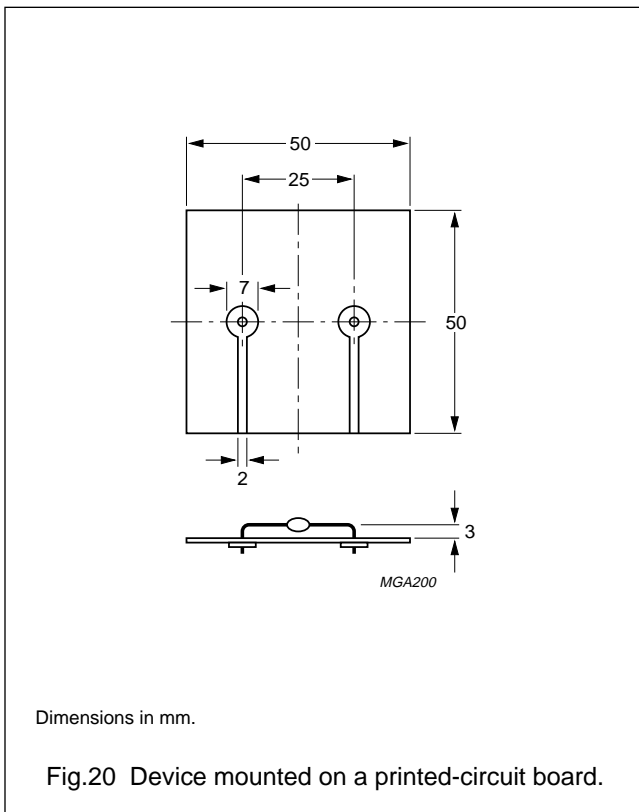
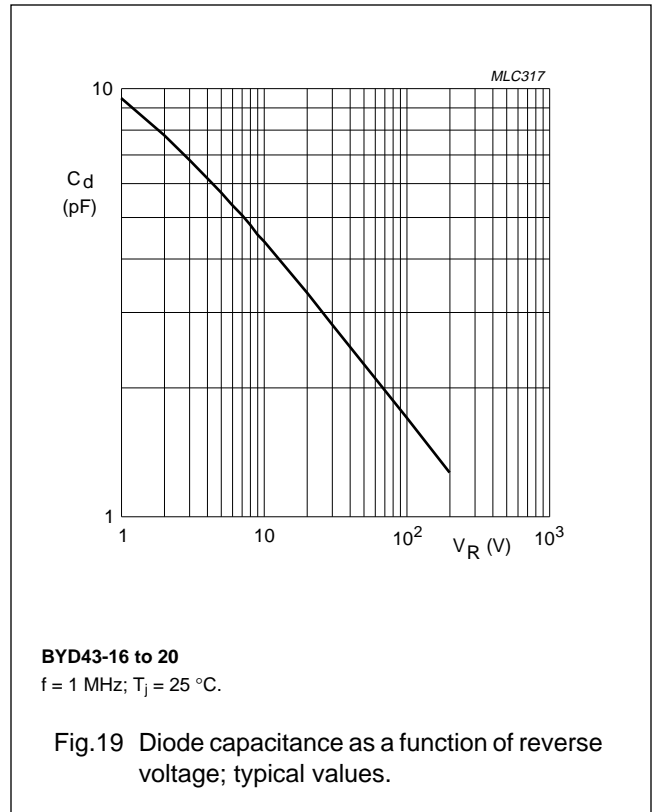
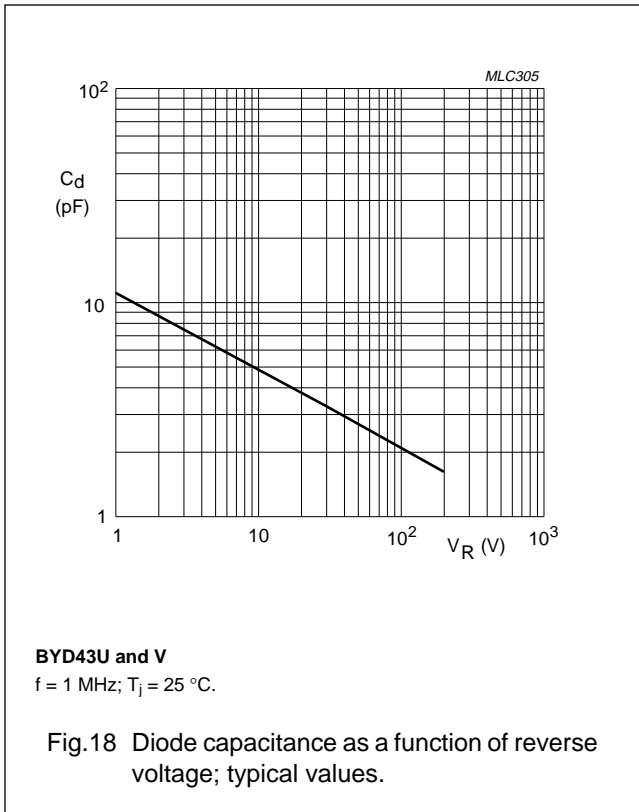

Fast soft-recovery rectifiers

BYD43 series

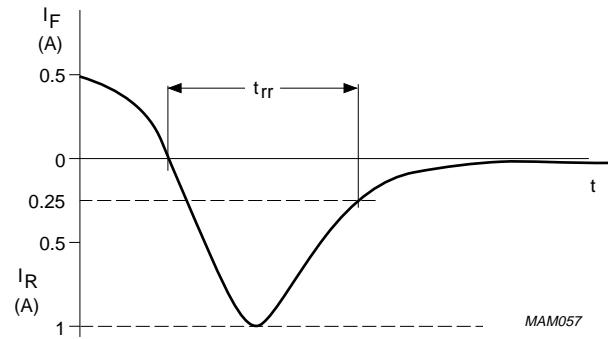
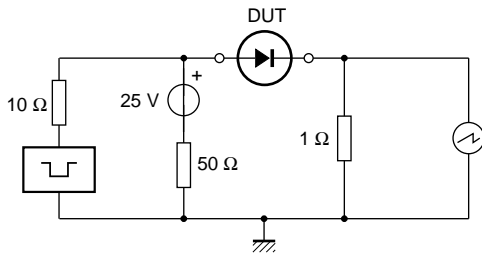

Input impedance oscilloscope: 1 MΩ, 22 pF; $t_r \leq 7$ ns.
 Source impedance: 50 Ω; $t_r \leq 15$ ns.

Fig.22 Test circuit and reverse recovery time waveform and definition.

Fast soft-recovery rectifiers

BYD43 series

PACKAGE OUTLINE

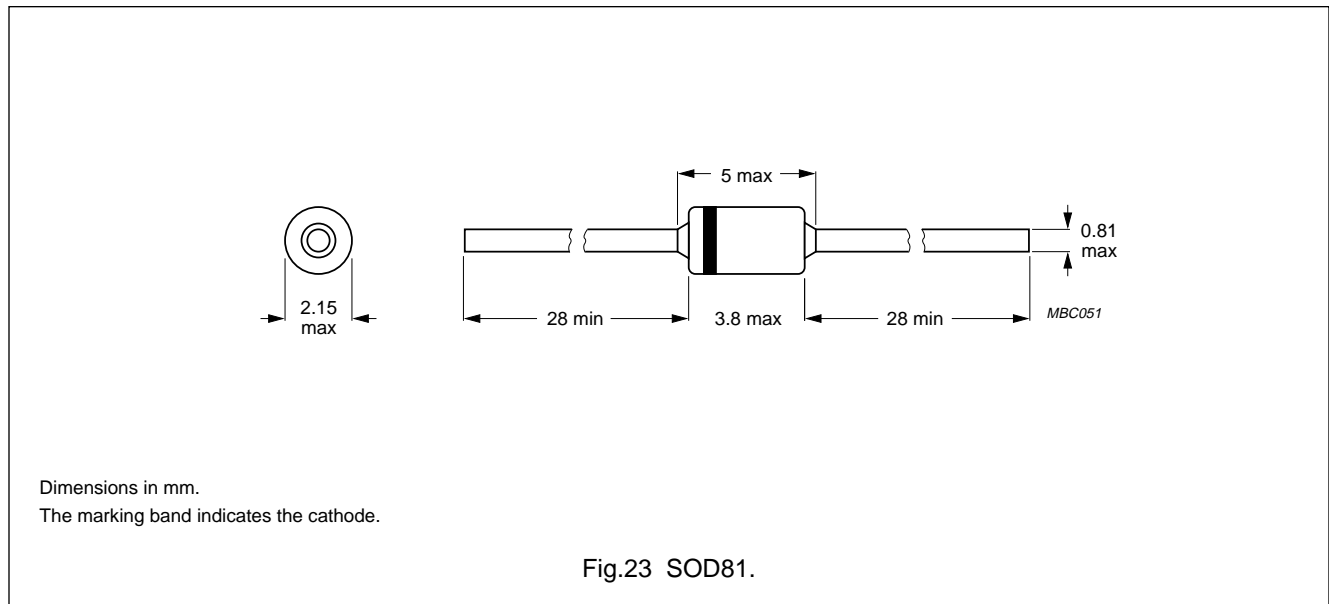

DEFINITIONS

Data Sheet Status	
Objective specification	This data sheet contains target or goal specifications for product development.
Preliminary specification	This data sheet contains preliminary data; supplementary data may be published later.
Product specification	This data sheet contains final product specifications.
Limiting values	
Limiting values given are in accordance with the Absolute Maximum Rating System (IEC 134). Stress above one or more of the limiting values may cause permanent damage to the device. These are stress ratings only and operation of the device at these or at any other conditions above those given in the Characteristics sections of the specification is not implied. Exposure to limiting values for extended periods may affect device reliability.	
Application information	
Where application information is given, it is advisory and does not form part of the specification.	

LIFE SUPPORT APPLICATIONS

These products are not designed for use in life support appliances, devices, or systems where malfunction of these products can reasonably be expected to result in personal injury. Philips customers using or selling these products for use in such applications do so at their own risk and agree to fully indemnify Philips for any damages resulting from such improper use or sale.